

DRAFT
NOT FOR CONSTRUCTION

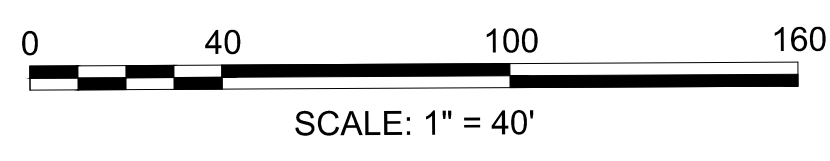

GEOMETRY
ROUNDAABOUT CONCEPT - 130'
SUMMER & FRANKLIN INTERSECTION
DUXBURY, MA



**DUXBURY
SUMMER STREET (ROUTE 53)**

STATE	FED. AID PROJ. NO.	SHEET NO.	TOTAL SHEETS
MA	-	-	-
PROJECT FILE NO.		613269	

TYPICAL SECTIONS - 1

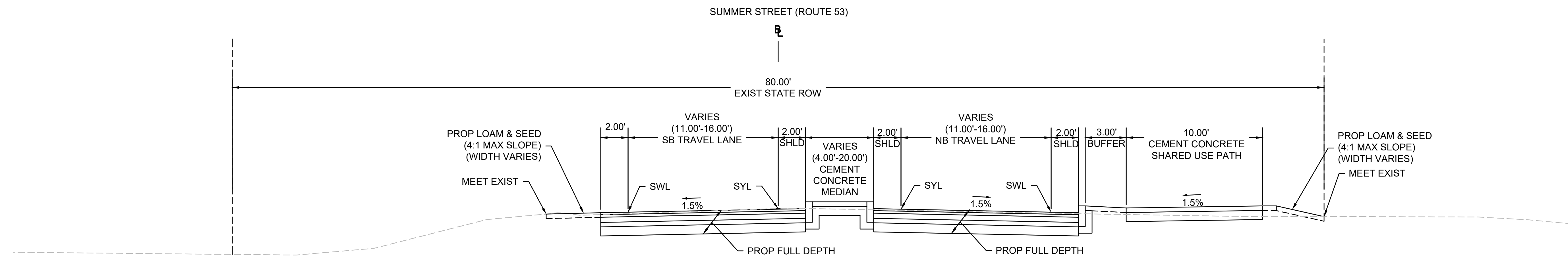

SUMMER STREET (ROUTE 53)
NOT TO SCALE

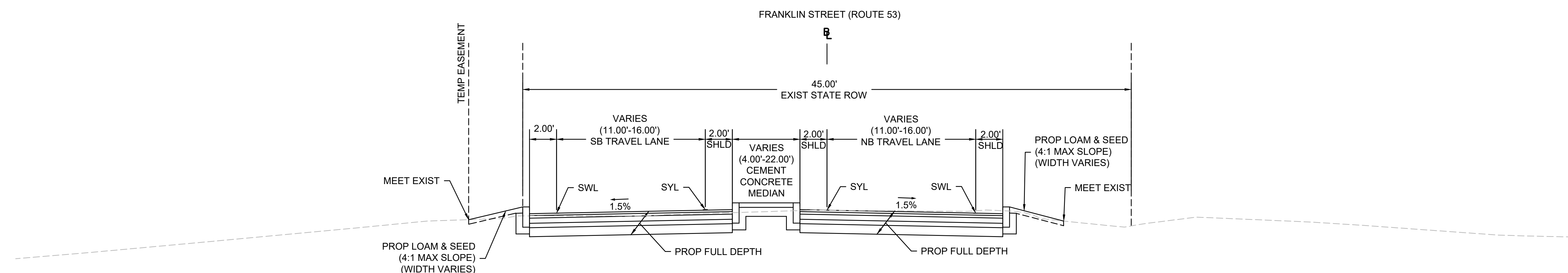

FRANKLIN STREET
NOT TO SCALE

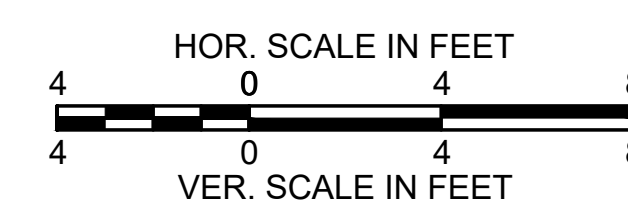

**DUXBURY
SUMMER STREET (ROUTE 53)**

STATE	FED. AID PROJ. NO.	SHEET NO.	TOTAL SHEETS
MA	-	-	-
PROJECT FILE NO.		613269	

TYPICAL SECTIONS - 2

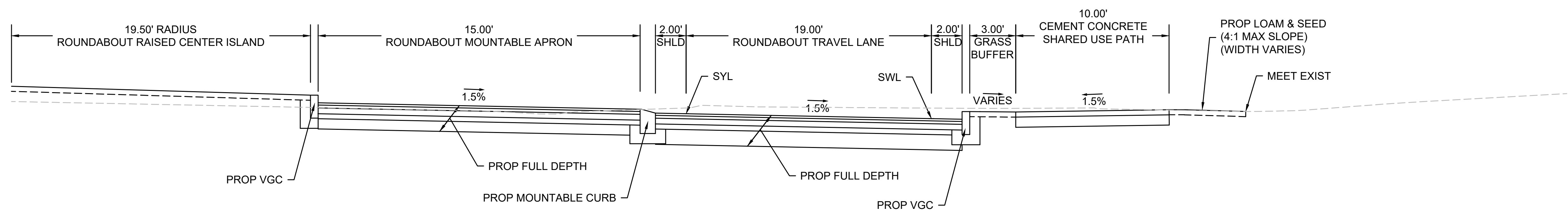

ROUNDABOUT
NOT TO SCALE

**DUXBURY
SUMMER STREET (ROUTE 53)**

STATE	FED. AID PROJ. NO.	SHEET NO.	TOTAL SHEETS
MA	-	-	-
PROJECT FILE NO.		613269	

PROFILES - 1

SUMMER ST

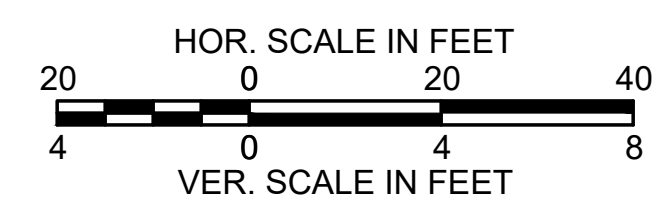
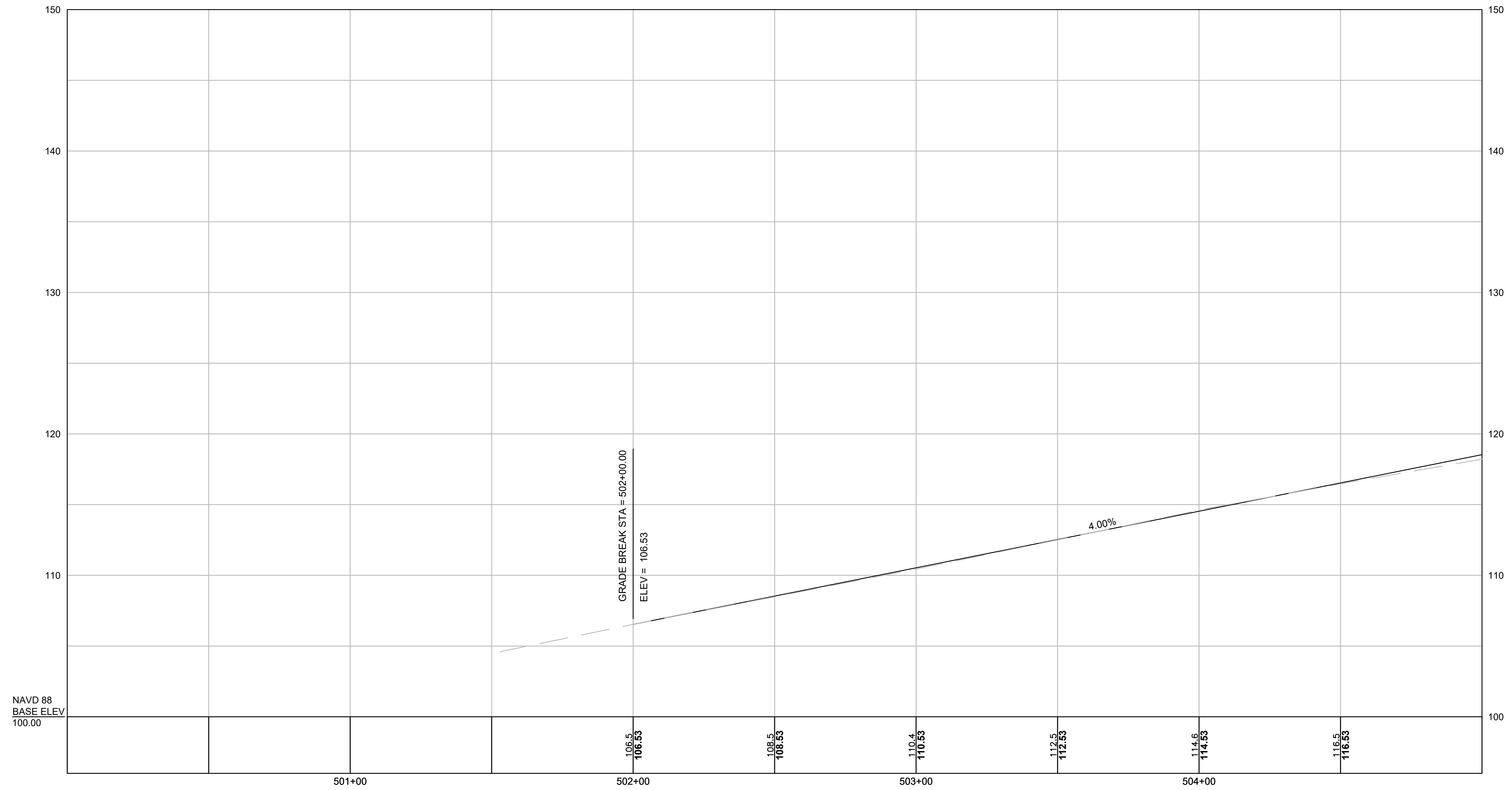

DUXBURY
SUMMER STREET (ROUTE 53)

STATE	FED. AID PROJ. NO.	SHEET NO.	TOTAL SHEETS
MA	-	-	-
PROJECT FILE NO.		613269	

PROFILES - 2

SUMMER ST

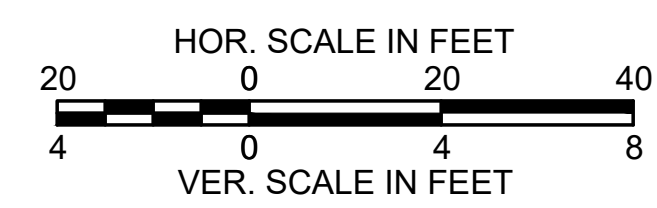
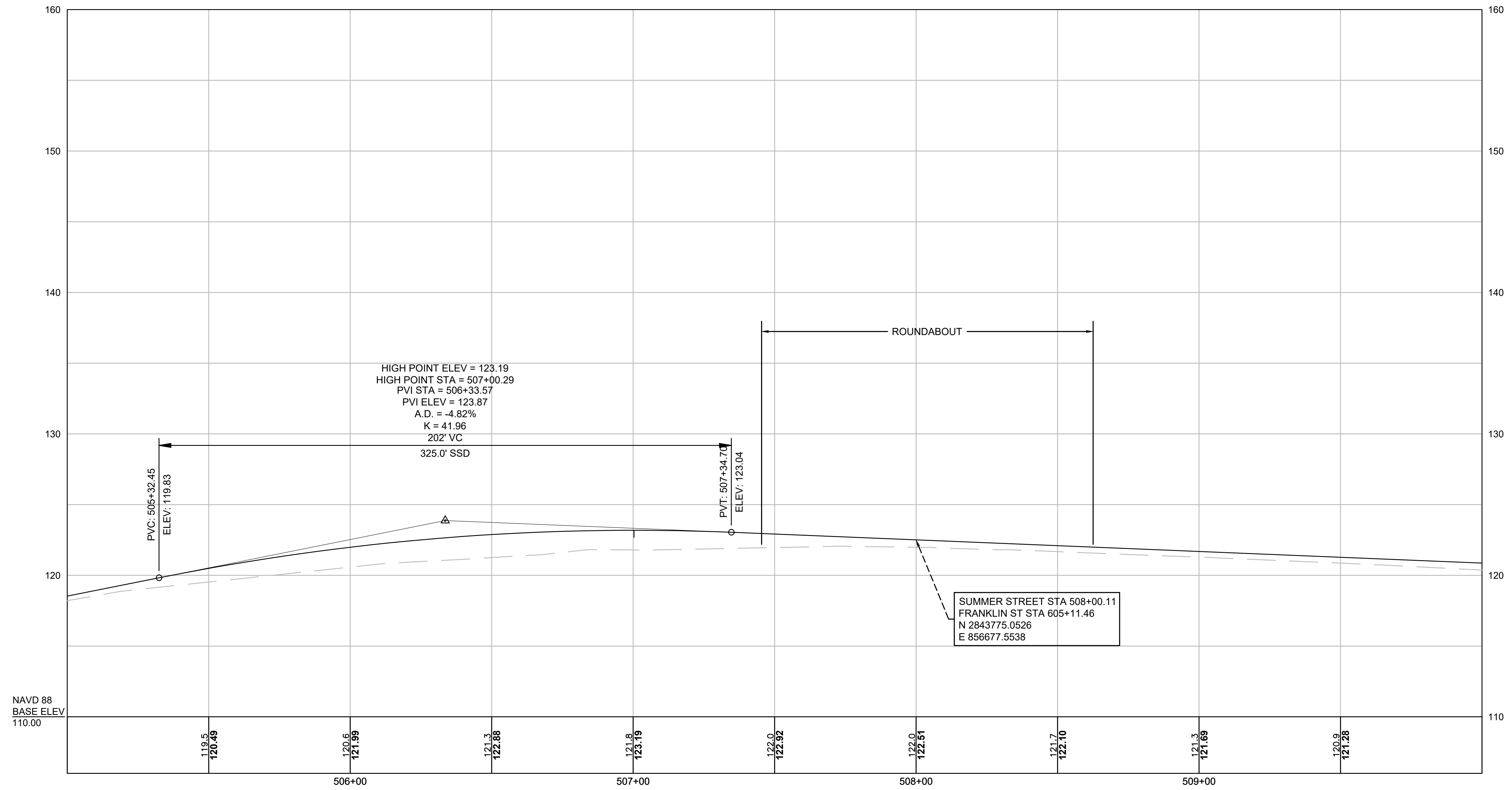

**DUXBURY
SUMMER STREET (ROUTE 53)**

STATE	FED. AID PROJ. NO.	SHEET NO.	TOTAL SHEETS
MA	-	-	-
PROJECT FILE NO.		613269	

PROFILES - 3

SUMMER ST

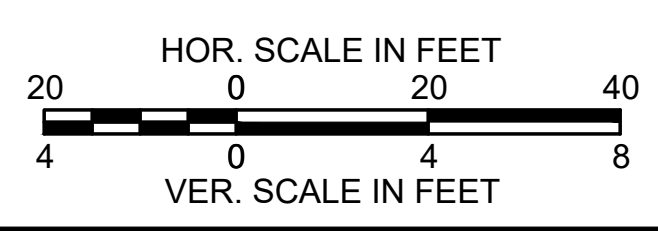
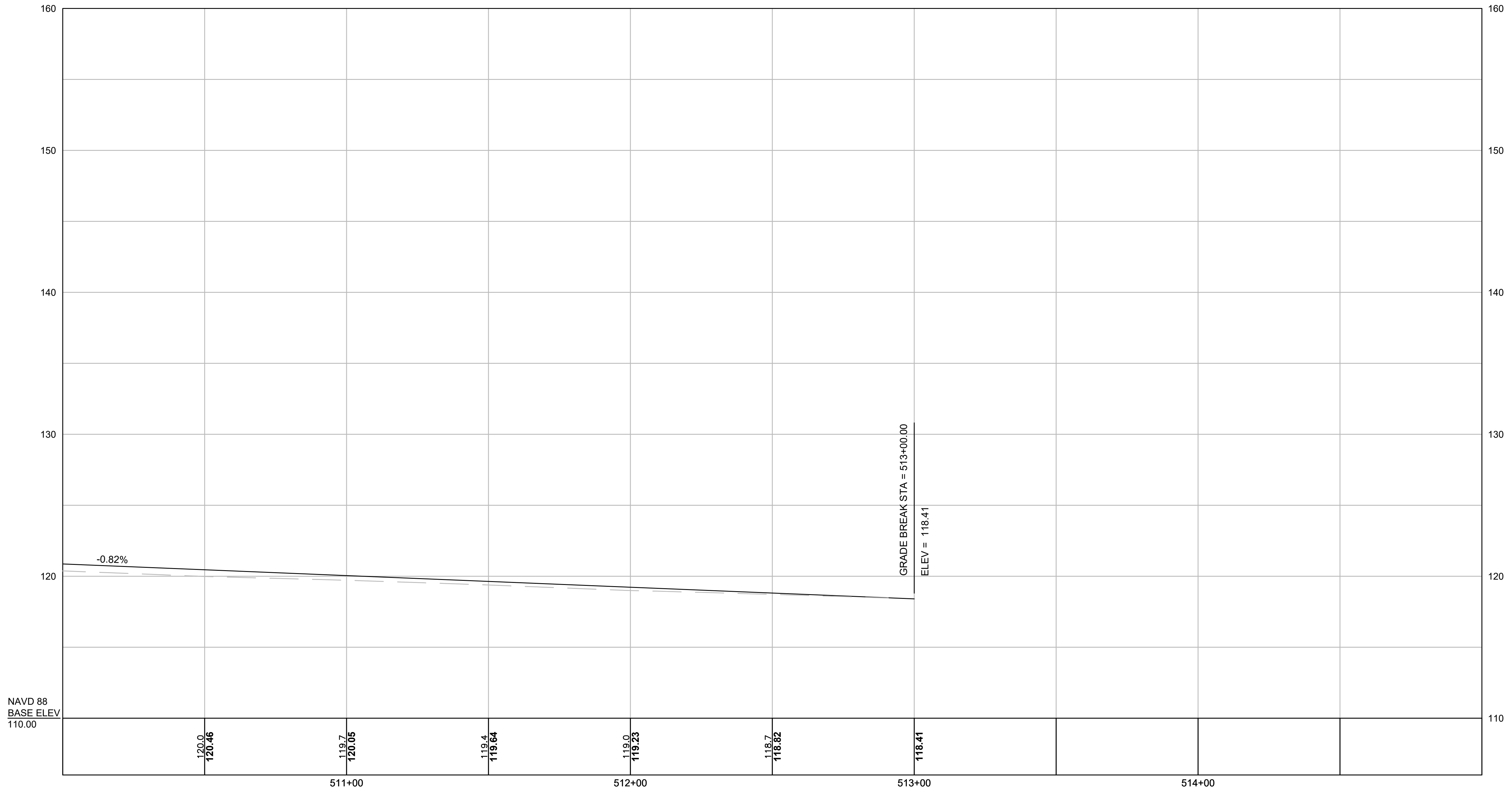

**DUXBURY
SUMMER STREET (ROUTE 53)**

STATE	FED. AID PROJ. NO.	SHEET NO.	TOTAL SHEETS
MA	-	-	-
PROJECT FILE NO.		613269	

PROFILES - 4

FRANKLIN ST

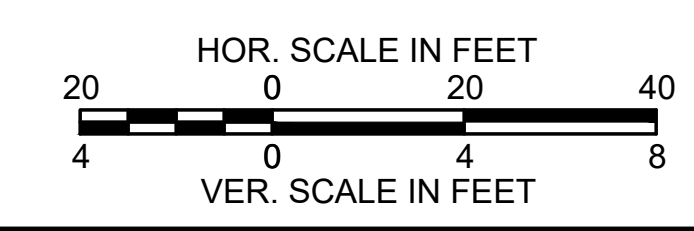
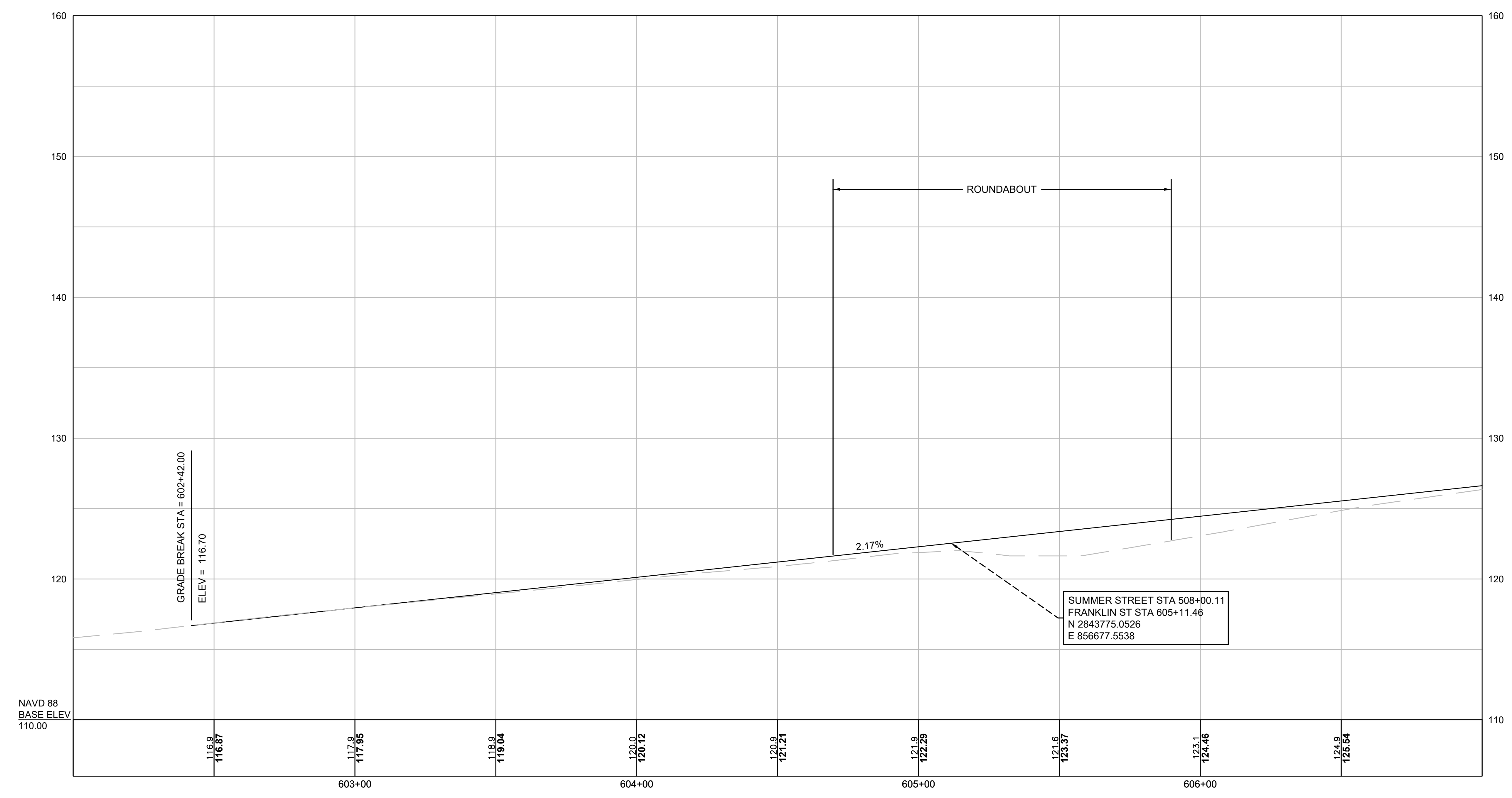

**DUXBURY
SUMMER STREET (ROUTE 53)**

STATE	FED. AID PROJ. NO.	SHEET NO.	TOTAL SHEETS
MA	-	-	-
PROJECT FILE NO.		613269	

PROFILES - 5

FRANKLIN ST

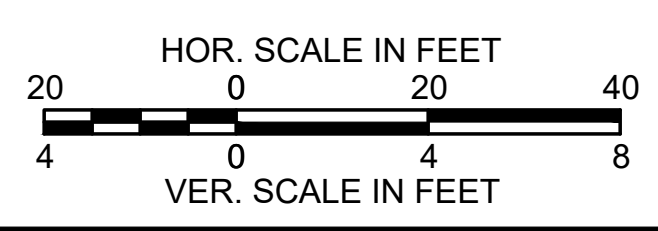
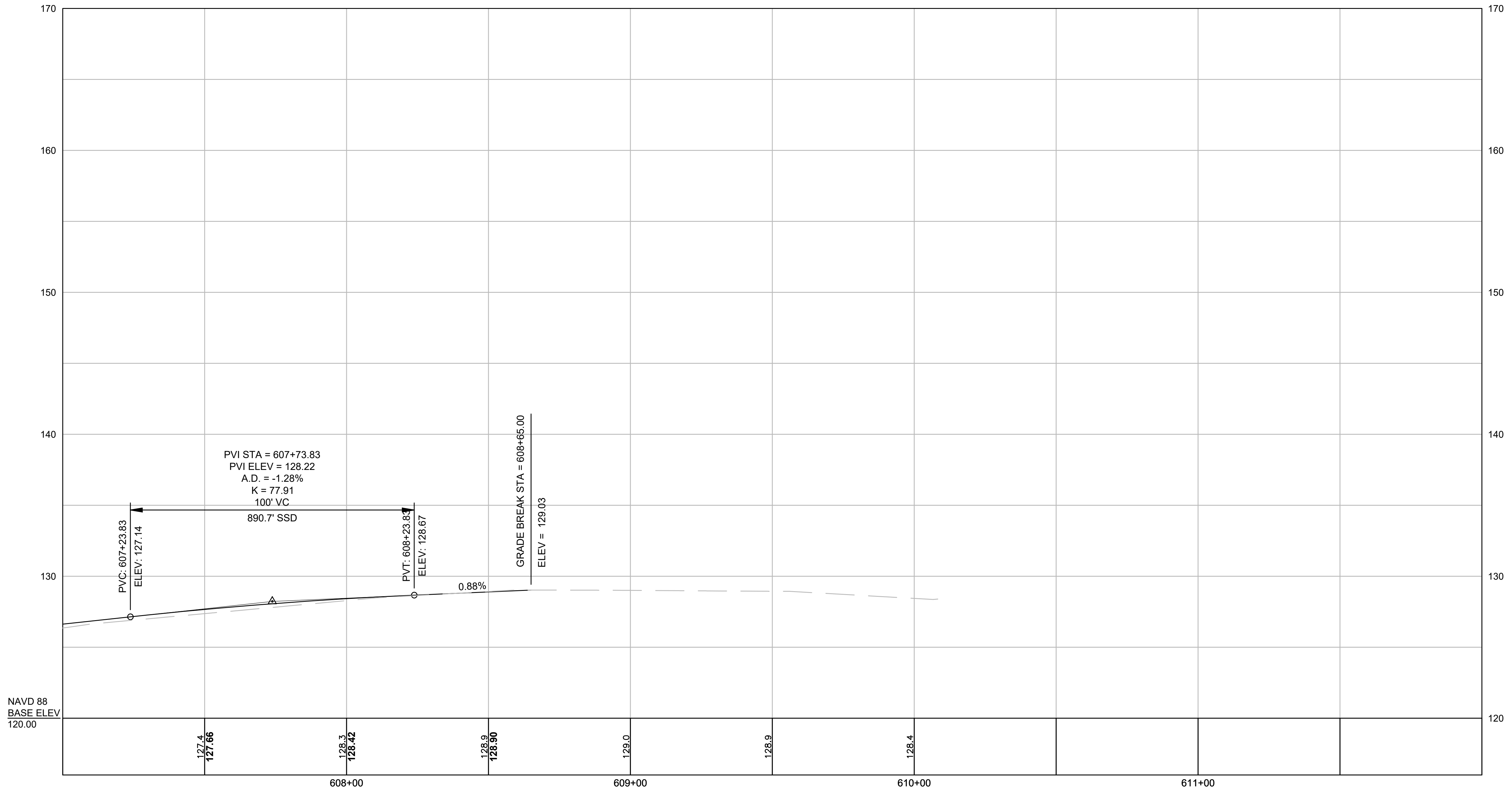

**DUXBURY
SUMMER STREET (ROUTE 53)**

STATE	FED. AID PROJ. NO.	SHEET NO.	TOTAL SHEETS
MA	-	-	-
PROJECT FILE NO.		613269	

CRITICAL CROSS SECTIONS - 1

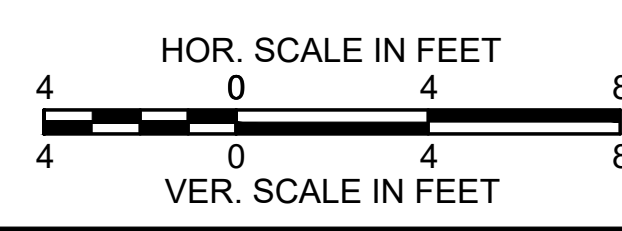
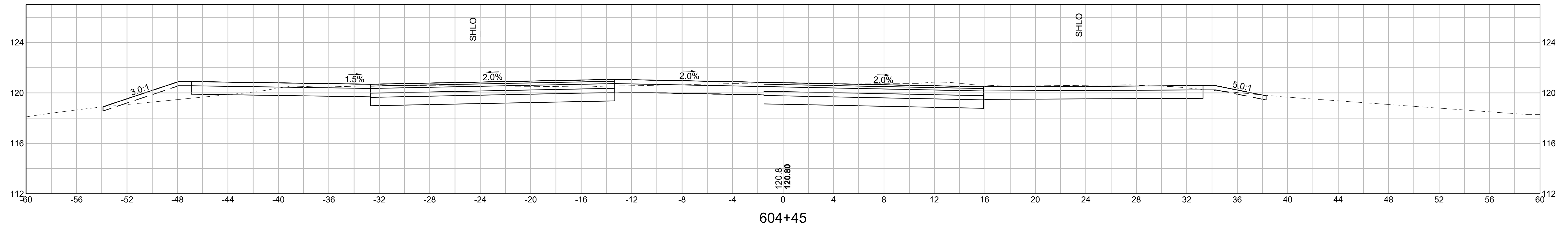
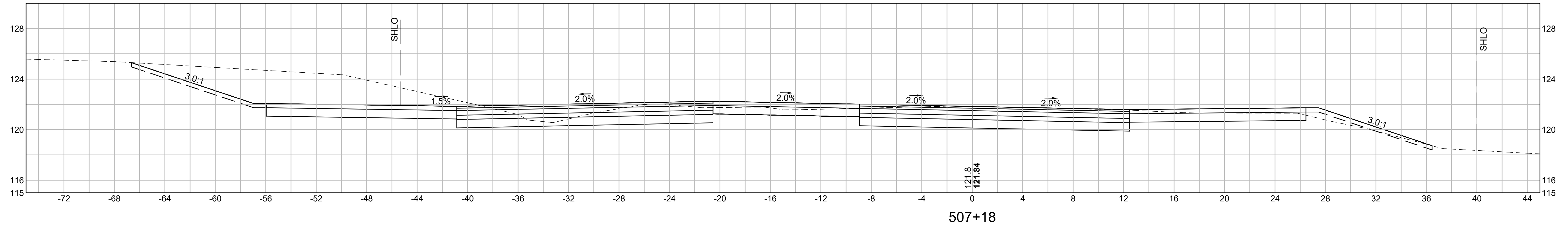

**DUXBURY
SUMMER STREET (ROUTE 53)**

STATE	FED. AID PROJ. NO.	SHEET NO.	TOTAL SHEETS
MA	-	-	-
PROJECT FILE NO.		613269	

CRITICAL CROSS SECTIONS - 2

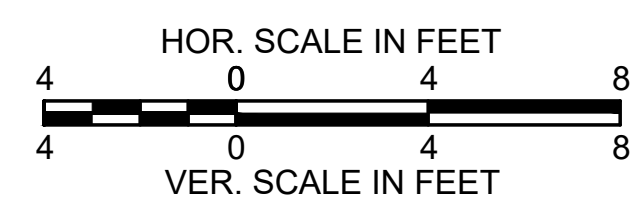
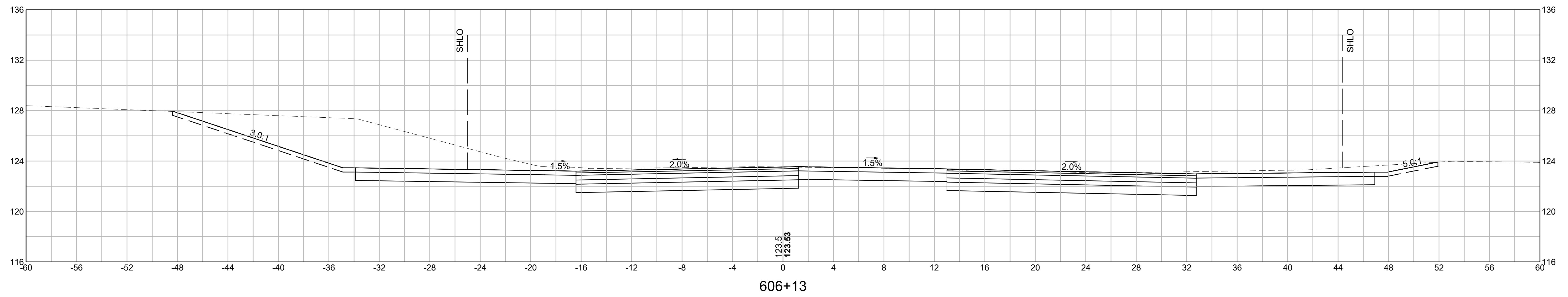
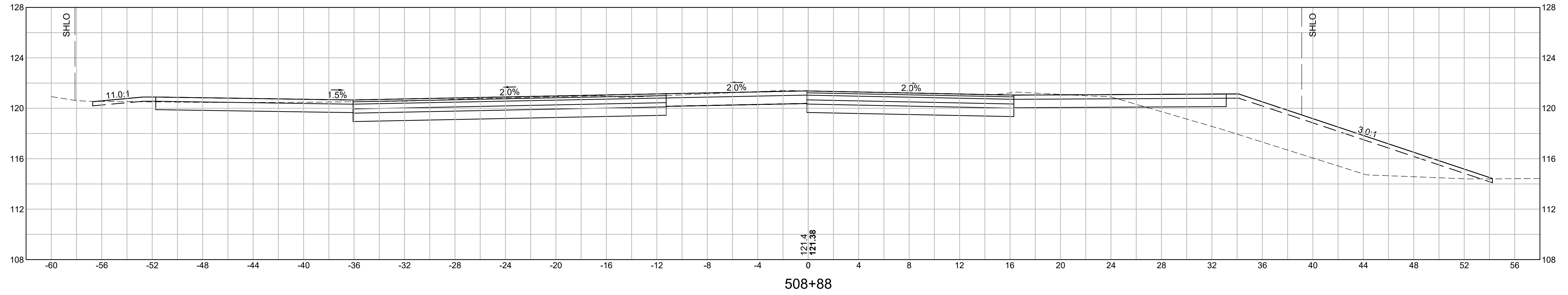

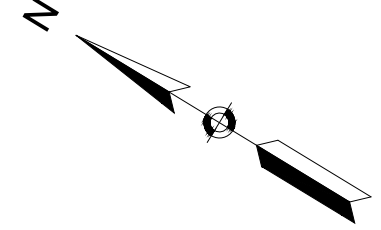

EAST LEG: FRANKLIN STREET			
R1:	141'	V1:	23 MPH
R2:	75'	V2:	18 MPH
D ₂₃ :	X'	V3:	X MPH
R4:	52'	V4:	15 MPH
R5:	141'	V5:	23 MPH

SOUTH LEG: SUMMER STREET			
R1:	93'	V1:	20 MPH
R2:	50'	V2:	15 MPH
R3:	X'	V3:	X MPH
R4:	52'	V4:	15 MPH
R5:	94'	V5:	20 MPH

NORTH LEG: SUMMER STREET			
R1:	137'	V1:	23 MPH
R2:	112'	V2:	20 MPH
D ₂₃ :	X'	V3:	X MPH
R4:	52'	V4:	15 MPH
R5:	78'	V5:	19 MPH

WEST LEG: FRANKLIN STREET			
R1:	135'	V1:	23 MPH
R2:	72'	V2:	17 MPH
D ₂₃ :	X'	V3:	X MPH
R4:	52'	V4:	15 MPH
R5:	69'	V5:	18 MPH

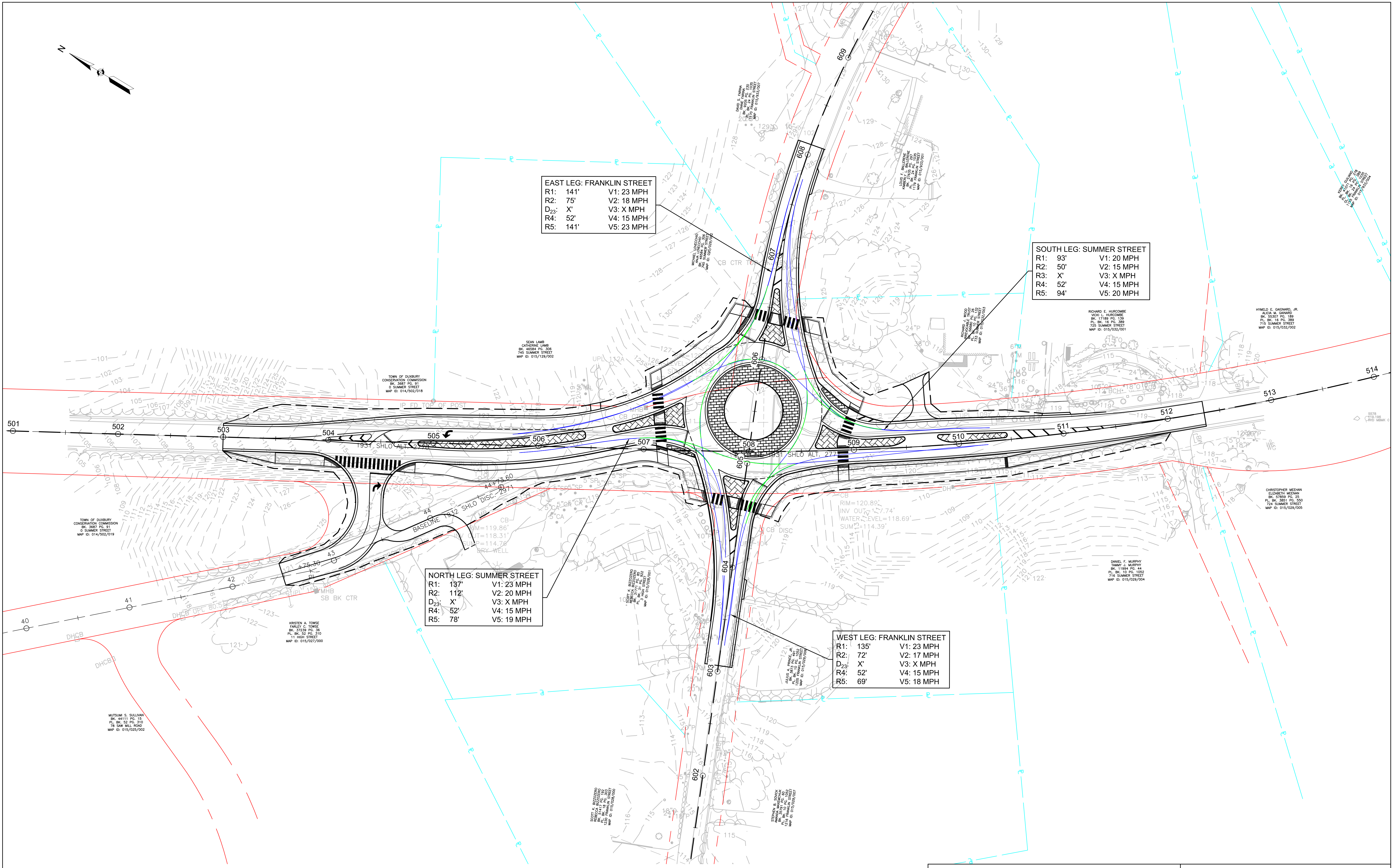

DRAFT
NOT FOR CONSTRUCTION

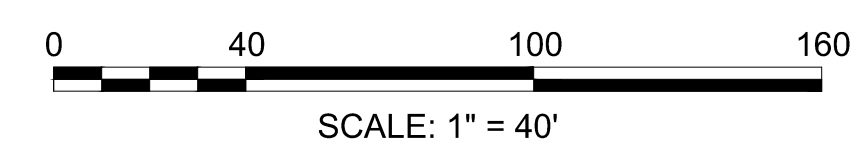

FASTEST PATHS
 ROUNDABOUT CONCEPT - 130'
 SUMMER & FRANKLIN INTERSECTION
 DUXBURY, MA



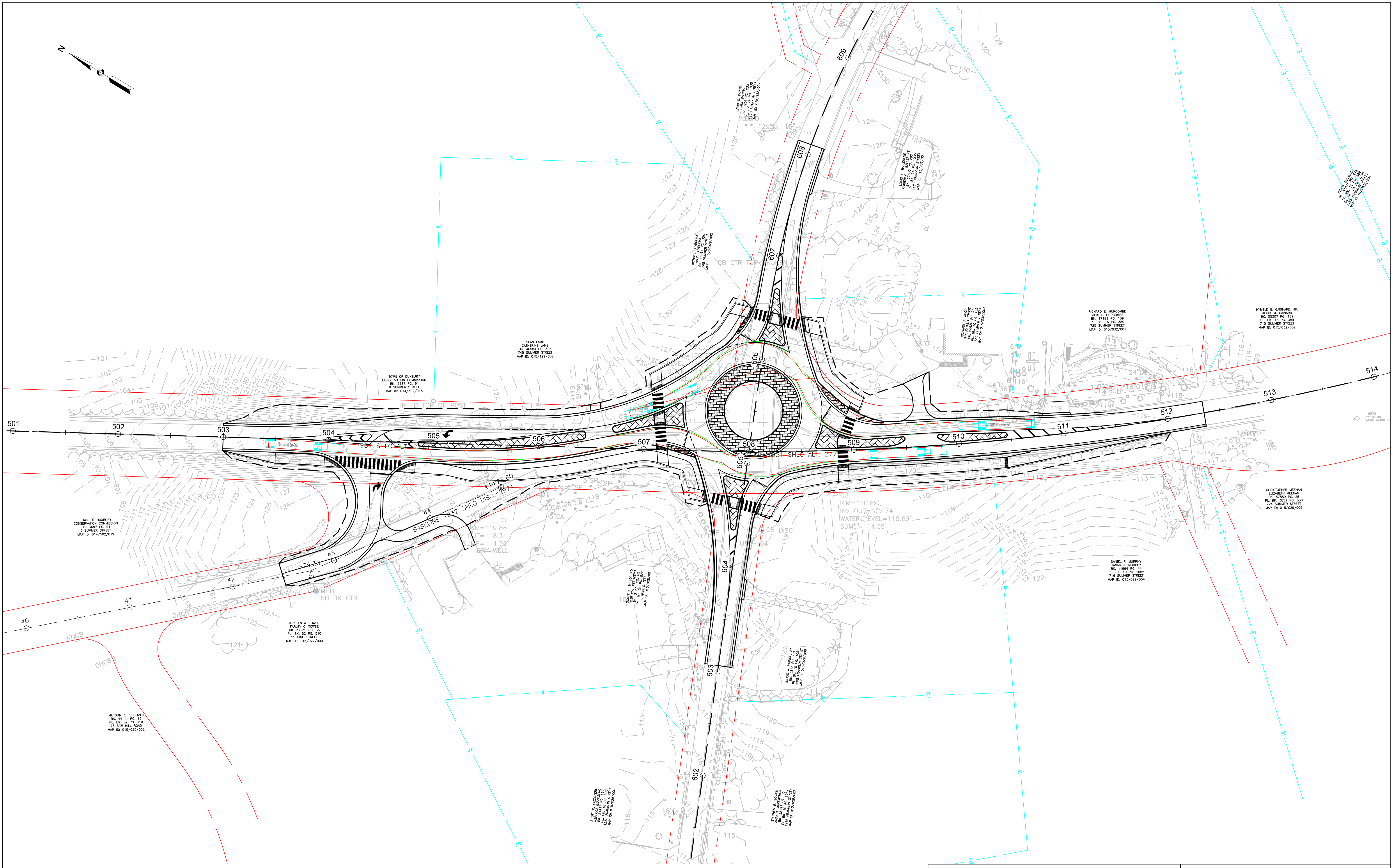
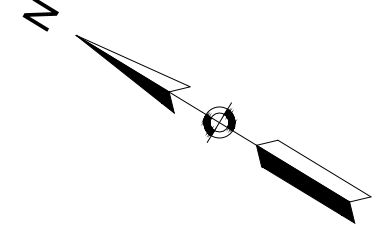

DRAFT
NOT FOR CONSTRUCTION

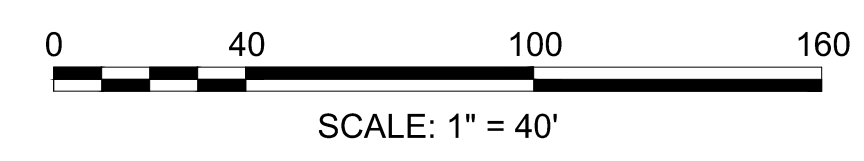

TRUCK TURNS - 1
ROUNDBOUT CONCEPT - 130'
SUMMER & FRANKLIN INTERSECTION
DUXBURY, MA



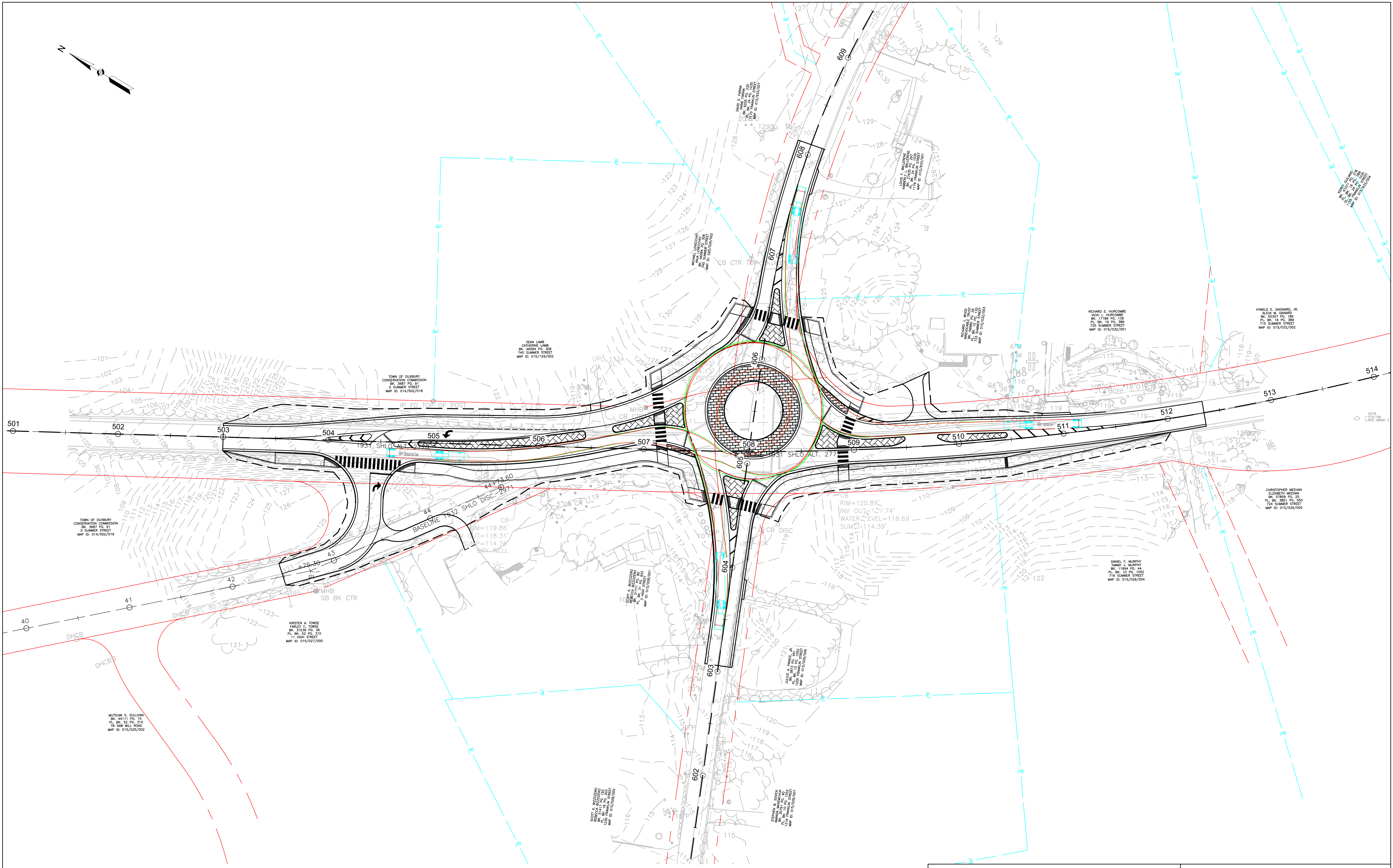
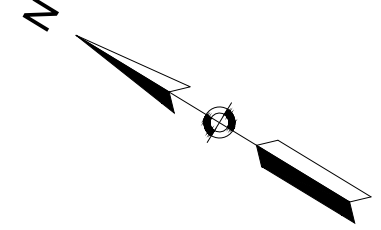

DRAFT
NOT FOR CONSTRUCTION

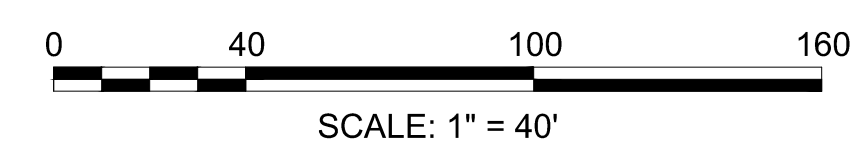

TRUCK TURNS - 2
ROUNDAABOUT CONCEPT - 130'
SUMMER & FRANKLIN INTERSECTION
DUXBURY, MA



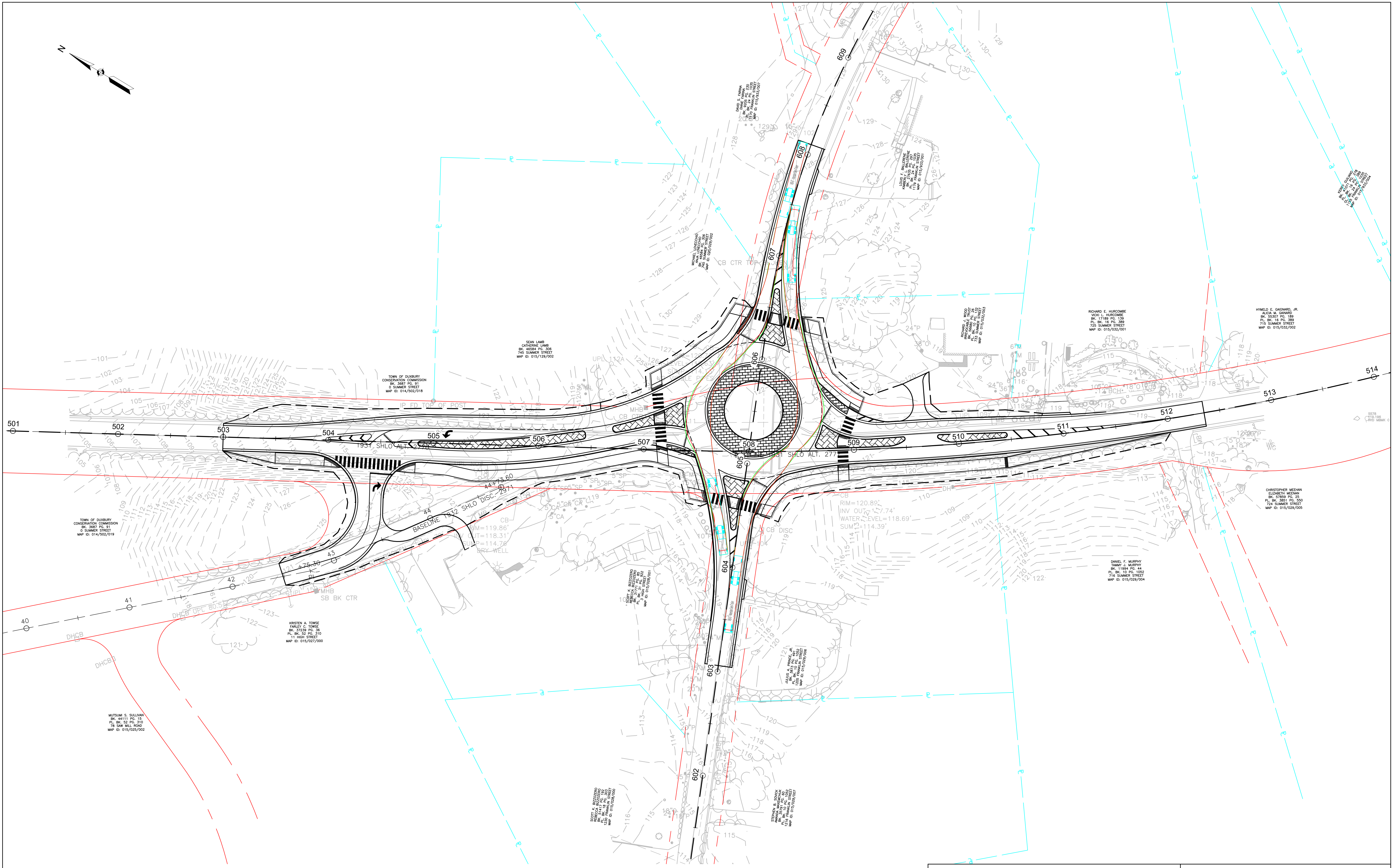
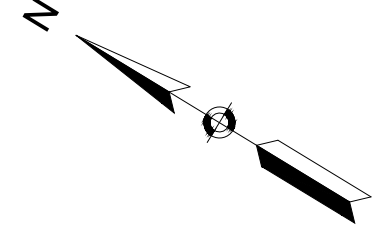

DRAFT
NOT FOR CONSTRUCTION

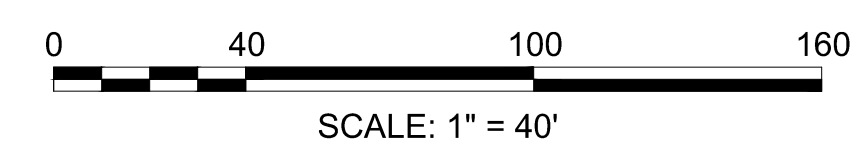

TRUCK TURNS - 3
ROUNDBOUT CONCEPT - 130'
SUMMER & FRANKLIN INTERSECTION
DUXBURY, MA



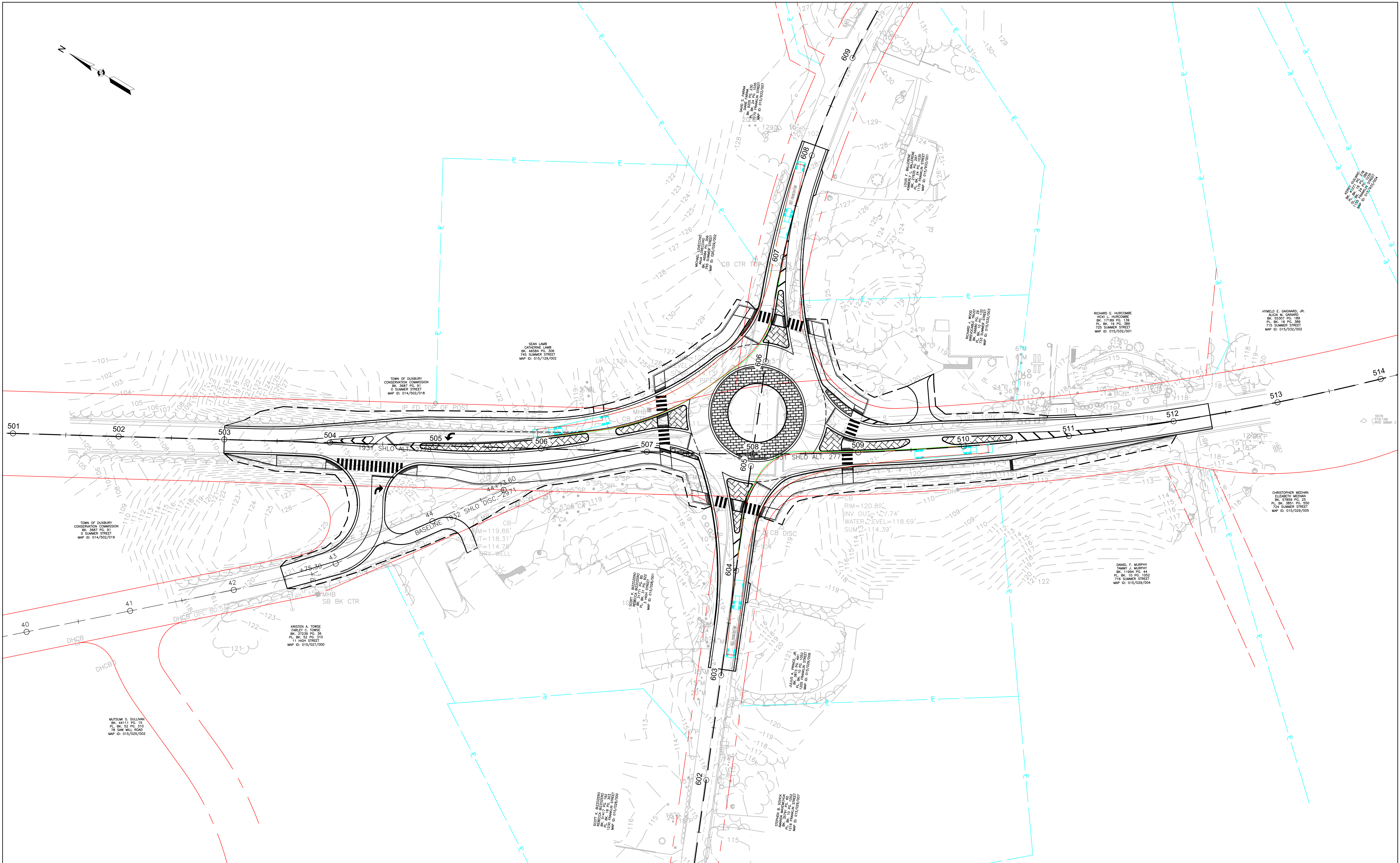
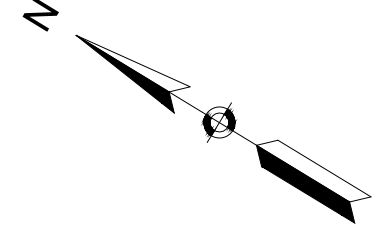

DRAFT
NOT FOR CONSTRUCTION

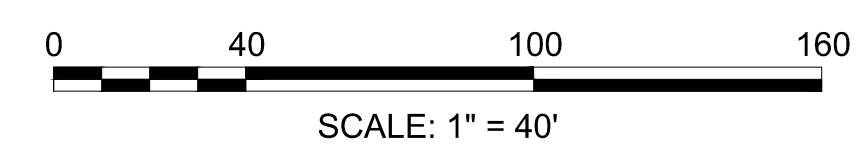

TRUCK TURNS - 4
ROUNDAABOUT CONCEPT - 130'
SUMMER & FRANKLIN INTERSECTION
DUXBURY, MA

