

## TABLE OF CONTENTS

	Page
EXECUTIVE SUMMARY .....	ES-1
TABLE OF CONTENTS .....	i
LIST OF FIGURES .....	.iii
LIST OF TABLES .....	.iii
LIST OF APPENDICES .....	.iii
1.0 INTRODUCTION.....	1-1
1.1 Project Understanding .....	1-1
2.0 DESCRIPTION OF EXISTING SITE CONDITIONS .....	2-1
2.1 Existing Wall Structure .....	2-1
2.2 Existing Subsurface Conditions.....	2-1
2.2.1 Geologic Setting .....	2-1
2.2.2 Subsurface Explorations.....	2-1
2.3 Existing Soil Contamination .....	2-2
2.4 Existing Flood Issues .....	2-2
3.0 SUBSURFACE INVESTIGATION ACTIVITIES .....	3-1
3.1 Subsurface Conditions .....	3-1
3.2 Groundwater .....	3-2
3.3 Geotechnical Laboratory Testing .....	3-2
3.4 Conditions of Existing Canal Wall.....	3-2
3.5 Disposal Characterization Sampling and Analysis .....	3-3
4.0 ENVIRONMENTAL CONSIDERATINOS AND RECOMMENDATIONS .....	4-1
4.1 MCP Regulatory Considerations .....	4-1
4.1.1 13 Wallis Street .....	4-1
4.1.2 24 Caller Street.....	4-2
4.1.3 21 Caller Street.....	4-4
4.1.4 18 Howley Street.....	4-6
4.1.5 166R Main Street .....	4-7
4.2 MCP Environmental Regulatory Summary and Recommendations .....	4-8
5.0 GEOTECHNICAL DESIGN AND CONSTRUCTION RECOMMENDATIONS.....	5-1
5.1 Existing Fill and Organics .....	5-1
5.2 Retaining Walls.....	5-1
5.2.1 Lateral Pressures .....	5-1
5.2.2 Seismic Considerations.....	5-2
5.3 Construction Considerations .....	5-3
5.3.1 Fill Materials and Placement .....	5-3
6.0 WALL ALTERNATIVE ANALYSIS.....	6-1

6.1 Alternative A – Rip Rap Slope.....6-1

6.1.1 Resilience.....6-2

6.1.2 Durability.....6-2

6.1.3 Environmental Impact.....6-2

6.1.4 Constructability & Construction Schedule.....6-2

6.1.5 Right-of-Way.....6-2

6.2 Alternative B – Vegetative Berm Above Rip Rap Slope.....6-2

6.2.1 Resilience.....6-3

6.2.2 Durability.....6-3

6.2.3 Environmental Impact.....6-3

6.2.4 Constructability & Construction Schedule.....6-3

6.2.5 Right-of-Way.....6-3

6.3 Alternative C – Sheet Pile Wall.....6-4

6.3.1 Resilience.....6-4

6.3.2 Durability.....6-4

6.3.3 Environmental Impact.....6-4

6.3.4 Constructability & Construction Schedule.....6-5

6.3.5 Right-of-Way.....6-5

6.4 Alternative D – Cantilever Concrete Retaining Wall.....6-5

6.4.1 Resilience.....6-5

6.4.2 Durability.....6-5

6.4.3 Environmental Impact.....6-5

6.4.4 Constructability & Construction Schedule.....6-5

6.4.5 Right-of-Way.....6-6

6.5 Alternative E – Stone Masonry Wall.....6-6

6.5.1 Resilience.....6-6

6.5.2 Durability.....6-6

6.5.3 Environmental Impact.....6-6

6.5.4 Constructability & Construction Schedule.....6-6

6.5.5 Right-of-Way.....6-7

7.0 REFERENCES INCREMENTAL APPROACH.....7-1

8.0 PERMITTING STRATEGY.....8-1

8.1 Introduction.....8-1

8.2 Environmental Permitting Strategy.....8-2

8.2.1 Alternative A – Rip Rap Slope.....8-2

8.2.2 Alternative B – Vegetative Berm Over Rip Rap Slope.....8-3

8.2.3 Alternative C – Sheet Pile Wall.....8-5

8.2.4 Alternative D – Cantilever Concrete Retaining Wall.....8-7

8.2.5 Alternative E – Stone Masonry Wall.....8-9

8.3 Permitting Summary and Recommendations.....8-10

9.0 COMPREHENSIVE COMPARATIVE MATRIX.....9-1

10.0 CONCLUSIONS.....10-1

11.0 REFERENCES.....11-1



**LIST OF FIGURES**

Figure 1 ..... Locus Plan

Figure 2 ..... Site Plan

**LIST OF TABLES**

Table 1 ..... Summary of Existing Conditions

Table 2 ..... Summary of Subsurface Conditions

Table 3 ..... Summary of Soil Analytical Results - Disposal Characterization

Table 4 ..... Summary of Soil Transportation & Disposal Cost Estimates

**LIST OF APPENICES**

Appendix A ..... 2017 Riverwalk along North River Corridor – South Wall Evaluation

Appendix B ..... Previous Subsurface Explorations – Soil Borings & Photographs

Appendix C ..... 2017 Limited Subsurface Environmental Investigations – Proposed Riverwalk Area

Appendix D ..... Soil Boring and Test Pit Logs – November 2018

Appendix E ..... Geotechnical Analytical Laboratory Report

Appendix F ..... Disposal Characterization Analytical Laboratory Report

Appendix G ..... Geotechnical Engineering Report- GBA, Inc.

Appendix H ..... Typical Cross Sections and Alignments of Alternatives

Appendix I ..... Wall Alternative Cost Estimates

Appendix J ..... Resilience Evaluation Report

Appendix K ..... Summary of Potential Permits

Appendix L ..... Summary Table of Permitting Variables

Appendix M ..... Potential Permitting Schedule

.....

## EXECUTIVE SUMMARY

In 2018, the City of Peabody (the City) was awarded a Municipal Vulnerability Preparedness (MVP) Action Grant by the Massachusetts Executive Office of Energy & Environmental Affairs (MassEEA). The MVP grant will allow the City to explore options for improving the flood resiliency of Peabody Square and was awarded based on a comprehensive project proposal to specifically target a stretch of the North River Canal that will improve flood resilience, address site contamination from historic use as a tannery district and evaluate a park resource and Riverwalk that would enhance public access and vitality of the area.

The proposed Riverwalk will be approximately 1,600 feet in length, following along the canal in the urban industrial section of downtown Peabody from approximately Wallis Street to Howley Street. The existing wall on the south side of the canal over the length of the proposed Riverwalk varies drastically in condition from good to poor. In 2017, Weston & Sampson determined that prior to the construction of the Riverwalk, the south canal wall would need to be repaired / replaced in order to support the construction of the proposed Riverwalk.

Weston & Sampson, on behalf of the City, has performed subsurface explorations immediately behind the Canal wall to obtain back of existing wall information, including wall type, dimensions, and subsurface conditions. Using that information, Weston & Sampson was able to perform preliminary geotechnical and structural analyses to evaluate repair/replacement design alternatives for the wall. Additional grant activities also included limited environmental sampling activities to better understand potential regulatory obligations under the Massachusetts Contingency Plan (MCP), 310 CMR 40.0000.

Weston & Sampson has developed five (5) design repair/replacement alternatives for the south canal wall to support the construction of a Riverwalk and improve flood resilience along the North River Canal. Wall alternatives include options for replacing the current wall with a new wall, as well as green options like providing protection with an earthen berm. Preliminary engineering cost estimates for each alternative have been provided. Weston & Sampson then conducted a preliminary analysis to evaluate the five (5) wall alternatives based on factors such as resiliency, anticipated durability, environmental impact, permitting, schedule, and costs. This was used to rank and prioritize alternatives for the wall.

Based upon the findings and comparative evaluations presented in this report, Alternative C – Sheet Pile Option 2 with Sloped Bank ranked as the highest scoring alternative. This alternative would provide the most additional flood storage with relatively low total cost and minimal maintenance when compared to other alternatives. In addition, Alternative C – Sheet Pile Option 2 with Sloped Bank requires a reasonable easement width from private property owners, would allow for the design of an adjacent Riverwalk, does not require any material to be dredged from the canal and had the highest total permitting favorability.

However, while this alternative works from a conceptual engineering and permitting evaluation perspective, Alternative C – Option 2 may not be feasible along the entire length of the wall due to existing structures and grade and may require a limited length of one of the other wall alternatives to be considered. The feasibility in such areas will need to be further evaluated during the preliminary design process and may depend on other factors such as property easements or acquisition potential.

Other well-scoring alternatives were: Alternative C - Sheet Pile Wall - Option 1; Alternative B - Vegetative Berm - Option 1; and Alternative A - Rip Rap - Option 1. The highest-ranking wall option, Alternative C - Sheet Pile Wall - Option 2 with Sloped Bank, combines all the favorable qualities of Alternatives A and B with the favorable qualities of Alternative C - Sheet Pile - Option 1 and provides the highest percentage of potential parcel protection for all six flood-climate change projection scenarios.

## 1.0 INTRODUCTION

The City of Peabody suffers from recurring flooding which is expected to worsen from climate change, including sea level rise and increased precipitation frequency and intensity. In 2018, the City of Peabody (the City) was awarded a Municipal Vulnerability Preparedness (MVP) Action Grant by the Massachusetts Executive Office of Energy & Environmental Affairs (MassEEA). The MVP grant will allow the City to explore options for improving the flood resiliency of Peabody Square and was awarded based on a comprehensive project proposal to specifically target a stretch of the North River Canal that will improve flood resilience, address site contamination from historic use as a tannery district and evaluate a park resource and proposed Riverwalk that would enhance public access and vitality of the area. The North River Canal is a straightened and walled reach of the North River connecting Peabody Square to the tidal reach of the North River near the Salem-Peabody municipal boundary. The North River drainage basin discharges into Salem Sound

The proposed Riverwalk will be approximately 1,600 feet in length, following along the canal (i.e. Proctor Brook) in the urban industrial section of downtown Peabody from approximately Wallis Street to Howley Street. The south side of the canal abuts six (6) privately owned properties (from west to east: 13 Wallis Street, 24 Caller Street, [Caller Street crossing], 21 Caller Street, 18 Howley Street, 166R Main Street, and Massachusetts Bay Transit Authority (MBTA) property]. The existing wall on the south side of the canal over the length of the proposed Riverwalk varies drastically in condition from good to poor. In 2017, Weston & Sampson determined that prior to the construction of the Riverwalk, the south canal wall would need to be repaired / replaced in order to support the construction of the proposed Riverwalk.

This report presents the results of Weston & Sampson's geotechnical and structural feasibility studies that were conducted in the target area along the North River Canal as part of MVP Grant activities. The purpose of this engineering evaluation was to preliminarily explore subsurface conditions and assess geotechnical, environmental, structural, and regulatory permitting considerations for repair/replacement alternatives for the North River Canal south wall to support the proposed Riverwalk.

The recommendations presented in this report are based on Weston & Sampson's understanding of the proposed project as described herein, subsurface conditions encountered at discrete exploration locations, and the provisions of the Limitations, provided in Section 11, of this report. Additional investigations, testing, and recommendations will be necessary for final design.

### 1.1 Project Understanding

The project site is in an urban industrial area of Peabody, between Wallis and Howley Streets, and crosses Caller Street, as shown in **Figure 1 – Site Locust**. The south side of the North River Canal along the project limits abuts six (6) privately owned properties, from west to east: 13 Wallis Street, 24 Caller Street, [Caller Street crossing], 21 Caller Street, 18 Howley Street, 166 Main Street (R), and MBTA property. Refer to **Figure 1** and **Figure 2 – Site Plan** for the property limits, and **Table 1 – Summary of Existing Conditions** for a summary of existing conditions within the project area. Construction of the park and Riverwalk will require property acquisition or easements on these private properties.

The south canal wall along the length of the project limits consists of multiple sections including earthen embankment (or possible buried wall), a stacked timber railroad tie structure behind an earth embankment, reinforced concrete, granite blocks, or stone or stone rubble sections. Wall heights range from about 4 to 6 feet above the canal bottom. The wall's condition varies over its length, ranging from good, in need of minor or no repairs, to poor, requiring full or partial reconstruction. Refer to Weston & Sampson's report titled "Riverwalk along North River Corridor – South Wall Evaluation," dated June 2,

2017, in **Appendix A** for detailed description of the existing wall types and conditions along the project alignment.

The North River Canal has a history of flooding. The overall goal of the MVP grant project is to evaluate and incorporate resilient design measures to provide flood protection during storm events, which may include floodwater storage, increased canal wall height, and/or widening of the canal.

Proposed site development plans, including site grading, canal wall alignment and proposed elevations, were not developed at the time of this report.

## 2.0 DESCRIPTION OF EXISTING SITE CONDITIONS

### 2.1 Existing Wall Structure

In May and June of 2017, Weston & Sampson documented the existing conditions of the south wall in a report titled “Riverwalk along North River Corridor – South Wall Evaluation,” dated June 2, 2017. In the report, Weston & Sampson recommended repair or replacement to sections of the wall for support of new loads associated with the proposed Riverwalk. The visual inspection performed on the south wall of the North River Corridor revealed that the wall’s condition varies drastically over its length. Conditions range from “good,” which need minor or no repairs, to “poor,” which require full or partial reconstruction. Causes of deterioration include waterflow, overgrown vegetation (roots), and changes in the surrounding land conditions due to lack of maintenance. Materials used in construction of the wall vary along the wall’s length and include earth embankment or buried wall, a timber tie structure behind earth embankment, reinforced concrete, granite blocks, and stone or stone rubble.

### 2.2 Existing Subsurface Conditions

#### 2.2.1 Geologic Setting

Based on information available from the Massachusetts Office of Geographic Information (MassGIS), surficial geology conditions at the site are mapped as fine glaciomarine deposits overlying thin till and bedrock at depths less than 50 feet. Bedrock in the area of the site is mapped as the Peabody Granite formation. The nearest mapped bedrock outcrops are located approximately a quarter mile from the site, north of the North River Canal.

#### 2.2.2 Subsurface Explorations

A total of ten (10) borings and five (5) test pits were completed in the past during previous subsurface explorations in the area. The following studies provide subsurface data relevant to our geotechnical assessment. The explorations are described below.

##### 2002 Explorations by Geotechnical Services, Inc:

Six (6) borings, herein referred to as B-1(GSI) through B-6(GSI), were completed at the 13 Wallis Street property between October 31 and November 4, 2002 for a multi-family housing development proposed at the time. Boring depths ranged from 17 to 40 feet. The borings were performed by New Hampshire Boring, Inc. (now New England Boring Contractors) of Derry, New Hampshire, and logged by Geotechnical Services, Inc. (GSI) of Goffstown, New Hampshire. Approximate boring locations are shown in **Figure 2**, and the boring logs prepared by GSI are included *in Appendix B – Previous Subsurface Explorations – Boring Logs*.

##### 2007 Explorations by Weston & Sampson:

Weston & Sampson explored subsurface conditions in the project area by advancing four (4) borings (WS-1 through WS-4) between March 21 and 23, 2007 during a previous phase of the North River Canal project. The borings were advanced to depths up to 41 feet below grade at the approximate locations shown on **Figure 2**. Geologic Earth Explorations, Inc of Norfolk, MA performed the borings using drive and wash drilling methods. Boring logs from the 2007 explorations are included in **Appendix B**.

The 2007 explorations also included five (5) test pits (TP-1 through TP-5) to observe the back of the canal wall. Test pits TP-1 through TP-4 were located at the north wall of the canal, outside of the current project area. TP-5 was located within the project area at 13 Wallis Street, at the approximate location shown on **Figure 2** (labelled TP-5(2007) on the figure). Photographs showing the conditions observed

in the test pit are included in *Appendix B*.

### 2.3 Existing Soil Contamination

There is known or suspected soil contamination along the proposed Riverwalk area that will need to be addressed as part of proposed wall repair activities and construction of the Riverwalk. Most of the area was formerly a tannery and it has known and potential environmental impacts. Weston & Sampson, on behalf of the City, conducted limited subsurface environmental assessments at several of the properties within the proposed Riverwalk area in 2017. Copies of the reports are provided in Appendix C - 2017 Limited Subsurface Investigations – Proposed Riverwalk Area. Additional information regarding known, existing current environmental conditions and recommendations to comply with the requirements of the Massachusetts Contingency Plan (MCP) are provided in Section 4.0 – Environmental Considerations and Recommendations.

### 2.4 Existing Flood Issues

The City of Peabody has suffered from recurring flooding events since the 1950's, with the most significant flooding occurring downtown in Peabody Square. Significant floods occurred in 1954, 1968, 1979, 1987, 1996 and 2006. In the past, flooding was largely attributed to post-WWII development and decreased discharge capacity of watercourses in downtown Peabody. However, flooding events have become more frequent with climate change. As noted in the 2008 Preliminary Design of Flood Mitigation Facilities for Peabody Square Area Report, developed for the City, Peabody experienced flooding in October 1996, June 1998, March 2001, April 2004, and May 2006. Three of these events were declared Federal Disasters and caused significant impacts to public safety and public health, substantial property damage, and widespread economic losses. Major transportation arterials that connect to I-95 and MA Routes 128 and 114 as well as commercial rail service were closed for several days. The May 2006 event alone caused the following significant impacts:

- The City's main fire station and police department were isolated by floodwaters for several days. FEMA estimated the cost of this impact at \$1.4 million.
- Emergency responses during the flooding cost the City approximately \$360,000.
- FEMA estimated the loss of associated with road closures, delays, and detours cost \$4.2 million.
- FEMA insurance claims were paid to home and business owners to a total of more than \$4.6 million.

The City also experienced significant flooding in March 2010, October 2011 and December 2014 from short duration and intense rain events.

Flooding in the project area is largely due to high flows in the North River Canal caused by precipitation in the upgradient watersheds of Procter Brook and the North River (Metcalf & Eddy-AECOM, 2008). Precipitation events are projected to be more extreme due to climate change, which would exacerbate riverine flooding in the project area. Currently tidal influences at Mean Higher High Water (MHHW) extend approximately 230 feet upstream of Howley Street (Metcalf & Eddy-AECOM, 2008). Sea level rise is expected to extend tidal influences further upstream into the project area.

The flood events negatively impact area businesses and make it difficult for Fire and Police Department staff to respond to emergencies.



### 3.0 SUBSURFACE INVESTIGATION ACTIVITIES

Weston & Sampson explored subsurface conditions in the project area by overseeing the advancement of six (6) borings (B-1 through B-6) and six (6) test pits (TP-1 through TP-6) between November 5 and 9, 2018. The borings extended to depths of up to 22 feet below grade. The test pit excavations were terminated due to groundwater seepage at depths ranging from 5.6 to 6.8 feet. The approximate exploration locations are shown on Figure 2.

New England Boring Contractors (NEBC) of Derry, New Hampshire advanced the borings using an ATV or truck-mounted drill rig and drive and wash drilling methods. Standard penetration tests (SPTs) were conducted at 2-foot to 5-foot intervals using a standard 24-inch long by 1-3/8-inch inside diameter (2-inch outside diameter) split spoon sampler driven by blows from a 140-pound safety hammer falling 30 inches. Following completion of drilling, the borings were backfilled with soil cuttings.

NEBC excavated the test pits along the back of the existing canal wall using a Kubota U17 excavator with a toothed bucket. The test pits were backfilled with the excavated soil upon completion.

Weston & Sampson geotechnical engineering staff monitored drilling and test pit activities in the field and prepared logs for each boring. A Weston & Sampson structural engineer was also onsite to observe the structural characteristics of the back of the canal wall during test pit activities. Weston & Sampson environmental staff was on site to collect the representative soil samples for disposal characterization data to support the potential excavation and off-site disposal of soil associated with future repairs to the canal wall and construction of the Riverwalk. Boring and test pit logs from the 2018 explorations are included in Appendix D.

A description of the subsurface conditions based on the 2002 borings by GSI and the 2007 and 2018 borings by Weston & Sampson is provided below. Refer to Table 2 – Summary of Subsurface Conditions for a summary of the explorations. The conditions of the existing canal wall observed in the test pits are also summarized in Table 2.

#### 3.1 Subsurface Conditions

Subsurface conditions encountered in the explorations generally consisted of FILL overlying native SAND and SILT to the depths explored. ORGANIC SOILS were observed below the fill in six of the sixteen borings. The major soil groups encountered are described below, in general order of their occurrence with depth. Descriptions of the soils encountered are also included in the attached exploration logs. Variations may occur and should be expected outside of the exploration locations.

Fill: Very loose to very dense FILL (or probable fill) was encountered below surface materials (i.e. topsoil, bare earth, asphalt concrete pavement, or concrete) in all explorations except WS-3. The fill extended to depths ranging from about 4 to 15 feet, and generally consisted of fine to coarse sand with varying amounts of silt, gravel, organic matter, and debris including brick, glass, wood, asphalt, metal, and weathered mortar. Cobbles and boulders up to 28 inches in diameter were observed within the fill in test pits TP-2, TP-3, TP-5, and TP-6. Each of the test pits terminated within the fill.

Native soils: Loose to medium dense or very soft to medium stiff ORGANIC SOILS was encountered below the fill in borings B-1, B-3 through B-6, and WS-2. The organic soils extended to depths ranging from about 8 to 14 feet below existing grade.

Native SAND was encountered below the surface materials, fill, or organic soils in all borings. The sand was fine to coarse-grained or fine-grained, and contained varying amounts of silt and gravel. The sand

was generally described as medium dense to dense, except in borings advanced at 13 Wallis Street, where most of the sand samples were described as loose to medium dense. Roller bit grinding was noted within the sand in some borings, which may be indicative of the presence of cobbles and/or boulders. Medium stiff to hard SILT was encountered below or interlayered with the sand in borings WS-2, WS-3, WS-4, B-3, and B-5. Each of the borings terminated within the sand or silt.

*Refusal:* Borings B-1(GSI) and B-4(GSI) encountered auger refusal at depths of 40 feet and 32 feet, respectively. Rock coring was not performed, and therefore refusal could have been on cobbles, boulders, and bedrock.

### 3.2 Groundwater

Logs for borings B-1(GSI) through B-6(GSI) report groundwater depths ranging from 8 feet to 10.5 feet at the completion of drilling. Groundwater depths were not measured in borings WS-1 through WS-4 or B-1 through B-6 due to the drilling method (drive and wash) which introduces water into the borehole during drilling. Groundwater seepage was observed at depths ranging from about 4.6 to 6.7 feet below grade in TP-1 through TP-6. Groundwater levels are expected to be influenced by the water level in the North River Canal and may fluctuate due to local and regional factors including, but not limited to, precipitation events, seasonal changes, and periods of wet or dry weather.

### 3.3 Geotechnical Laboratory Testing

Select soil samples from the 2018 explorations were submitted to GeoTesting Express of Acton, Massachusetts for grain size analysis to confirm field classification and estimate engineering properties. Geotechnical Laboratory analytical results are included on the boring logs and in a copy is provided in Appendix E.

### 3.4 Conditions of Existing Canal Wall

Overall site conditions remained relatively unchanged from the 2017 structural evaluation report that was completed by Weston & Sampson and provided in *Appendix A*, other than an increase in overgrown vegetation. It was also noted that the north wall was at a lower elevation than the south wall for about half the wall length.

The six (6) exploratory test pits described above (TP-1 through TP-6) were excavated in order to determine the condition of the wall behind the canal, and to determine if any footings or foundations belong to the wall. Three (3) test pits (TP-1 through TP-3) were completed on the 24 Caller Street property, and the remaining three (3) test pits (TP-4 through TP-6) were completed on the 21 Caller Street Property. Locations of test pits can be found in *Figure 2*

At the originally proposed location of TP-1, the wall was in poor condition and a communal decision was made between engineers and the excavator operator to move about 12 feet eastward to a location of more stable wall, so as not to collapse the wall into the river during excavation. Test pit TP-1 revealed a rock wall consisting of large boulders about 34 inches in thickness. The canal-side face of the wall segment showed grout between each boulder. However, no grouted surfaces were found at the back of the wall. No visible footings or foundation were discovered after 6 feet of excavation. The top of wall was 3 feet 4 inches above the river bed, with 4 inches of water above the river bed.

At test pit TP-2, a concrete wall exists in good condition. At the test pit location, the wall thickness changes from 21 inches to 17 inches at a 90-degree bend. No structural foundation was discovered after 5 feet of excavation, however large rocks of similar size as at test pit TP-1 were encountered in test



pit TP-2 at the base of the wall and visible from the canal-side face of the wall. The top of wall was 6 feet 8 inches above the river bed with 1 foot 8-inches of water above the river bed.

Test pit TP-3 was excavated at a concrete wall segment in good shape and 21 inches thick. No footing was encountered after roughly six feet of excavation. The top of wall was 6 feet 4 inches to the river bed, with 1 foot 1-inch of water above the river bed.

The wall at test pit TP-4 was a stone wall with mortar on the front face and the excavated rear face. The wall was 16 inches thick. No visible footing was found after 6 feet of excavation. A hard and irregular shaped surface was encountered by probing with a metal rod about a foot below the test pit. The top of wall was 6 feet 4 inches above the river bed with 4 inches of water above the river bed.

The wall at test pit TP-5 consisted of roughly 20-inch thick stacked rocks. No visible grout or mortar was encountered on either side of the wall. No footing was encountered after 6 feet of excavation. The top of wall was 6 feet above the river bed with 2 feet of water above the river bed.

No wall was encountered during excavation at test pit TP-6. Small rocks were visible along the sloped shore line, with larger rocks at and just above the water level.

### 3.5 Disposal Characterization Sampling and Analysis

To support the potential excavation and off-site disposal of soil associated with future repairs to the canal wall and construction of the Riverwalk, Weston & Sampson collected one (1) composite soil sample (TP-5) from 5 to 6 feet below ground surface (bgs) from the test pit advanced on the 21 Caller Street property on November 6, 2018. The owners of 166R Main Street and 24 Caller Street would not allow Weston & Sampson to collect samples for environmental analyses.

The sample from the 21 Caller Street property was submitted for disposal characterization parameters pursuant to the Massachusetts Department of Environmental Protection (DEP) Policy #COMM-97-001, *Reuse and Disposal of Contaminated Soil at Massachusetts Landfill*, including: total petroleum hydrocarbons (TPH); Resource Recovery Act (RCRA) 8 metals (arsenic, barium, cadmium, chromium, lead, mercury, selenium and silver); semi-volatile organic compounds (SVOCs); polychlorinated biphenyls (PCBs); pH; ignitability; specific conductivity; and reactivity. The sample was later analyzed for speciated chromium and Toxicity Characteristic Leaching Procedure (TCLP) metals analysis. A grab soil sample was submitted for laboratory analysis for volatile organic compounds (VOCs) from the test pit.

The results of the disposal characterization analyses are presented in **Table 3**. The results were compared to the COMM-97-001 requirements for reuse at Massachusetts lined and unlined landfills. As shown in **Table 3**, soil analytical results indicate concentrations do not exceed the RCS-1 thresholds or the COMM-97-001 Disposal/Reuse levels for In-State Lined and Unlined Landfills and were consistent with the analytical results for the soils collected in the 0-5 ft bgs interval in 2017. However, based on the history of the Site and the contaminant concentrations detected, surplus soils generated at 21 Caller Street as part of the Riverwalk project will likely be required to be managed and disposed of appropriately in accordance with the Massachusetts Contingency Plan (MCP).

A copy of the laboratory analytical report is included as **Appendix F**.

## 4.0 ENVIRONMENTAL CONSIDERATIONS AND RECOMMENDATIONS

The City is considering property acquisition or easements on private property as part of the repair / replacement options for the southern canal wall and construction of the Riverwalk. As the City is aware, there is known or suspected soil contamination along the proposed area of these activities that will need to be addressed. Most of the area was formerly a tannery and it has known or potential environmental impacts, including several previously identified Disposal Sites as defined by the MCP; 310 CMR 40.0000.

In 2017, in support of the City of Peabody's desire to construct the Riverwalk along the North River Corridor, limited subsurface investigations were performed as part of a multi-parcel limited environmental assessment on the 21 and 24 Caller Street, 18 and 20 Howley Street, and 13 Wallis Street properties. Each assessment evaluated the top 5 feet of soils in an approximate 10-foot wide strip of land abutting the south side of the North River in Peabody, Massachusetts. Copies of the 2017 Limited Subsurface Investigation Reports are included as Appendix C. Analysis of soil samples identified concentrations of metals (i.e. antimony, arsenic, barium, trivalent chromium, unspeciated chromium (hexavalent), lead, and zinc) and polycyclic aromatic hydrocarbons (PAHs) (i.e. benzo(a)anthracene, benzo(a)pyrene, benzo(b)fluoranthene, dibenz(a,h)anthracene and phenanthrene) above the applicable MCP RCS-1 thresholds and Method 1 S-1/GW-2 and S-1/GW-3 standards. Therefore, excess soils generated during construction activities associated with the construction of the wall will be required to be managed and disposed of appropriately in accordance with the MCP.

A summary of the estimated soil transportation and disposal cost estimates associated with each property evaluated as part of the wall alternative analysis is provided in Table 4 – Soil Transportation and Disposal Cost Estimate Summary. These cost estimates do not include any soils that may need to be removed from the properties associated with the future construction of the proposed Riverwalk, etc., as the preliminary design of the Riverwalk has not been completed at this time.

### 4.1 MCP Regulatory Considerations

#### 4.1.1 13 Wallis Street

The property located at 13 Wallis Street is not listed as Disposal Site by MassDEP; however, it has a long, industrial history primarily in tannery operations. Currently, a US Post Office occupies the northwestern corner of the property and the remainder of the property is used to store miscellaneous construction equipment.

A subsurface investigation conducted in 2009 indicated the presence of fill material containing arsenic, chromium, and lead at concentrations in excess of the MassDEP Reportable Concentrations (RCs) for S-1 soil (RCS-1) at a depth of 0-5 feet below ground surface. Several additional metals and PCBs were detected at concentrations below the applicable MassDEP RCS-1 thresholds in shallow soil. PAHs were detected below the RCS-1 thresholds in deeper soil (5-10 feet below ground surface); however, PAHs were not analyzed in the 0-5 foot depth interval. Data collected during the 2009 sampling event is insufficient in that only two (2) boring locations were investigated, and no shallow soil was analyzed for PAHs. The concentrations of arsenic, chromium, and lead detected during the 2009 subsurface investigation above the RCS-1 thresholds were not reported to the MassDEP by the property owner.

The contaminant concentrations reported during Weston & Sampson's limited subsurface investigation in 2017 indicated that:

- A reportable condition exists at the Site due to the presence of arsenic, chromium, lead, and PAHs at concentrations above the RCS-1;
- The City is not currently obligated to report the RCS-1 exceedances to MassDEP, however, If the City takes ownership of the Site, the City will be responsible for reporting the release to MassDEP within 120 days of the property transfer;
- In general, contaminants in the 0-2 feet bgs depth interval tend to be similar to the concentrations of contaminants in soils in the 2-5 ft bgs depth interval;
- Excavation will require soil management under the MCP;
- The contaminated media (soil) will require disposal at an appropriate facility and documentation by a Licensed Site Professional (LSP); and
- The soil did not fail the leachability test and does not require disposal at a RCRA facility.

Prior to the start of construction at the Site, the detected release of PAHs, lead, and arsenic (detected during a previous investigation) will require reporting to the MassDEP, and construction will require management under a Release Abatement Measure (RAM). During construction of the preferred wall alternative selected by the City, soils will likely be excavated and will be required to be disposed of at a licensed facility.

Based upon currently available information, soils from 13 Wallis Street meet the disposal requirements for in-state unlined and lined landfills. However, Weston & Sampson has assumed that because each wall repair option at 13 Wallis Street generates less than 500 cubic yards of soils, all soils will be managed similarly across all properties as the cost difference among in-state and out of state non-hazardous disposal facilities does not exceed the cost to manage the soils separately. Out-of-state (non-hazardous) soil transportation and disposal currently costs approximately \$65 / ton.

Potential MCP regulatory obligations to the City associated with the repair / replacement of the southern canal wall along the corridor at the 13 Wallis Street Property may include the following:

- MCP compliance costs for soil disturbance / construction activities ~ \$40,000
  - Release Abatement Measure Plan (RAM) Plan, including Health and Safety Plan (HASP & Soil Management Plan (SMP)
  - RAM Status Report
  - Method 3 Risk Assessment for Riverwalk Area
  - Permanent Solutions Statement PSS (assumes no AUL based on existing data)
  - RAM Completion Report
  - Soil Management & Bills of Lading (BOLs)
- Construction Administration, Coordination & Oversight ~ \$5,000 - \$10,000

Estimated TOTAL = ~ \$45,000 - \$50,000 (not including release notification to MassDEP, soil transportation and disposal, wall repair design plans, regulatory permitting, bids and specifications or construction costs).

#### 4.1.2 24 Caller Street

The property located at 24 Caller Street has a documented history of environmental releases and is regulated under the MCP. In 2000, 24 Caller Street [Release Tracking Number (RTN) 3-18180] was closed under the MCP with an Activity and Use Limitation (AUL) [i.e., an A-3 Response Action Outcome (RAO) and AUL].

The AUL is located on the northwestern portion of the parcel and is approximately 15,000 square feet of

the 42,776-square feet total parcel area. The AUL restricts any activity including, but not limited to excavation, which is likely to disturb contaminated soil located at 1 to 8 feet below grade. Residential use and any other use at which a child's presence is likely [i.e., an educational facility/school (with the exception of adult education), a daycare/nursery, a recreational facility (such as a park or athletic fields, etc.)] is also prohibited. The portion of the 24 Caller Street parcel that the City is interested in redeveloping into the Riverwalk is also within the AUL area.

No files are available on-line from MassDEP for RTN 3-18180. A copy of the RAO Statement for the 24 Caller Street property (RTN 3-18180), dated August 4, 2000, was provided by the City. The RAO report is incomplete and did not include relevant data tables, appendices and/or referenced historical reports. A file review was therefore completed at the MassDEP for RTN 3-18180 on December 8, 2016. Contaminants of concern include metals (lead / chromium / cadmium / arsenic), PAHs and VOCs, and to a lesser extent polychlorinated biphenyls (PCBs). In addition, the site file for RTN 3-18180 indicated that a historic 'landfill' was identified in the northeast portion of parcel.

Given that the property has continued to operate as a barrel reconditioner in the approximately 19 years since regulatory closure and the data gaps from the previous RAO, a Limited Subsurface Site Investigation was conducted by Weston & Sampson on behalf of the City to evaluate the quality of the surficial and near surficial soils. The investigation was confined to the area of the proposed Riverwalk only.

In summary, the data that was generated during the 2017 limited subsurface investigation completed by Weston & Sampson is generally consistent with the limited findings presented in the RAO report for RTN 3-18180. Based on the data collected, no new reportable conditions under the MCP were encountered. Because the Site is fenced with limited access, no Imminent Hazard (IH) condition was discovered. However, the concentrations indicate that:

- In general, contaminants in the 0-2 feet bgs depth interval tend to be greater than the concentrations of contaminants in soils in the 2-5 ft bgs depth interval;
- Excavation will require soil management under the MCP;
- The contaminated media (soil) will require disposal at an appropriate facility and documentation by a LSP; and
- The soil did not fail the leachability test and does not require disposal at a RCRA or hazardous waste disposal facility.

Future Site use for the property as a passive recreational facility will have a different exposure scenario than current site conditions, therefore a Method 3 Risk Characterization for the property will be needed to evaluate risks under the new conditions and with new (i.e., post-construction) exposure point concentrations. Specifically, recreational use (such as a park or athletic fields) and/or any other use at which a child's presence is likely, are currently prohibited at the Site, in accordance with the AUL.

In addition, any activity including, but not limited to, excavation which is likely to disturb contaminated soil located at 1 to 8 feet bgs associated with underground utility and/or construction work, without prior development and implementation of a Soil Management Plan (SMP) and a Health and Safety Plan (HASP) is also prohibited. The contaminated soil located at 1 to 8 feet below surface grade must remain at depth and may not be relocated, unless such activity is first evaluated by a Licensed Site Professional (LSP) who renders an Opinion which states that such activity poses no greater risk of harm to health, safety, public welfare, or the environment and ensures that a condition of No Significant Risk is maintained.

.....

In summary, to repair the wall located at 24 Caller Street and construct the Riverwalk, soils will likely be excavated, and will need to be properly managed and disposed of at a licensed facility. Based upon currently available information, soils from 24 Caller Street must be disposed of at an out of state non-hazardous disposal facilities. Out-of-state (non-hazardous) soil transportation and disposal costs are currently estimated at approximately \$65 / ton.

Following removal of impacted materials, soil sampling will be required to evaluate remaining conditions and associated risk under the MCP. A new risk characterization will be required for the property. A geotextile membrane barrier may also be required to separate impacted fill as part of the risk management strategy. A revised Activity and Use Limitation (AUL) will likely also be required to document and manage site risks.

Potential regulatory obligations to the City associated with the repair / replacement of the southern canal wall along the corridor at the 24 Caller Street Property may include the following:

- MCP compliance costs for soil disturbance / construction activities ~ \$55,000
  - RAM Plan, including HASP & SMP
  - RAM Status Report
  - Additional sampling to support new risk characterization
  - Method 3 Risk Assessment
  - Revised PSS and AUL (and associated land survey)
  - RAM Completion Report
  - Soil Management & Bills of Lading (BOLs)
- Construction Administration, Coordination & Oversight ~ \$5,000 - \$10,000

Estimated TOTAL = ~ \$60,000 - \$65,000 (not including soil transportation and disposal, wall repair design plans, regulatory permitting, bids and specifications or construction costs).

As the City is interested in purchasing the entire 24 Caller Street parcel, a comprehensive Phase I/II Environmental Site Assessment (ESA) is recommended prior to the City taking title to the property in order to: 1) address data gaps; 2) to support the proposed reuse and evaluate exposure risks under non-industrial/commercial use; 3) to provide liability protection to the City; and 4) to evaluate regulatory obligations and costs to proceed with redevelopment of the property as a passive recreational facility. As detailed above, the RAO report for RTN 3-18180 was incomplete and did not include copies of relevant data / tables, appendices and/or referenced previous reports. Based upon our review, several data gaps exist at the property based upon the lack of information provided in the RAO report as well as the lack of any recent data relevant to the existing conditions at parcel based upon the barrel reclamation operations that have continued to be conducted at property since 2000.

#### 4.1.3 21 Caller Street

The 21 Caller Street property has a documented history of releases to the environment and is regulated under the MCP. 21 Caller Street [Release Tracking Number (RTN) 3-0577] is closed with a Permanent Solution Statement with Conditions that includes an AUL, which restricts any activity or uses that involve the excavation, removal and/or disturbance of soils greater than 3 feet below grade. Additionally, the AUL prohibits the use of the property. The AUL is applicable to the entire parcel but there has been limited assessment in the area of interest to the City along the canal.

Contaminants of concern are metals (i.e., cadmium, chromium and lead); however limited concentrations of Polycyclic Aromatic Hydrocarbons (PAHs), Volatile Organic Compounds (VOCs)



and/or Extractable Petroleum Hydrocarbons (EPHs) which have historically been detected at the property. Historical fill containing ash, cinders, brick, buffing dust, and/or leather scraps was also historically observed at approximately 1-8 feet below ground surface (bgs) across the property.

The data collected in 2017 was generally consistent with the findings in the PSS report filed for the Site under RTN 3-0577:

- In general, contaminant concentrations are similar in the 0-1 and 2-5 feet depth intervals, with the exception of 2-5 feet bgs soils at SP-3, which contains elevated concentrations of arsenic and lead;
- Excavation will require soil management under the MCP; and
- Surplus soil will require disposal at an appropriate facility and documentation by a Licensed Site Professional (LSP).

The Method 3 Risk Characterization presented in the PSS for the Site includes exposure scenarios consistent with the City's planned future for the Riverwalk. Specifically, "use of the [Site] without limitation to pedestrian and/or vehicle traffic" is permitted under the AUL. Furthermore, given that the 2017 and newly collected data is consistent with the previous data and findings of the PSS, an updated Method 3 Risk Characterization for the proposed Riverwalk (i.e. easement) area will not likely be necessary. However, activities inconsistent with the AUL including "excavation, removal, and/or disturbance of subsurface soil greater than three (3) feet below ground surface" are likely to occur during wall repair and redevelopment and will require a Release Abatement Measure (RAM) Plan to be filed with MassDEP, along with a Soil Management Plan (SMP) and Health and Safety Plan (HASP). A new risk characterization will not likely be required for the Riverwalk area and redevelopment is unlikely to require a separate AUL or PSS.

In summary, in order to implement a wall repair alternative, soils will likely be excavated and require disposal at an appropriate facility. Based upon currently available disposal characterization data collected from the proposed Riverwalk area of the property in 2017 and 2018, soils concentrations were less than RCS-1 and Comm-97 criteria for in-state unlined and lined landfills. However, Weston & Sampson has assumed that because each wall repair option at 21 Caller Street generates significantly less than 500 cubic yards of soils, all soils will be managed similarly across all properties as the cost difference among in-state and out of state non-hazardous disposal facilities does not exceed the cost to manage the soils separately. Out-of-state (non-hazardous) soil transportation and disposal currently costs approximately \$65 / ton.

Potential regulatory obligations to the City associated with the repair / replacement of the southern canal wall along the corridor at the 21 Caller Street Property may include the following:

- MCP compliance costs for soil disturbance / construction activities ~ \$30,000
  - Release Abatement Measure Plan (RAM) Plan, including HASP & SMP
  - RAM Status Report
  - RAM Completion Report
  - Soil Management & Bills of Lading (BOLs)
- Construction Administration, Coordination & Oversight ~ \$5,000 - \$10,000

---

Estimated TOTAL = ~ \$35,000 - \$40,000 (not including soil transportation and disposal, wall repair design plans, regulatory permitting, bids and specifications or construction costs).

#### 4.1.4 18 Howley Street

The property located at 18 Howley Street has a documented history of environmental releases and is regulated under the MCP. 18 Howley Street, identified by MassDEP as RTN 3-0577, was closed under the MCP in 2013 with a B-2 Response Action Outcome (RAO) and Activity and Use Limitation (AUL) [i.e., a Permanent Solution Statement with Conditions].

The AUL restricts the use of the property as a residence, school, daycare, nursery recreational area (e.g., park or athletic field) and/or any other use in which a child's presence (other than incidental). The AUL also restricts the use of the property for growing produce for human consumption as well as any long-term (greater than 1 month) activity at the property that is likely to result in the excavation, relocation and/or removal of soils, unless such activity is first evaluated by an LSP. The AUL is applicable to the entire parcel, and therefore includes the Site.

The primary contaminants of concern are metals (i.e., arsenic, chromium and lead), PAHs, extractable petroleum hydrocarbons (EPHs), dioxins, and polychlorinated biphenyls (PCBs). Historical fill containing ash and/or coal has also been observed. Contamination appears to be limited to the top 8 feet of soil across the property.

The data collected by Weston & Sampson during the limited subsurface investigations in 2017 is generally consistent with the limited findings in the RAO report for RTN 3-0577. Based on the data collected, no new reportable conditions under the MCP were encountered. Concentrations indicate that:

- In general, contaminants in the 0-1 feet bgs depth interval tend to be greater than the concentrations of contaminants in soils in the 2-5 ft bgs depth interval;
- Excavation will require soil management under the MCP;
- The contaminated media (soil) will require disposal at an appropriate facility and documentation by an LSP; and
- The soil did not fail the leachability test and does not require disposal at a RCRA (hazardous waste) facility.

Future Site use for the Riverwalk trail will have a different exposure scenario than current site conditions; therefore, a Method 3 Risk Characterization for the proposed Riverwalk (i.e. easement) area will need to evaluate risks under the new conditions and with new (i.e., post-construction) exposure point concentrations. Specifically, recreational use (such as a park or athletic fields) and/or any other use at which a child's presence is likely, are currently prohibited at the Site, in accordance with the AUL. Likewise, any long-term (greater than 1 month) activity at the property that is likely to result in the excavation, relocation and/or removal of soils, unless such activity is first evaluated by an LSP.

In summary, during construction of the preferred wall alternative, soils will likely be excavated and disposed of at a licensed facility. Based upon currently available information, soils from 18 Howley Street must be disposed of at an out of state non-hazardous disposal facilities. Out-of-state (non-hazardous) soil transportation and disposal costs are currently estimated at approximately \$65 / ton.

Following removal of impacted fill, soil sampling will be required to evaluate remaining conditions and associated risk. A new risk characterization will be required for the Riverwalk area. A geotextile membrane barrier may also be required to separate impacted fill as part of the risk management strategy. A separate AUL may also be required to document and manage site risks along the Riverwalk corridor area.

Potential regulatory obligations to the City associated with the repair / replacement of the southern canal wall along the corridor at the 18 Howley Street Property may include the following:

- MCP compliance costs for soil disturbance / construction activities ~ \$55,000
  - Release Abatement Measure Plan (RAM) Plan, including HASP & SMP
  - RAM Status Report
  - Additional sampling to support new risk characterization
  - Method 3 Risk Assessment for Riverwalk Area
  - Revised PSS and AUL for Riverwalk Area (and associated land survey)
  - RAM Completion Report
  - Soil Management & Bills of Lading (BOLs)
- Construction Administration, Coordination & Oversight ~ \$5,000 - \$10,000

Estimated TOTAL = ~ \$60,000 - \$65,000 (not including soil transportation and disposal, wall repair design plans, regulatory permitting, bids and specifications or construction costs).

#### 4.1.5 166R Main Street

The property located at 166R Main Street has a documented history of environmental releases and is regulated under the MCP. 166R Main Street, identified by MassDEP as RTN 3-1444 and RTN 3-4322.

RTN 3-4322 was closed under the MCP in 1997 with a A-2 RAO [i.e., a Permanent Solution Statement].

RTN 3-1444 was closed under the MCP in 2007 with an A-3 RAO and AUL [i.e. a Permanent Solution Statement with Conditions]. The AUL restricts the use of the property for single family residential use or for growing of produce for human consumption. The AUL also restricts activity at the property that is likely to cause physical or chemical deterioration, breakage, or damage to the pavement or building foundations, unless such activity is first evaluated by an LSP. The AUL is applicable to the entire parcel. The primary contaminants of concern at the 166R Main Street property are metals (i.e., arsenic, chromium and lead), PAHs, EPH, and VHP. Historical fill has also been observed in the top 8 to 10 feet of soil.

The property owner did not provide the City access to allow Weston & Sampson to collect samples for disposal characterization from the area of the proposed wall improvement activities and proposed Riverwalk. Therefore, for cost-estimation purposes, based upon the limited historical data available for the property and the data collected to date from the adjacent properties in the area, it has been assumed that soils generated during construction of the preferred wall alternative at 166R Main Street will be required to be disposed of at an out of state non-hazardous disposal facilities. Out-of-state (non-hazardous) soil transportation and disposal costs are currently estimated at approximately \$65 / ton.

Future use for the Riverwalk trail will have a different exposure scenario than current site conditions; therefore, a Method 3 Risk Characterization for the proposed Riverwalk (i.e. easement) area will need to evaluate risks under the new conditions and with new (i.e., post-construction) exposure point concentrations.

A geotextile membrane barrier may also be required to separate impacted fill as part of the risk management strategy. A separate AUL may also be required to document and manage site risks along the Riverwalk corridor area.



Potential regulatory obligations to the City associated with the repair / replacement of the southern canal wall along the corridor at the 166R Main Street Property may include the following:

- MCP compliance costs for soil disturbance / construction activities ~ \$55,000
  - Release Abatement Measure Plan (RAM) Plan, including HASP & SMP
  - RAM Status Report
  - Additional sampling to support new risk characterization
  - Method 3 Risk Assessment for Riverwalk Area
  - Revised PSS and AUL for Riverwalk Area (and associated land survey)
  - RAM Completion Report
  - Soil Management & Bills of Lading (BOLs)
- Construction Administration, Coordination & Oversight ~ \$5,000 - \$10,000

---

Estimated TOTAL = ~ \$60,000 - \$65,000 (not including soil transportation and disposal, wall repair design plans, regulatory permitting, bids and specifications or construction costs).

#### 4.2 MCP Environmental Regulatory Summary and Recommendations

The properties that will be impacted as part of the repair / replacement alternatives for the south wall of the North River Canal are known or suspected to be contaminated. Construction activities will require management of soils in accordance with the MCP and under a RAM Plan. Excess soils will be required to be disposed of at a licensed disposal facility. Given the approximate quantities to be generated at each individual property locations for the repairs of the wall, Weston & Sampson has assumed that all soils will be managed similarly across all properties as the cost difference among in-state and out of state non-hazardous disposal facilities does not exceed the cost to manage the soils separately.

Additional MCP regulatory compliance requirements may also include: RAM Status Reports, additional sampling to support new risk characterization for Riverwalk area, Method 3 Risk Assessments for Riverwalk Area; Revised PSSs and AULs for Riverwalk Area (and associated land surveys); RAM Completion Reports, Soil Management & Bills of Lading (BOLs); and Construction Administration, Coordination & Oversight. In total, MCP regulatory compliance requirements are currently estimated at approximately \$260,000 - \$285,000. Cost do not include out-of-state (non-hazardous) transportation and disposal cost for soils that need to be removed as part of the repairs to the wall, as these costs have been included in the wall alternative cost estimates provided in *Appendix I*.

## 5.0 GEOTECHNICAL DESIGN AND CONSTRUCTION RECOMMENDATIONS

The following sections provide preliminary geotechnical design considerations and recommendations for site design, and for evaluation and selection of preferred wall replacement alternative(s). Weston & Sampson should be contacted to provide specific geotechnical design and construction recommendations during final design. Additional information on the use of these geotechnical recommendations is provided in the document titled "Important Information about this Geotechnical Engineering Report" by Geoprofessional Business Association (GBA), Inc., included as Appendix G.

### 5.1 Existing Fill and Organics

Undocumented fill and organic soils were encountered to depths of up to 15 feet below grade, with organic soil thicknesses ranging from 1.5 to 8 ft. at locations explored. These materials are not suitable for support of structures due to the risk of differential settlement from variable rates of compression/decomposition of these materials. Fill and organics should be removed from within the "zone-of-influence" (ZOI) beneath new foundations and other rigid structures sensitive to settlement. The ZOI is defined by planes extending horizontally away from the bottom edge of the structure a distance of two feet, then down and away at a 1H:1V (horizontal:vertical) slope to the intersection with suitable native soils. The resulting excavation should be backfilled with compacted Structural Fill.

Placement of new fill above existing site grades will result in settlement due to compression of underlying existing fill and organic soils. The amount of settlement will vary with the load increase and the thickness and composition of existing fill and organics. Over-excavation and replacement of the unsuitable materials, the use of lightweight fill materials, or design for settlement should be considered if grade changes are proposed.

### 5.2 Retaining Walls

Concrete cantilever walls or stone masonry walls can be supported on a minimum 12-inch thick bedding layer of compacted Structural Fill overlying native, inorganic sand and/or silt following removal of existing fill and organic soils. The retaining wall bedding layer should extend at least 18 inches horizontally past the edges of the wall foundation or bottom blocks. Foundations should extend at least 4 feet below the nearest ground surface exposed to freezing.

Retaining wall foundations bearing on subgrades prepared as described herein can be designed using an allowable bearing pressure of 2000 psf for foundations constructed on loose sands such as at 13 Wallis Street, and 4000 psf for foundations constructed on medium dense (or denser) sand or medium stiff (or stiffer) silt or structural fill.

#### 5.2.1 Lateral Pressures

Design lateral pressures should consider appropriate loading conditions including earth pressures, hydrostatic, wind, seismic, and surcharge loads such as sloped backfill, structures and adjacent traffic as appropriate. The design lateral pressures should be calculated by adding unbalanced earth and water pressures, and surcharge pressures from structures near the proposed wall.

Lateral earth pressures for design of new retaining walls may be computed using the preliminary soil parameters provided in the table below:

## Preliminary Soil Design Parameters for Retaining Walls

Parameter	Values for			
	Existing Fill	Organics	Native Sand and Silt	Compacted Backfill
Angle of Internal Friction, $\phi$	28°	26°	30°	34°
Total Unit Weight, $\gamma$ (pounds per cubic foot)	125	115	125	130
Buoyant Unit Weight, $\gamma'$ (pounds per cubic foot)	62.6	52.6	62.6	67.6

Groundwater level at the site should be assumed at ground surface. In addition, we recommend a minimum 150 psf lateral surcharge pressure be assumed over the full height of the wall, intended to account for vertical areal surcharge pressures at the top of the wall up to 300 psf. Additional lateral pressures equal to 0.5 times the additional surcharge pressures should be added to sections of wall where surcharge pressures exceed 300 psf.

Resistance to lateral loads should be calculated using a base friction coefficient of 0.35. For resistance to lateral loading we recommend a minimum factor of safety of 1.5 when using sliding friction alone. A larger magnitude of movement is required to engage passive resistance than sliding friction. Therefore, a minimum factor of safety of 2.0 is recommended when using passive pressure in addition to friction to resist lateral loads. Passive earth pressures should be ignored for a depth of 4 feet below bottom of canal.

Footings, floor slabs, and other improvements located above and behind retaining walls (including footings for upper walls in tiered retaining wall configurations) and within a zone defined by a plane extending upward at 1H:1V from the back of the bottom of the wall will increase lateral pressures on the wall. We should be consulted if footings or surcharges are located within this zone. The global slope stability of the proposed retaining walls will have to be confirmed once design progresses.

### 5.2.2 Seismic Considerations

Seismic site class is determined in accordance with the International Building Code (IBC) as adapted by the Massachusetts State Building Code using a weighted average of SPT blow counts in the upper 100 feet of soil at a site. Based on the soil types and consistencies encountered in the boring (to the depths explored), we recommend that new canal walls be designed using parameters presented in the table below:

Seismic Design Parameters

Design Parameter	Recommended Value
Site Class	E
$S_s$	0.240 g
$S_1$	0.073 g
$F_a$ [IBC Table 1613.5.3(1)]	2.5
$F_v$ [IBC Table 1613.5.3(2)]	3.5

Loose, potentially liquefiable native sands were encountered in borings WS-1, B-1(GSI) through B-3(GSI), B-5(GSI) and B-6(GSI) at 13 Wallis Street. Soil liquefaction describes a phenomenon in which saturated granular soils lose their strength during earthquake conditions, causing sinkholes, or deformation and/or settlement of structures they support. Liquefaction potential depends on the soil density, fines content, groundwater depth, and the magnitude of ground movements during seismic events. Additional borings and lab testing should be conducted in this area during final design to further evaluate the potential for liquefaction. Mitigation measures such as over-excavation and replacement may be necessary to address potential liquefaction.

### 5.3 Construction Considerations

Existing structures, pavements, curbing, vegetation, topsoil, tree roots greater than 1-inch in diameter, and surface debris should be removed from within the limits of construction during initial site preparation. The existing fill contains debris, cobbles, and boulders which may interfere with installation of driven wall elements. Pre-trenching may be required to remove these obstructions if a driven wall type is selected (such as soldier pile or sheet pile wall). Any existing utilities within the proposed development areas should be identified and properly removed, re-routed, or evaluated and approved to remain.

Excavations to remove and replace the existing canal walls will extend up to about 10 feet, or deeper where unsuitable soils are present at proposed structure bearing depths. Temporary excavation support will be required where excavations cannot feasibly be open cut, such as locations adjacent to structures and utilities, and where groundwater seepage is present. Groundwater is expected to be approximately equal with the water level in the canal and dewatering of excavations should be anticipated during construction.

Weston & Sampson should be contacted to evaluate exposed subgrades prior to placement of overlying materials and foundation construction.

#### 5.3.1 Fill Materials and Placement

The existing fill at the site contains variable amounts of fines, organics, and debris. The existing fill is not suitable for use as Structural Fill (i.e., support of structures or other settlement sensitive features) but may be suitable for use as backfill in non-structural or landscape areas, provided it can be moisture conditioned and compacted to at least 92 percent maximum dry density as determined by ASTM D1557 (modified proctor).

Structural Fill beneath foundations and other settlement sensitive improvements (or where on-site materials are not available or suitable for re-use) should consist of well graded imported sand and gravel with less than approximately 10 percent fines (such as MassDOT M1.03.0- type B Gravel Borrow or M2.01.7 Dense-graded Crushed Stone). Structural fill should have a maximum particle size of 3 inches and be compacted to at least 95 percent of maximum dry density as determined by ASTM D1557.

Crushed stone shall be wrapped in filter fabric, consisting of a woven geosynthetic with an AOS of #70 to #100 sieve, and a minimum puncture resistance of at least 120 pounds (such as Mirafi FW700 or equivalent).

## 6.0 WALL ALTERNATIVE ANALYSIS

Five wall alternatives are being considered for the repair of the south wall of the North River Canal from Wallis Street to Howley Street. The alternative wall types being considered are:

- Alternative A – Rip Rap Slope
- Alternative B – Vegetative Berm Above Rip Rap Slope
- Alternative C – Sheet Pile Wall
- Alternative D – Cantilever Concrete Retaining Wall
- Alternative E – Stone Masonry Wall

Regardless of the alternative chosen, grades along the river may need to be raised or lowered in order to achieve ADA compliance for the Riverwalk. A new bridge structure will likely be required over Strongwater Brook. The existing Caller Street Bridge creates a design constraint for all alternatives considered. Each alternative has taken into account the need to accommodate the existing river width opening at the Caller Street Bridge. Each alternative will require the handling of contaminated/potentially-contaminated soils to some extent. Easements or property acquisition will be required for each alternative to accommodate the Riverwalk, with some alternatives requiring more property than others. Multiple storm drains exist in the area of the proposed new wall alternatives; these drains will need to be accommodated and accounted for later in the design process. Typical cross sections of each alternative can be seen in *Appendix H*.

Since the north wall is at a lower height elevation than the current south wall for about half of the river length being considered, raising the south wall height would create more flooding on the north side of the river. If additional flood storage is desired, each alternative can be adjusted to allow for river widening in addition to repairing the south wall. All design alternatives propose the new south wall height be constructed to match the existing south wall height.

Each alternative was analyzed for its resilience, durability, environmental impacts, constructability, construction schedule, and cost. The recommended alternative was decided by comparing these five aspects of each design alternative. The engineer's cost estimate for each alternative can be found in *Appendix I*.

The resiliency of each wall alternative was evaluated based on the six design flood-climate change projection scenarios presented in Weston & Sampson's report entitled, *MVP Action Grant: Peabody North River Canal Resilient Wall, Riverwalk and Park – Resilience Evaluation (Resilience Evaluation)*, dated February 2019, and the estimate of the potential benefit in terms of volume of storage and the number of parcels that may be removed from the floodplain without increasing downstream flooding impacts. Fifty-eight parcels or portions of parcels were identified in the study area. The maximum percent of parcels protected for all wall alternatives and the six scenarios ranged from 11% to 60% of the total number of parcels in the study area. A copy of the Resilience Evaluation is provided in Appendix J.

### 6.1 Alternative A – Rip Rap Slope

Alternative A consists of placed rip rap on a slope of 1 vertical to 1.5 horizontal. The rip rap will be placed in a 3-foot thick layer, with diameters ranging from 8 to 24-inches, underlain with a 1-foot layer of bedding stone placed on top of geotextile fabric for permanent erosion control. The rip rap will extend 5-feet into the river bed and 3.5-feet below the river bed to maintain continuity with the slope. This alternative requires the removal of the existing south wall along the entire length in consideration.

Two options are considered for the location of the bottom of the rip rap slope. Option 1 is to set the bottom of the slope at the location of the existing wall which will provide some additional flood storage. Option 2 is to set the bottom of the slope into the river providing no additional flood storage but maintaining the storage the current river width provides.

#### 6.1.1 *Resilience*

- Option 1 would provide 18 cu. ft./ft. additional flood storage capacity; Option 2 would match current flood storage capacity.
- The surface roughness of the rip rap would decrease flood flow speed.
- Allows flexibility to vary slope along river length to allow more flood storage at key locations.
- In the future, both options can accommodate the future flood elevations by constructing a berm on top of the would-be existing slope, however the north wall height will also need to be increased to not cause increased flooding on the north side. The Riverwalk pathway would need to be located away from the top of slope to allow room for this potential future berm to be constructed. Additional easement area or land acquisition would be required.
- Neither option requires compensatory storage for regulatory purposes since they both provide a greater than or equal amount of flood storage as existing conditions allow. If more flood storage is desired by the City then the land at 24 Caller Street can potentially be regraded to provide additional flood storage space.

#### 6.1.2 *Durability*

- This alternative requires inspections to be performed after flood events and a minimum level of maintenance such as replacing any dislodged rocks after a flood event and managing vegetation to prevent overgrowth.
- With proper maintenance and routine inspection, a rip rap slope should provide a minimum life span of 50 years.

#### 6.1.3 *Environmental Impact*

- Requires excavation of contaminated soils to form the rip rap slope.
- Requires dredging of the streambed to construct the toe of the rip rap slope.
- Stones in the existing channel wall can be incorporated into the riprap slope.

#### 6.1.4 *Constructability & Construction Schedule*

- This alternative is easy to construct and does not require any special equipment or methods.
- Water control will be necessary to construct the rip rap slope.
- Requires excavation of abandoned rail road east of Strongwater Brook.
- Requires demolition of the abandoned building foundation east of Strongwater Brook.
- Estimated construction duration is 5 months.

#### 6.1.5 *Right-of-Way*

- This alternative will require a maximum permanent easement that is approximately 25 feet wide from the face of the existing wall.
- A 15-foot-wide temporary easement for construction will be required as well.

### 6.2 **Alternative B – Vegetative Berm Above Rip Rap Slope**

Alternative B is similar to Alternative A except the rip rap slope for this alternative will stop at



approximately 3.5-feet above the river bed with the vegetative berm extending to the top of the slope. The slope of the vegetative berm would be 1 vertical to 3 horizontal. This alternative requires the removal of the existing south wall along the entire length in consideration.

Alternative B, like Alternative A, has the same two options for the location of the bottom of slope.

#### 6.2.1 *Resilience*

- Option 1 would provide 20 cu. ft./ft. additional flood storage capacity; Option 2 would match current flood storage capacity.
- The surface roughness of the rip rap and vegetative slope would decrease flood flow speed.
- Allows flexibility to vary slope along river length to allow more flood storage at key locations.
- In the future, both options can accommodate the future flood elevations by constructing a berm on top of the would-be existing slope, however the north wall height will also need to be increased to not cause increased flooding on the north side. The Riverwalk pathway would need to be located away from the top of slope to allow room for this potential future berm to be constructed. Additional easement area or land acquisition would be required.
- Neither option requires compensatory storage for regulatory purposes since they both provide a greater than or equal amount of flood storage as existing conditions allow. If more flood storage is desired by City, then the land at 24 Caller Street can potentially be regraded to provide additional flood storage space.

#### 6.2.2 *Durability*

- This alternative requires inspections to be performed after flood events and a minimum level of maintenance such as replacing any dislodged rocks after a flood event and managing vegetation to prevent overgrowth.
- With proper maintenance and routine inspection, a rip rap and vegetative slope should provide a minimum life span of 50 years.

#### 6.2.3 *Environmental Impact*

- Requires excavation of contaminated soils to form the rip rap slope.
- Requires dredging of the streambed to construct the toe of the rip rap slope.
- Stones in the existing channel wall can be incorporated into the riprap slope.

#### 6.2.4 *Constructability & Construction Schedule*

- This alternative is easy to construct and does not require any special equipment or methods.
- Water control will be necessary to construct the rip rap and vegetative slope.
- Requires excavation of abandoned rail road east of Strongwater Brook.
- Requires demolition of the abandoned building foundation east of Strongwater Brook.
- Estimated construction duration is 5 months, which does not include growing season of the vegetation.

#### 6.2.5 *Right-of-Way*

- This alternative will require a maximum permanent easement that is approximately 28 feet wide from the face of the existing wall.
- A 15-foot-wide temporary easement for construction will be required as well.

### 6.3 Alternative C – Sheet Pile Wall

Alternative C Option 1 consists of a sheet pile wall installed behind the existing wall to an approximate depth of 20 feet below the top of slope. The existing wall structure would be removed after the sheet piles are installed, providing a small increase in flood storage. A concrete cap would be constructed along the top of the sheet pile wall for a more aesthetic look and to cover the jagged top of the sheet piling. An available option for this alternative is architectural cladding, such as a stone veneer matching the aesthetics of the existing wall.

Alternative C Option 2 consists of a sheet pile wall installed behind the existing wall. The sheet pile would extend 2-feet above the canal bed, and 13-feet below ground. A sloped bank, of either rip rap or vegetative berm, would then extend from the top of the sheet pile to the top of bank. A rip rap slope would require more excavation of soils than the vegetative berm option but would be more stable during flood events. The vegetative berm would require less excavation than a rip rap slope but would be less stable during and after flood events. Both the rip rap slope and vegetative berm options would provide additional flood storage.

#### 6.3.1 Resilience

- Option 1 would increase flood storage by adding approximately 8.5 cu.ft./ft. of additional flood storage due to the removal of the existing stone masonry wall which increases the cross section of the channel.
- Option 2 would provide an additional 20-25 cu.ft./ft. additional flood storage due to the rip rap slope or vegetative berm.
- Height of wall can be increased in the future; however, the north wall height will also need to be increased to not cause increased flooding on the north side. Requires design and special detailing of the wall to accommodate future height addition (cost included in engineer's cost estimate).
- This option does not require compensatory storage for regulatory purposes since it provides greater storage capacity than currently available. If more flood storage is desired by City, then the land at 24 Caller Street can potentially be regraded to provide additional flood storage space.

#### 6.3.2 Durability

- Steel sheet piling requires very minimal maintenance, such as monitoring for deviation from design alignment and corrosion. The concrete coping would need to be checked for minor cracks and spalls at multiple times during its design life.
- Steel sheet piling can provide a minimum design life of 75 years.
- Rip rap requires inspections to be performed after flood events and a minimum level of maintenance such as replacing any dislodged rocks after a flood event. The vegetative berm would be less stable than the rip rap during and after flood events. The vegetative berm would also require scheduled maintenance of vegetation to prevent overgrowth.
- With proper maintenance and routine inspection, a rip rap slope should provide a minimum life span of 50 years.

#### 6.3.3 Environmental Impact

- Sheet pile installation will create more noise than the other alternatives. This may be able to be mitigated based on the installation methods needed.
- Option 1 requires the least amount of contaminated soil removal of all Alternatives considered.
- Option 2 requires no dredging of the stream bed.



#### 6.3.4 *Constructability & Construction Schedule*

- This alternative will require specialized equipment for the installation of the sheet piling.
- Water control will be necessary for the removal of the existing stone masonry wall.
- Requires excavation of abandoned rail road east of Strongwater Brook.
- Minimizes the demolition of the abandoned building foundation east of Strongwater Brook for Option 1.
- Estimated construction duration is 4-5 months

#### 6.3.5 *Right-of-Way*

- This alternative will require permanent easement that is approximately 15 feet wide from the face of the existing wall for Option 1 and up to 30 feet wide for Option 2.
- A 15-foot-wide temporary easement for construction will be required as well.

### 6.4 **Alternative D – Cantilever Concrete Retaining Wall**

Alternative D consists of removing the existing stone masonry wall and constructing a concrete cantilever retaining wall in the same location. The concrete retaining wall will have a footing constructed approximately 4 feet below the stream bed. The stem of the concrete wall will be approximately 14 inches wide at the top and about 30 inches wide at the base. A concrete form liner may be used to provide texture or the look of a stone veneer if desired.

#### 6.4.1 *Resilience*

- This alternative would not provide any increase in flood storage.
- Height of wall can be increased in the future; however, the north wall height will also need to be increased to not cause increased flooding on the north side. Requires design and special detailing of the wall to accommodate future height addition (cost included in engineer's cost estimate).
- This option does not require compensatory storage for regulatory purposes since it provides equal storage capacity as currently available. If more flood storage is desired by City, then the land at 24 Caller Street can potentially be regraded to provide additional flood storage space.

#### 6.4.2 *Durability*

- Requires minimal maintenance including minor spall or crack repairs; repairs will need to be completed multiple times during its design life.
- A concrete retaining wall, with proper maintenance, can provide a minimum design life of 75 years.

#### 6.4.3 *Environmental Impact*

- Requires excavation of contaminated soils.
- Requires dredging of the streambed to construct the footing.
- Requires over-excavation of organic soils to prevent settlement.

#### 6.4.4 *Constructability & Construction Schedule*

- This alternative does not require any specialized equipment or methods.
- Water control will be necessary for the removal of the existing stone masonry wall and construction of the new wall.
- Sheet piling should be permanently installed at the toe of the footing in areas of deep organic soils, such as at 24 Caller St and 166R Main St.

- Requires excavation of abandoned rail road east of Strongwater Brook.
- Requires demolition of the abandoned building foundation east of Strongwater Brook.
- Estimated construction duration is 6-8 months.

#### 6.4.5 *Right-of-Way*

- This alternative will require permanent easement that is approximately 15 feet wide from the face of the existing wall.
- A 15-foot-wide temporary easement for construction will be required as well.

### 6.5 **Alternative E – Stone Masonry Wall**

Alternative E consists of removing the existing stone masonry wall and constructing a new stone masonry wall on a concrete footing in the same location. The stem of the wall will be approximately 20 inches wide at the top and 4 feet at the base. The concrete footing would be constructed approximately 4 feet below the stream bed. This alternative would provide no additional flood storage space.

#### 6.5.1 *Resilience*

- This alternative would not provide any increase in flood storage.
- Height of wall can be increased in the future; however, the north wall height will also need to be increased to not cause increased flooding on the north side. Requires design and special detailing of the wall to accommodate future height addition (cost included in engineer's cost estimate).
- This option does not require compensatory storage for regulatory purposes since it provides greater storage capacity than currently available. If more flood storage is desired by the City then the land at 24 Caller Street can potentially be regraded to provide additional flood storage space.

#### 6.5.2 *Durability*

- The stone masonry retaining wall requires a moderate amount of maintenance such as repointing of masonry. The majority of maintenance will be required above the waterline; however, some areas may require maintenance and repair below the water level. Maintenance done below water level will require sandbags to divert water away from location of repairs.
- A stone masonry retaining wall, with proper maintenance, can provide a minimum design life of 50 years.

#### 6.5.3 *Environmental Impact*

- Requires excavation of contaminated soils.
- Requires dredging of the streambed to construct the footing.
- Requires over-excavation of organic soils to prevent settlement.

#### 6.5.4 *Constructability & Construction Schedule*

- This alternative does not require any specialized equipment or methods.
- Water control will be necessary for the removal of the existing stone masonry wall and construction of the new wall.
- Sheet piling should be permanently installed at the toe of the footing in areas of deep organic soils, such as at 24 Caller St and 166R Main St.
- Requires excavation of abandoned rail road east of Strongwater Brook.
- Requires demolition of the abandoned building foundation east of Strongwater Brook.
- Estimated construction duration is 7-9 months.

#### 6.5.5 *Right-of-Way*

- This alternative will require permanent easement that is approximately 15 feet wide from the face of the existing wall.
- A 15-foot-wide temporary easement for construction will be required as well.

## 7.0 REFERENCES INCREMENTAL APPROACH

Climate change projections indicate that, by 2100, mean sea level rise in Boston Harbor since 2000 is unlikely to exceed (83% probability) 4.0 feet although it could be as high as 10.2 feet (NECSC). Boston Harbor has seen a sea level rise of more than 11 inches between 1921 and 2018. Since the North River Canal is tidally influenced closer to Salem, it is possible the canal will experience an even higher likelihood of extreme flooding as the canal shoulder of the North River will likely become tidal. Since work is only being done to the south wall, a significant decrease in current riverine flooding is difficult without also working on the north wall. There are options and steps that can be taken to assure that the south wall of the North River Canal can be altered to accommodate larger flood events or to match future work done of the north wall.

Not all alternative options will be able to accommodate an added wall height in the future. The rip rap slope, vegetative berm and sheet pile walls could be altered to accommodate an increase wall height but may require additional land usage to do so. The stone masonry wall and concrete cantilever wall could be designed to accommodate future wall height increase. For it to be possible to increase the wall height in the future, the walls will need to be designed to have additional capacity than current conditions require.

Raising the South wall height in the future would only provide additional flood storage if the North wall height were also increased. If the South wall were to be raised in the future without raising the North wall as well, it would only increase flooding on the North side of the canal.

Additional investigations would still be required in the future to ensure the wall has available capacity and no deterioration or damage has occurred that would reduce the capacity of the walls.

.....

## 8.0 PERMITTING STRATEGY

### 8.1 Introduction

Weston & Sampson has developed five (5) design repair / replacement alternatives, Alternative A through Alternative E. Alternatives A, B, and C each included two separate options (options 1 & 2) for the south canal wall in order to support the construction of a Riverwalk and improve the flood resilience along the North River Canal. Wall alternatives include options for repairing the wall in place to protect against future flooding as well as other options that provide additional flood storage. Weston & Sampson then conducted a preliminary analysis and evaluated the permitting strategy for each of the proposed five (5) wall alternatives.

The permitting evaluation which follows in this chapter, first reviews each alternative for the amount of impact to resource areas, the required environmental permits associated with those impacts, permitting timelines, and finally permitting costs. In addition, an evaluation of the different wall options and associated permitting was also conducted based on the anticipated ease or feasibility of implementation with regulatory agencies, and other additional studies or requirements, and their associated costs, that may be required as part of for each wall alternative.

The five (5) wall alternatives that are being considered for the repair of the south wall of the North River Canal are:

- Alternative A – Rip Rap Slope
  - Option 1, build out from Toe of existing wall
  - Option 2, build out from inside of existing wall
- Alternative B – Vegetative Berm Over Rip Rap Slope
  - Option 1, build out from Toe of existing wall
  - Option 2, build out from inside of existing wall
- Alternative C – Sheet Pile Wall
  - Option 1, Sheet Pile with Concrete Cap
  - Option 2, Sheet Pile with Sloped Bank (rip-rap or vegetated berm)
- Alternative D – Cantilever Concrete Retaining Wall
- Alternative E – Stone Masonry Wall

Currently, it is infeasible to modify the north wall of the river, so these alternatives are only relative to the south wall. Furthermore, since the north wall is at a lower elevation than the current south wall for about half of the river length, there would be no point to raise the wall height to accommodate future flood levels, as it would just force the flood water to the north. In order to obtain additional flood storage from these repairs the river would need to be widened.

There is known or suspected soil contamination along the proposed Riverwalk area that will also need to be addressed, as each alternative will require the handling of soils to some extent. The permitting strategy detailed in this chapter report does not include any MCP permitting associated with the contamination found. Easements or property acquisition will be required for each alternative to accommodate the Riverwalk, with some alternatives requiring more property than others.

A description of the typical permits and requirements that might be required for each alternative can be seen in **Appendix K**. **Appendix L** provides a summary table of estimated regulatory impacts and likely permits required for each of the five options, while **Appendix M** provides a permit approval schedule for

each alternative.

Information presented in the permitting matrix in Section 8.3 - Permitting Summary and Recommendations, is described in greater detail, below.

## 8.2 Environmental Permitting Strategy

### 8.2.1 *Alternative A – Rip Rap Slope*

A rip rap slope would require the removal of the existing south wall along the entire length in consideration. The rip rap would be placed with a slope of 1 vertical to 1.5 horizontal; the stone can be locally sourced or reused from the current south wall. The rip rap will extend 5-feet into the river bed and 3.5-feet below the river bed to maintain continuity with the slope. Two options are presented for the location of the slope.

- Option 1 will begin the 1:1.5 slope where the current wall exists, providing additional flood storage along the slope.
- Option 2 will begin the 1:1.5 slope roughly 3.5-feet north of the south wall (in the river) providing no additional flood storage but maintaining the storage the current river width provides.

#### 8.2.1.1 *Regulatory Impacts*

Environmental resources that will be impacted with both Rip Rap Slope options include the following (all calculations are estimates based on current conceptual designs):

- Bank of perennial stream
  - For both rip rap options, an estimated 1,335 linear feet (lf) will be impacted due to the removal of the existing wall.
- Land under water associated with a perennial stream
  - Option 1 will result in Land Under Water (LUW) impacts of 6,700 sf and dredging of 24,800 cubic feet (cf) of material.
  - Option 2 will result in LUW impacts of 12,300 sf, 43,500 cf of dredge, and unknown amount of fill.
- 100-year flood zone
  - Option 1 would increase flood storage by adding approximately 24,000 CF of additional flood storage due to the removal of the existing stone masonry wall Option 2 will match existing storage volume
- Riverfront area
  - Option 1 will impact 26,000 sf
  - Option 2 will impact 21,000 sf

#### 8.2.1.2 *Potential Permits*

Potential permits required for both the rip rap slope alternatives include the following:

- MA Wetlands Protection Act Notice of Intent
- MassDEP 401 Water Quality Certification
- MassDEP Chapter 91 submission
- MEPA Environmental Notification Form
- US Army Corps of Engineers Individual Permit

A description of these permits and typical required documents has been included in *Appendix K*.

#### 8.2.1.3 Permit Costs

Permit costs can vary depending on resource area impacts, project complexity, and reviewer comments. The typical range of costs per likely required permit is provided below.

#### Permit Costs for Rip Rap Slope Options 1 or 2

Permit	Minimum Cost	Maximum Cost
MassDEP Wetlands NOI	5,000	10,000
MassDEP 401 WQC	5,000	10,000
MassDEP Ch 91	5,000	10,000
MEPA ENF	5,000	10,000
ACOE IP	5,000	10,000
<b>TOTAL</b>	<b>25,000</b>	<b>50,000</b>

Option 2 would most likely incur an additional \$10,000 -15,000 for additional studies related to mitigation/compensation design.

#### 8.2.1.4 Permit Approval Schedule

To efficiently gain permit approvals, it is recommended that the ENF be submitted first. The ENF is forwarded to those reviewers who would have jurisdiction or an interest in the project. Comments from these reviewers are forwarded to the MEPA reviewer, who compiles the comments and forwards them on to the project proponent.

It is helpful to get these comments first and incorporate these comments into the remaining permit submissions to minimize the amount of back and forth with reviewers. Once submitted, the review time for the ENF is approximately 60 days. After incorporating the ENF comments into the remaining permits, all remaining permits can be submitted simultaneously. The ACOE IP can take up to 135 days before gaining approval. The joint 401 WQC / Chapter 91 submission can take from approximately 150 – 400 days for review, depending on if MassDEP determines there are administrative or technical deficiencies with the submission and requests additional information. Finally, assuming the NOI review requires two (2) public meetings, the review process can take approximately 45 days.

In all, the environmental permit review process could take between **seven (7) and fifteen (15) months**.

#### 8.2.1.5 Alternative Favorability

When evaluating both options from a favorability standpoint, Option 1 presents a much more favorable approach from a wetland's perspective. Not only does it increase flood storage volume in the region, but it also requires no filling to LUW. Any fill within the river will be hard to permit through the various agencies, including DEP and ACOE. It will also require mitigation to replace lost wetland resource areas.

#### 8.2.2 Alternative B – Vegetative Berm Over Rip Rap Slope

The vegetative berm option would be a combination of rip rap slope and vegetative berm. The rip rap would have the same stone size and slope as Alternative A but would stop approximately 3.5-feet above

the river bed with the vegetative berm extending to the top of the slope. The slope of the vegetative berm would be 1 vertical to 3 horizontal. As with the rip rap slope, two options are presented for the location of the slope.

- Option 1 is to begin the rip rap slope where the existing wall is located and provide additional flood storage in the sloped area.
- Option 2 is to begin the rip rap slope roughly 3.75-feet north of the south wall (in the river) which would provide no additional flood storage but would maintain the currently available flood storage.

#### 8.2.2.1 *Regulatory Impacts*

Environmental resources that will be impacted with both vegetative berm options include the following (all calculations are estimates based on current conceptual designs):

- Bank of perennial stream
  - For both options, an estimated 1,335 linear feet (lf) of bank will be impacted
- Land under water
  - Option 1 will result in LUW impacts of 6,000 sf and dredging of 21,400 cubic feet (cf)
  - Option 2 will result in LUW impacts of 10,600 sf, 41,400 cf of dredge, and unknown amount of fill
- 100-year flood zone
  - Option 1 would increase flood storage by adding approximately 26,000 CF of additional flood storage due to the removal of the existing stone masonry wall
  - Option 2 will have negligible impact to the flood zone
- Riverfront area
  - Option 1 will impact 28,500 sf
  - Option 2 will impact 21,800 sf

#### 8.2.2.2 *Potential Permits*

Potential permits required for both vegetative berm alternatives include the following:

- MA Wetlands Protection Act Notice of Intent
- MassDEP 401 Water Quality Certification
- MassDEP Chapter 91 submission
- MEPA Environmental Notification Form
- US Army Corps of Engineers Individual Permit

A description of these permits and typical required documents has been included in Appendix J.

#### 8.2.2.3 *Permit Costs*

Permit costs can vary depending on resource area impacts, project complexity, and reviewer comments. The typical range of costs per likely required permit is provided on the following page.



## Permit Costs for Vegetative Berm Option

Permit	Minimum Cost	Maximum Cost
MassDEP Wetlands NOI	5,000	10,000
MassDEP 401 WQC	5,000	10,000
MassDEP Ch 91	5,000	10,000
MEPA ENF	5,000	10,000
ACOE IP	5,000	10,000
<b>TOTAL</b>	<b>25,000</b>	<b>50,000</b>

Option 2 would most likely incur an additional \$10,000 -15,000 for additional studies related to mitigation/compensation design.

#### 8.2.2.4 Permit Approval Schedule

Much like Alternative A the approach of Alternative B would be similar with a review through the MEPA ENF process followed by a simultaneous review by the other agencies. In all, the environmental permit review process could take between **seven (7) and fifteen (15) months**.

#### 8.2.2.5 Alternative Favorability

Similar to Alternative A, Alternative B, Option 1 presents a much more favorable approach from a wetland's perspective. Not only does it increase flood storage volume in the region, but it also requires no filling to LUW. Any fill within the river will be hard to permit through the various agencies, including DEP and ACOE. It will also require mitigation to replace lost wetland resource areas.

The vegetative berm approach also has the added benefit of providing habitat to the stream. In many agencies minds this presents a greener solution than the rip rap slope does and could potentially be seen as the desired and preferred alternative from a regulatory perspective.

#### 8.2.3 Alternative C – Sheet Pile Wall

A sheet pile wall would require the removal of the existing wall structure. The existing wall structure would be removed after the sheet piles were installed just behind the existing wall. The height of the sheet pile walls can vary along the length of the canal or maintain a constant height. By removing the existing wall after installation of the sheet piles, a small increase in the canal flood storage will be achieved.

- Option 1 consists of a sheet pile wall installed behind the existing wall to an approximate depth of 20 feet below the top of slope. The existing wall structure would be removed after the sheet piles are installed, providing a small increase in flood storage. A concrete cap would be constructed along the top of the sheet pile wall for a more aesthetic look and to cover the jagged top of the sheet piling. An available option for this alternative is architectural cladding, such as a stone veneer matching the aesthetics of the existing wall.
- Option 2 consists of a sheet pile wall installed behind the existing wall. The sheet pile would extend 2-feet above the canal bed, and 13-feet below ground. A rip rap or vegetative slope, much like Alternatives A and B, would then extend from the top of the sheet pile to the top of bank.

### 8.2.3.1 Regulatory Impacts

Environmental resources that will be impacted with this option include the following (all calculations are estimates based on current conceptual designs):

- Bank of perennial stream
  - An estimated 1,335 linear feet (lf) of bank will be impacted
- Land under water
  - Temporary LUW impacts associated with demolition of south wall
- 100-year flood zone
  - Option 1 would increase flood storage by adding approximately 10,700 CF of additional flood storage due to the removal of the existing stone masonry wall
  - Option 2 would provide approximately 37,000 CF of flood storage due to the removal of wall and addition of a rip rap slope. If the slope were constructed as a vegetative berm, the additional flood storage would be increased to 44,000 CF.
- Riverfront area
  - Option 1 will impact 17,200 sf
  - Option 2 will impact 20,000 sf

### 8.2.3.2 Potential Permits

Potential permits required for the sheet pile wall alternative include the following:

- MA Wetlands Protection Act Notice of Intent
- MEPA Environmental Notification Form
- US Army Corps of Engineers Individual Permit
- MassDEP 401 Water Quality Certification

A description of these permits and typical required documents has been included in Appendix K.

### 8.2.3.3 Permit Costs

Permit costs can vary depending on resource area impacts, project complexity, and reviewer comments. The typical range of costs per likely required permit is provided, below.

#### Permit Costs for Sheet Pile Option

Permit	Minimum Cost	Maximum Cost
MassDEP Wetlands NOI	5,000	10,000
MEPA ENF	5,000	10,000
ACOE IP	5,000	10,000
401 WQC	5,000	10,000
Add'l Cost Analysis	5,000	10,000
<b>TOTAL</b>	<b>25,000</b>	<b>50,000</b>

An additional cost analysis may be needed to prove this Alternative is the preferred Alternative. We estimate that additional cost to be \$5,000 -10,000 as explained in Section 8.3.

#### 8.2.3.4 Permit Approval Schedule

Much like Alternative A and B, the approach of Alternative C would be similar with a review through the MEPA ENF process followed by a simultaneous review by the other agencies. The only permit that most likely will not be necessary is the Chapter 91 permit, as there will be no jurisdictional work within the waterway. Although this is only 1 permit fewer than the first alternatives, the CH91 permit has a lengthy review timeframe and by avoiding it, the project could cut the permitting approval process in half. In all, the environmental permit review process could take **up to seven (7) months**.

#### 8.2.3.5 Alternative Favorability

Although this Alternative C - Option 1 is a suitable alternative for repair of the existing south wall, it provides no extra environmental benefit from a regulatory standpoint, with the exception of a marginal flood storage benefit.

Because the current wall is a vertical wall, it would be permissible as a replacement of the existing conditions. However, with other more favorable alternatives present, the City would have to show how other options would be less practicable based on at least the following considerations:

- Costs and whether such costs are reasonable or prohibitive to the owner;
- Existing technology; and
- Logistics considering the overall project purposes

Alternative C- Option 2 presents a more favorable approach than Alternative C - Option 1 from a regulatory perspective as it provides additional flood storage. If combined with the greener solution of a vegetated berm, then it could even provide some habitat benefit, as well.

#### 8.2.4 Alternative D – Cantilever Concrete Retaining Wall

A cantilever concrete retaining wall would replace the existing south wall. Excavation would be required for the placement of the footing. The stem of the concrete wall will be approximately 14 inches wide at the top and about 30 inches wide at the base. A concrete form liner may be used to provide texture or the look of a stone veneer if desired.

##### 8.2.4.1 Regulatory Impacts

Environmental resources that will be impacted with this option include the following (all calculations are estimates based on current conceptual designs):

- Bank of perennial stream
  - An estimated 1,335 linear feet (lf) of bank will be impacted
- Land under water
  - Temporary LUW impacts associated with demolition of south wall
- 100-year flood zone
  - Marginal increase in flood storage from removal of wall
- Riverfront area
  - Will impact 14,800 sf

##### 8.2.4.2 Potential Permits

Potential permits required for the cantilever retaining wall alternative include the following:

- MA Wetlands Protection Act Notice of Intent

- MEPA Environmental Notification Form
- US Army Corps of Engineers Individual Permit
- 401 Water Quality Certification

A description of these permits and typical required documents has been included in Appendix J.

#### 8.2.4.3 Permit Costs

Permit costs can vary depending on resource area impacts, project complexity, and reviewer comments. The typical range of costs per likely required permit is provided on the following page.

#### Permit Costs for Cantilever Retaining Wall Option

Permit	Minimum Cost	Maximum Cost
MassDEP Wetlands NOI	5,000	10,000
MEPA ENF	5,000	10,000
ACOE IP	5,000	10,000
401 WQC	5,000	10,000
Add'l Cost Analysis	5,000	10,000
<b>TOTAL</b>	<b>25,000</b>	<b>50,000</b>

An additional cost analysis may be needed to prove this Alternative is the preferred Alternative. We estimate that additional cost to be \$5,000 -10,000 as explained in Section 8.3.

#### 8.2.4.4 Permit Approval Schedule

Alternative D would replicate the schedule of Alternative C, with a review through the MEPA ENF process followed by a simultaneous review by the other agencies. Again, no CH 91 permit review would be necessary and therefore permitting review timelines would be reduced.

In all, the environmental permit review process could take **up to seven (7) months**.

#### 8.2.4.5 Alternative Favorability

Similar to Alternative C, this alternative is a suitable alternative for repair of the existing south wall, however it provides no extra environmental benefit from a regulatory standpoint. It only provides a marginal flood storage benefit and no habitat benefit to the resource area.

Because the current wall is a vertical wall, it would be permissible as a replacement of the existing conditions. However, with other more favorable alternatives present, the City would have to show how other options would be less practicable based on at least the following considerations:

- Costs and whether such costs are reasonable or prohibitive to the owner;
- Existing technology; and
- Logistics considering the overall project purposes

To make this alternative more favorable the wall could be pushed back farther south, and the river widened to allow for increased flood storage.

### 8.2.5 *Alternative E – Stone Masonry Wall*

The stone masonry wall would replace the existing stone masonry wall with a new concrete footing in the same location. The stem of the wall will be approximately 20 inches wide at the top and 4 feet at the base. The concrete footing would be constructed approximately 4 feet below the stream bed. This alternative would provide no additional flood storage space.

#### 8.2.5.1 *Regulatory Impacts*

Environmental resources that will be impacted with this option include the following (all calculations are estimates based on current conceptual designs):

- Bank of perennial stream
  - An estimated 1,335 linear feet (lf) of bank will be impacted
- Land under water
  - Temporary LUW impacts associated with demolition of south wall
- 100-year flood zone
  - Marginal increase in flood storage from removal of wall
- Riverfront area
  - Will impact 15,900 sf

#### 8.2.5.2 *Potential Permits*

Potential permits required for the stone masonry wall alternative include the following:

- MA Wetlands Protection Act Notice of Intent
- MEPA Environmental Notification Form
- US Army Corps of Engineers Individual Permit
- 401 Water Quality Certification

A description of these permits and typical required documents has been included in Appendix K.

#### 8.2.5.3 *Permit Costs*

Permit costs can vary depending on resource area impacts, project complexity, and reviewer comments. The typical range of costs per likely required permit is provided below

#### Permit Costs for Stone Masonry Wall Option

Permit	Minimum Cost	Maximum Cost
MassDEP Wetlands NOI	5,000	10,000
MEPA ENF	5,000	10,000
ACOE IP	5,000	10,000
401 WQC	5,000	10,000
Add'l Cost Analysis	5,000	10,000
<b>TOTAL</b>	<b>25,000</b>	<b>50,000</b>

An additional cost analysis may be needed to prove this Alternative is the preferred Alternative. We estimate that additional cost to be \$5,000 -10,000 as explained in Section 8.3.

#### 8.2.5.4 Permit Approval Schedule

Alternative E would replicate the schedule of Alternative C and D, with a review through the MEPA ENF process followed by a simultaneous review by the other agencies. Again, no CH 91 permit review would be necessary and therefore permitting review timelines would be reduced.

In all, the environmental permit review process could take **up to seven (7) months**

#### 8.2.5.5 Alternative Favorability

Similar to both Alternatives C and D, this alternative is a suitable alternative for repair of the existing south wall, however it provides no extra environmental benefit from a regulatory standpoint. It only provides a marginal flood storage benefit and no habitat benefit to the resource area.

Because the current wall is a vertical wall, it would be permissible as a replacement of the existing conditions. However, with other more favorable alternatives present, the City would have to show how other options would be less practicable based on at least the following considerations:

- Costs and whether such costs are reasonable or prohibitive to the owner;
- Existing technology; and
- Logistics considering the overall project purposes

To make this alternative more favorable the wall could be pushed back farther south, and the river widened to allow for increased flood storage.

### 8.3 Permitting Summary and Recommendations

Weston & Sampson has produced five (5) design alternatives (three with sub options for a total of eight total alternatives) for repair / replacement options for the south wall along the North River Canal in order to support the proposed construction of a Riverwalk and to improve the flood resilience along the North River Canal. Each of these designs has been evaluated for five (5) different variables, including impacts to protected environmental resources, required permits, permit costs, permit approval schedule and regulatory favorability. For each alternative, each variable was given a value, with lower values indicating lesser preferred alternative results. A summary table showing each alternative with five different variable results are provided in *Appendix K*.

In general, the more complicated the wall repair, the greater the number of environmental resources and impact areas, which results in a greater number of environmental permits being required along with increased costs and schedule duration. As a result of this analysis, it should be noted that the alternatives fall into one of two groups, those that require permanent work within land under water (Alternative A and B), and those that do not require permanent work within land under water (Alternative C, D and E). For those alternatives that impact land under water, an additional permit (MassDEP Chapter 91) will be required and result in additional project costs and permitting approval duration.

In general, the only difference between these two groups of alternatives from a permit cost and schedule context is approximately \$5k-\$10k in costs and 7-8 months in review. However, when providing additional overall project cost analysis study, the cost of C, D and E are comparable to Option 1 in both Alternatives A and B. Furthermore Option 2 in Alternatives A and B add even more costs associated with further design required for mitigation of lost resource areas. Therefore, Option 1 in Alternative A and B, Alternative C, Alternative D, and Alternated E all have roughly the same costs when factoring in the Permit costs and Additional Overall Cost Analysis. The additional studies required as part of Option



2 for Alternative A and B would make those choices more expensive. See table below:

### Potential Permitting Costs

	Alt A, Opt. 1	Alt A, Opt. 2	Alt. B, Opt. 1	Alt. B, Opt. 2	Alt. C, Opt. 1	Alt. C, Opt. 2	Alt. D	Alt. E
<b>Costs (\$)</b>	\$25,000 - \$50,000	\$35,000 - \$65,000	\$25,000 - \$50,000	\$35,000 - \$65,000	\$25,000 - \$50,000	\$25,000 - \$50,000	\$25,000 - \$50,000	\$25,000 - \$50,000

Given the relatively small difference in cost and timing of the permits required for each alternative, Weston & Sampson evaluated the anticipated favorability of each alternative from a regulatory perspective. Each permitting agency will be evaluating the potential impacts of resource areas that will be impacted by the proposed alternative; most notably bank and land under water. Although any repair alternative work will be performed within the flood plain, the intent of the overall project will be to increase flood storage and not fill the flood plain, which will also be looked at favorably by the regulatory agencies. Additionally, work will also be completed in the riverfront area, however the portion of the riverfront area that will be impacted is previously developed and any project of this magnitude that has a goal of cleaning up the riverfront is anticipated to be looked at favorably by the permitting agency reviewer.

The following is an excerpt of the performance standards for bank and land under water in the wetland's protection act:

*"General Performance Standards (Land Under Water).*

(a) Where the presumption set forth in 310 CMR 10.56(3) is not overcome, any proposed work within Land under Water Bodies and Waterways shall not impair the following:

1. The water carrying capacity within the defined channel, which is provided by said land in conjunction with the banks;
2. Ground and surface water quality;
3. The capacity of said land to provide breeding habitat, escape cover and food for fisheries; and
4. The capacity of said land to provide important wildlife habitat functions. A project or projects on a single lot, for which Notice(s) of intent is filed on or after November 1, 1987, that (cumulatively) alter(s) up to 10% or 5,000 square feet (whichever is less) of land in this resource area found to be significant to the protection of wildlife habitat, shall not be deemed to impair its capacity to provide important wildlife habitat functions. Additional alterations beyond the above threshold may be permitted if they will have no adverse effects on wildlife habitat, as determined by procedures established under 310 CMR 10.60."

*"General Performance Standard (BANK).*

(a) Where the presumption set forth in 310 CMR 10.54(3) is not overcome, any proposed work on a Bank shall not impair the following:

1. the physical stability of the Bank;
2. the water carrying capacity of the existing channel within the Bank;
3. groundwater and surface water quality;
4. the capacity of the Bank to provide breeding habitat, escape cover and food for fisheries;
5. the capacity of the Bank to provide important wildlife habitat functions. A project or projects on a single lot, for which Notice(s) of Intent is filed on or after November 1, 1987, that (cumulatively) alter(s) up to 10% or 50 feet (whichever is less) of the length of the bank found to be significant to the protection of wildlife habitat, shall not be deemed to impair its capacity to provide important wildlife habitat functions. Additional alterations beyond the above threshold may be permitted if they will have no adverse effects on wildlife habitat, as determined by procedures contained in 310 CMR 10.60."

Although they are listed as two (2) different resource areas, the performance standards for both are very similar. Essentially LUW and Bank need to provide the following:

- Stability,
- Water carrying capacity,
- Ground water and surface water quality,
- Habitat for fisheries, and
- Capacity of land to provide other wildlife habitat functions

Although these are just performance standards under the Massachusetts Wetlands Protection Act, and both resource areas are also protected under the Army Corp Section 404 and Mass DEP Section 401 of the Clean Water Act, as well as Mass DEP Chapter 91 regulations, the intent of the protection remains the same throughout.

So, when evaluating each alternative, we must review them to these standards to see if they Meet (M), Improve (I) or Diminish (D) each standard.

#### Alternative Evaluation against Performance Standards

	Stability	Water Carrying	Water Quality	Habitat for Fisheries	Wildlife Habitat	Total
Alternative A Option 1	Improve	Improve	Improve	Improve	Meet	4 I, 1 M
Alternative A Option 2	Improve	Diminish	Diminish	Diminish	Meet	1 I, 1 M, 3 D
Alternative B Option 1	Improve	Improve	Improve	Improve	Improve	5 I
Alternative B Option 2	Improve	Diminish	Diminish	Diminish	Improve	2 I, 3 D
Alternative C Option 1	Improve	Improve	Meet	Meet	Meet	2 I, 3 M
Alternative C Option 2	Improve	Improve	Meet	Meet	Improve (if veg berm)	3 I, 2 M
Alternative D	Improve	Meet	Meet	Meet	Meet	1 I, 4 M
Alternative E	Improve	Meet	Meet	Meet	Meet	1 I, 4 M

As can be seen above, Option 2 for both Alternative A and B would diminish the quality of the resource areas impacted by the project. Based on the location of the wall in both scenarios, fill would need to be placed within the existing land under water. This would diminish the river's existing ability to carry water, treat the water and provide fish habitat. Because these alternatives would result in a diminished resource area, the agencies would more than likely require some type of mitigation to replicate the lost function of the resource area lost. This would require additional studies (hydraulic, water quality, habitat evaluations, etc.) and design of replication/restoration areas in order to determine exactly what functions were being lost and how to best replicate them on the same stretch of river.

Alternatives D, and E would meet the standards, but would provide no benefit or improvement, except for stabilizing the wall. Alternatives C - Option 1 rates slightly higher as it would improve on 1 standard by increasing water carrying capacity. Because the river is currently confined between two vertical walls

throughout this stretch, an argument could be made that all three alternatives should be allowable, as the work will not diminish what currently exists. Agencies would most likely require additional information to determine why these three alternatives were preferred over others that may provide more benefit to the site. Additional information could include an overall project cost analysis of each alternative and additional information on property rights along the river. For instance, acquisition of private land in order to complete Alternative B may be cost prohibitive and not preferred over another alternative that had a smaller footprint and required less acquisition of land. The proponent would be required to prove that the selected alternative, although possibly not the most environmentally preferred, was selected for other preferential reasons.

Alternative B - Option 1, Alternative A - Option 2, and Alternative C - Option 2 provide the most favorable alternatives when compared to the standards. Because these options include the expansion of the width of the river, the creation of Land Under Water and the gradual sloping of the bank, all three options would improve upon various criteria within the standards.

Although not called out specifically in the performance standards there are still other environmental considerations that will factor into overall favorability. Special consideration should also be given to alternatives that provide other benefits, such as the creation of flood storage volume. When rating each alternative based on their potential long-term impact to increasing storage along the river, Alternative B - Option 1, Alternative A - Option 1 and Alternative C - Option 2 rate out the most favorable, in that order.

In summary, the evaluated alternatives ranked accordingly highest to lowest based on regulatory favorability:

- Alternative B - Option 1 (provides 5 improvements and provides flood storage)
- Alternative A - Option 1 (provides 4 improvements and provides flood storage)
- Alternative C - Option 2 (provides 3 improvement and provides flood storage)
- Alternative C - Option 1 (provides 2 improvement and meets others)
- Alternative D (provides 1 improvement, additional study required to show why selected)
- Alternative E (provides 1 improvement, additional study required to show why selected)
- Alternative B - Option 2 (will diminish resource area, additional studies for impact and replication)
- Alternative A - Option 2 (will diminish resource area, additional studies for impact and replication)

Utilizing the five standards and flood plain considerations mentioned above, we have included a Permitting Strategy Matrix on the following page for the project. Although the matrix rates out four alternatives relatively close, careful consideration should be taken to which variables are more important to the client.

Given the relatively small difference in cost and timing of the permits (when compared to the general wall repair costs, etc.) these factors are less likely to impact the City's decisions as to which alternative to choose. More important factors, such as favorability or the likelihood and ease of which approvals can be obtained from the agencies might be the governing factor. This would be evident in the favorability ranking of each alternative. Please see the Permitting Strategy Matrix Summary provided on the following page:

## Permitting Strategy Matrix Summary

	A.1 - Rip Rap Slope	A.2 - Rip Rap Slope	B.1 - Vegetative Berm	B.2 - Vegetative Berm	C.1 - Sheet Pile Wall	C.2- Sheet Pile Wall w/ Sloped Bank	D - Cantilever Concrete Retaining Wall	E - Stone Masonry Wall
Impacts (1-7)	3	1	4	2	5	5	7	6
Permits (1-7)	5	1	5	1	6	6	6	6
Costs (1-7)	3	1	3	1	3	3	3	3
Favorability (1-8)	7	1	8	2	3	6	3	3
Schedule (1-7)	3	1	3	1	4	4	4	4
<b>Total Average</b>	4.2	1.0	4.6	1.4	4.2	4.8	4.6	4.4

lower number = less preferred alternative

higher number = more preferred alternative

## 9.0 COMPREHENSIVE COMPARATIVE MATRIX

The following is a comprehensive comparative matrix to assist the City when comparing each of the repair design alternatives outlined in this report. Please note that this is not a final construction cost estimate. The preliminary cost estimates provided for each conceptual alternative only include major items associated with each wall design and are to be used for comparative purposes only. These preliminary cost estimates are not representative of the final construction costs as they do not include minor items that will be required for the implementation of each alternatives such as site preparation work, clearing and grubbing, erosion controls, etc.

Please refer to the assumptions presented in ***Appendix I – Wall Alternative Cost Estimates***. Please note that the cost estimates assume that only impacted soils associated with wall repair activities are removed from the site and are transported and disposed of at a licensed, out-of-state non-hazardous disposal/recycling facility. This does not include any soils that may need to be removed from the site associated with the future construction of the proposed Riverwalk, etc., as the preliminary design of the Riverwalk has not been completed at this time.

ENGINEERING EVALUATION & DESIGN ALTERNATIVE  
ANALYSIS

	Resiliency & Flood Storage	Durability & Maintenance	Estimated Excavation	Construction & Easements	Permitting & Regulatory Favorability	Preliminary Cost Estimate *
<b>Alt A - Rip Rap Option 1</b>	<ul style="list-style-type: none"> <li>- Approx. 18 cu.ft./ft additional flood storage</li> <li>- Future height increase possible</li> <li>- Max. % of parcels protected ranges from 30%-55%</li> </ul>	<ul style="list-style-type: none"> <li>- Minimum design service life 50 years</li> <li>- Low maintenance (i.e. replace dislodged riprap after storm events)</li> </ul>	<ul style="list-style-type: none"> <li>- Requires excavating ~3000 CY of contaminated soils</li> </ul>	<ul style="list-style-type: none"> <li>- Requires 25-ft permanent easement from edge of river</li> <li>- Additional 15-ft temporary easement for construction</li> <li>- Approx. 5-month construction</li> </ul>	<ul style="list-style-type: none"> <li>- 4<sup>th</sup> in Total Permitting Favorability (tie)</li> <li>- 2<sup>nd</sup> in Regulatory Favorability</li> <li>- 4 Improved Resources</li> </ul>	\$2,607,000 – \$9,926,000
<b>Alt A - Rip Rap Option 2</b>	<ul style="list-style-type: none"> <li>- Approx. 1 cu. ft./ft. additional flood storage</li> <li>- Future height increase possible</li> <li>- Max. % of parcels protected ranges from 11%-17%</li> </ul>	<ul style="list-style-type: none"> <li>- Minimum design service life 50 years</li> <li>- Low maintenance (i.e. replace dislodged riprap after storm events)</li> </ul>	<ul style="list-style-type: none"> <li>- Requires excavating ~1500 CY of contaminated soils</li> </ul>	<ul style="list-style-type: none"> <li>- Requires 21-ft permanent easement from edge of river</li> <li>- Additional 15-ft temporary easement for construction</li> <li>- Approx. 5-month construction</li> </ul>	<ul style="list-style-type: none"> <li>- Lowest scoring (8<sup>th</sup>) alternative in Total Permitting Favorability</li> <li>- Lowest (8<sup>th</sup>) Regulatory Favorability</li> <li>-Diminishes Resources &amp; Need for additional studies</li> </ul>	\$2,615,000 - \$8,459,000
<b>Alt B - Vegetative Berm Option 1</b>	<ul style="list-style-type: none"> <li>- Approx. 20 cu.ft./ft. additional flood storage</li> <li>- Future height increase possible</li> <li>- Max. % of parcels protected ranges from 31%-60%</li> </ul>	<ul style="list-style-type: none"> <li>- Minimum design service life 50 years</li> <li>- Low to Moderate maintenance required (i.e. maintain vegetation, replace rip rap and/or soils, etc. after storm events)</li> </ul>	<ul style="list-style-type: none"> <li>- Requires excavating ~3000 CY of contaminated soils</li> </ul>	<ul style="list-style-type: none"> <li>- Requires 28-foot permanent easement from edge of river</li> <li>- Additional 15-foot temporary easement for construction</li> <li>- Approx. 5-9-month construction (depends on growing season)</li> </ul>	<ul style="list-style-type: none"> <li>- 2<sup>nd</sup> in Total Permitting Favorability (tie)</li> <li>- Highest (1<sup>st</sup>) Regulatory Favorability</li> <li>-5 Improved Resources</li> </ul>	\$2,479,000 - \$9,712,000



ENGINEERING EVALUATION & DESIGN ALTERNATIVE  
ANALYSIS

<b>Alt B - Vegetative Berm Option 2</b>	<ul style="list-style-type: none"> <li>- Approx. 1 cu.ft./ft. additional flood storage</li> <li>- Future height increase possible</li> <li>- Max. % of parcels protected ranges from 11%-17%</li> </ul>	<ul style="list-style-type: none"> <li>- Minimum design service life 50 years</li> <li>- Low to Moderate maintenance required (i.e. maintain vegetation, replace rip rap and/or soils, etc. after storm events)</li> </ul>	<ul style="list-style-type: none"> <li>- Requires excavating ~1400 CY of contaminated soils</li> </ul>	<ul style="list-style-type: none"> <li>- Requires 25-foot permanent easement from edge of river</li> <li>- Additional 15-foot temporary easement for construction</li> <li>- Approx. 5-9-month construction (depends on growing season)</li> </ul>	<ul style="list-style-type: none"> <li>- 5<sup>th</sup> in Total Permitting Favorability</li> <li>- 7<sup>th</sup> (second to last) in Regulatory Favorability</li> <li>- Diminishes Resources &amp; Need for additional studies</li> </ul>	<p>\$2,421,000 - \$8,103,000</p>
<b>Alt C – Sheet Pile Wall Option 1</b>	<ul style="list-style-type: none"> <li>- Approx. 8.5 cu.ft./ft. additional flood storage</li> <li>- Future height increase possible</li> <li>- Max. % of parcels protected ranges from 20%-45%</li> </ul>	<ul style="list-style-type: none"> <li>- Minimum design service life 75 years</li> <li>- Low maintenance required (i.e. monitor sheet piles for corrosion, crack and spall repairs of concrete cap)</li> </ul>	<ul style="list-style-type: none"> <li>- Requires excavating ~400 CY of contaminated soils</li> </ul>	<ul style="list-style-type: none"> <li>- Requires 13-foot permanent easement from edge of river</li> <li>- Additional 15-foot temporary easement for construction</li> <li>- Specialized construction methods</li> <li>- Approx. 4-5-month construction</li> </ul>	<ul style="list-style-type: none"> <li>- 4<sup>th</sup> in Total Permitting Favorability (tie)</li> <li>- 4<sup>th</sup> in Regulatory Favorability</li> <li>- Limited Improvements &amp; Need for additional studies</li> </ul>	<p>\$2,678,000 - \$3,422,000</p>
<b>Alt C – Sheet Pile Wall Option 2 w/ Sloped Bank</b>	<ul style="list-style-type: none"> <li>- Approx. 20-25 cu.ft./ft. additional flood storage</li> <li>- Future height increase possible</li> <li>- Max. % of parcels protected ranges from 31%-60%</li> </ul>	<ul style="list-style-type: none"> <li>- Minimum design service life 50 years</li> <li>- Low to Moderate maintenance required (i.e. monitor sheet piles for corrosion; replace dislodged rip rap after storm events; maintain vegetative berm which is less stable than rip rap during and after storm events and may require minor repair)</li> </ul>	<ul style="list-style-type: none"> <li>- Requires excavating:  ~2600 CY of contaminated soils for Rip Rap option  ~1500 CY of contaminated soils for Earthen Berm</li> </ul>	<ul style="list-style-type: none"> <li>- Requires 28-foot permanent easement from edge of river</li> <li>- Additional 15-foot temporary easement for construction</li> <li>- Approx. 5-month construction</li> </ul>	<ul style="list-style-type: none"> <li>- Highest (1<sup>st</sup>) in Total Permitting Favorability</li> <li>- 3<sup>rd</sup> in Regulatory Favorability</li> <li>- 3 Improved Resources but Meet all others</li> </ul>	<p>\$2,332,000 - \$5,060,000 (w/ Earthen Berm)  \$2,726,000 - \$7,214,000 (w/ Rip Rap)</p>

ENGINEERING EVALUATION & DESIGN ALTERNATIVE ANALYSIS

<p><b>Alt D - Concrete Cantilever Retaining Wall</b></p>	<ul style="list-style-type: none"> <li>- No increased river flood storage</li> <li>- Future height increase possible</li> <li>- No % of parcels protected</li> </ul>	<ul style="list-style-type: none"> <li>- Minimum design service life 75 years</li> <li>- Moderate maintenance required (i.e. crack and spall repairs)</li> </ul>	<ul style="list-style-type: none"> <li>- Requires excavating ~1900 CY of contaminated soils</li> </ul>	<ul style="list-style-type: none"> <li>- Requires 13-foot permanent easement from edge of river</li> <li>- Additional 15-foot temporary easement for construction</li> <li>- Requires removal of organic soils to prevent settlement</li> <li>- Approx. 6-8-month construction</li> </ul>	<ul style="list-style-type: none"> <li>- 2<sup>nd</sup> in Total Permitting Favorability (tie)</li> <li>- 5<sup>th</sup> in Regulatory Favorability</li> <li>- limited Improvement &amp; need for additional studies</li> </ul>	<p>\$4,832,000 - \$9,834,000</p>
<p><b>Alt E - Stone Masonry Wall</b></p>	<ul style="list-style-type: none"> <li>- No additional river flood storage</li> <li>- Future height increase possible</li> <li>- No % of parcels protected</li> </ul>	<ul style="list-style-type: none"> <li>- Minimum design service life 50 years</li> <li>- Moderate maintenance required (i.e. repointing of mortar, replace dislodged stones)</li> </ul>	<ul style="list-style-type: none"> <li>- Requires excavating ~2100 CY of contaminated soils</li> </ul>	<ul style="list-style-type: none"> <li>- Requires 13-foot permanent easement from edge of river</li> <li>- Additional 15-foot temporary easement for construction</li> <li>- Requires removal of organic soils to prevent settlement</li> <li>- Approx. 7-9-month construction</li> <li>- Requires removal of organic soils to prevent settlement</li> </ul>	<ul style="list-style-type: none"> <li>- 3<sup>rd</sup> in Total Permitting Favorability</li> <li>- 6<sup>th</sup> in Regulatory Favorability</li> <li>- limited Improvement &amp; need for additional studies</li> </ul>	<p>\$4,328,000 - \$9,702,000</p>

\* Upper cost range assumes all impacted soil/sediment subject to federal/EPA land ban disposal restrictions

## 10.0 CONCLUSIONS

The comparative matrix in the previous section was used to determine the highest-ranking wall alternative option for this project. Factors with the most importance during this decision were: cost, quantity of impacted soils requiring excavation and off-site disposal, volume of dredged material, favorability by regulatory agencies in obtaining permits, feasibility of providing additional flood storage, and the ease of adding a Riverwalk behind the wall.

In general, the least expensive alternatives were: 1) Alternatives C – Sheet Pile options; 2) Alternatives B – Vegetative Berm options; and Alternatives A- Rip Rap options. The alternatives which require the least estimated amount of material to be dredged from the canal are: 1) Alternatives C – Sheet Pile options; 2) Alternative D - Cantilever Wall; and 3) Alternative E - Stone Masonry wall. Adding a Riverwalk behind the sheet pile wall option 1, concrete cantilever wall or stone masonry wall may prove difficult at certain locations where a cantilever walkway would become necessary. At those difficult locations, the two rip rap options, the two vegetative berm options, and sheet pile option 2 would allow for the use of piers to avoid a cantilever walkway and thus likely reduce costs.

Therefore, Alternative C – Sheet Pile Wall Option 2 with Sloped Bank is the highest scoring alternative. However, Alternative C- Option 2 may not be feasible along the entire length due to existing structures and grade, such as the parking lot at 21 Caller Street, and may require a limited length of one of the other wall alternatives to be considered. As an example, the Sheet Pile Wall Option 1 could be used for a short distance along the bank until a larger portion of land is available behind the wall to return to the Sheet Pile Wall Option 2. The feasibility in areas such as 21 Caller Street will need to be further evaluated during the preliminary design and may depend on other factors such as property easements or acquisition potential.

Other well-scoring options during the comparison evaluation were: Alternative C - Sheet Pile Wall - Option 1; Alternative B - Vegetative Berm - Option 1; and Alternative A - Rip Rap - Option 1. The highest-ranking wall option, Alternative C - Sheet Pile Wall - Option 2 with Sloped Bank, combines all the favorable qualities of Alternatives A and B with the favorable qualities of Sheet Pile Option 1 and provides the highest percentage of potential parcel protection for all six flood-climate change projection scenarios.

While Alternative C - Sheet Pile Wall options generally cost about the same as Alternative B - Vegetative Berm Option 1, the sheet pile walls' low maintenance, ease of construction and long lifespan make it a good option and this alternative also does not require any material to be dredged from the canal. Alternative A - Rip Rap Option 1 was ranked closely behind Alternative B because of its similar characteristics to the Vegetative Berm Option 1 but ranked slightly lower due to its greater construction costs and lower total permitting favorability. The estimated cost of Alternative C – Sheet Pile Wall – Option 2 is slightly lower than these other well-scoring options due to the limited excavation and channel dredging required. Alternatives A – Option 1, B – Option 1 and C – Option 2 require roughly the same easement widths.

## 11.0 REFERENCES

This report has prepared the report for the use by the City of Peabody and the Massachusetts Executive Office of Energy & Environmental Affairs (MassEEA), and the design and construction teams for this project and this site only. The information herein could be used for bidding or estimating purposes but should not be construed as a warranty of subsurface conditions. We have made observations only at the aforementioned locations and only to the stated depths. These observations do not reflect soil types, strata thicknesses, or water levels that may exist between observations. Weston & Sampson should be retained during final design to complete additional geotechnical analyses as necessary and review final design and specifications to ensure that our recommendations are suitably followed.

The findings provided by Weston & Sampson in this report are based solely on the information reported in this document. Future subsurface investigations, sampling, and/or other information that was not available to Weston & Sampson at the time of the study, may result in a modification of the findings stated in this report.

Should additional information become available concerning this project site or neighboring properties, which could directly impact the Site in the future, that information should be made available to Weston & Sampson for review so that, if necessary, conclusions presented in this report may be modified.

The preceding recommendations should be considered preliminary, as actual soil conditions may vary. In order for our recommendations to be final, Weston & Sampson should be retained to observe actual subsurface conditions encountered during construction. Our observations will allow us to interpret actual conditions and adapt our recommendations if needed.

The conclusions of this report are based on project site conditions observed by Weston & Sampson personnel at the time of the study, information provided by the City of Peabody, and samples collected and analyzed on the dates shown or stated in this report. Any modification of the report without written verification or adaptation by Weston & Sampson, as appropriate for the specific purpose intended, will be at the City and MassEEA's sole risk and without liability or legal exposure to Weston & Sampson or to Weston & Sampson's consultants. Within the limitations of scope, schedule and budget, our services have been executed in accordance with the generally accepted practices in this area at the time this report was prepared. No warranty, expressed or implied, is given.

APPENDIX C  
MAPS



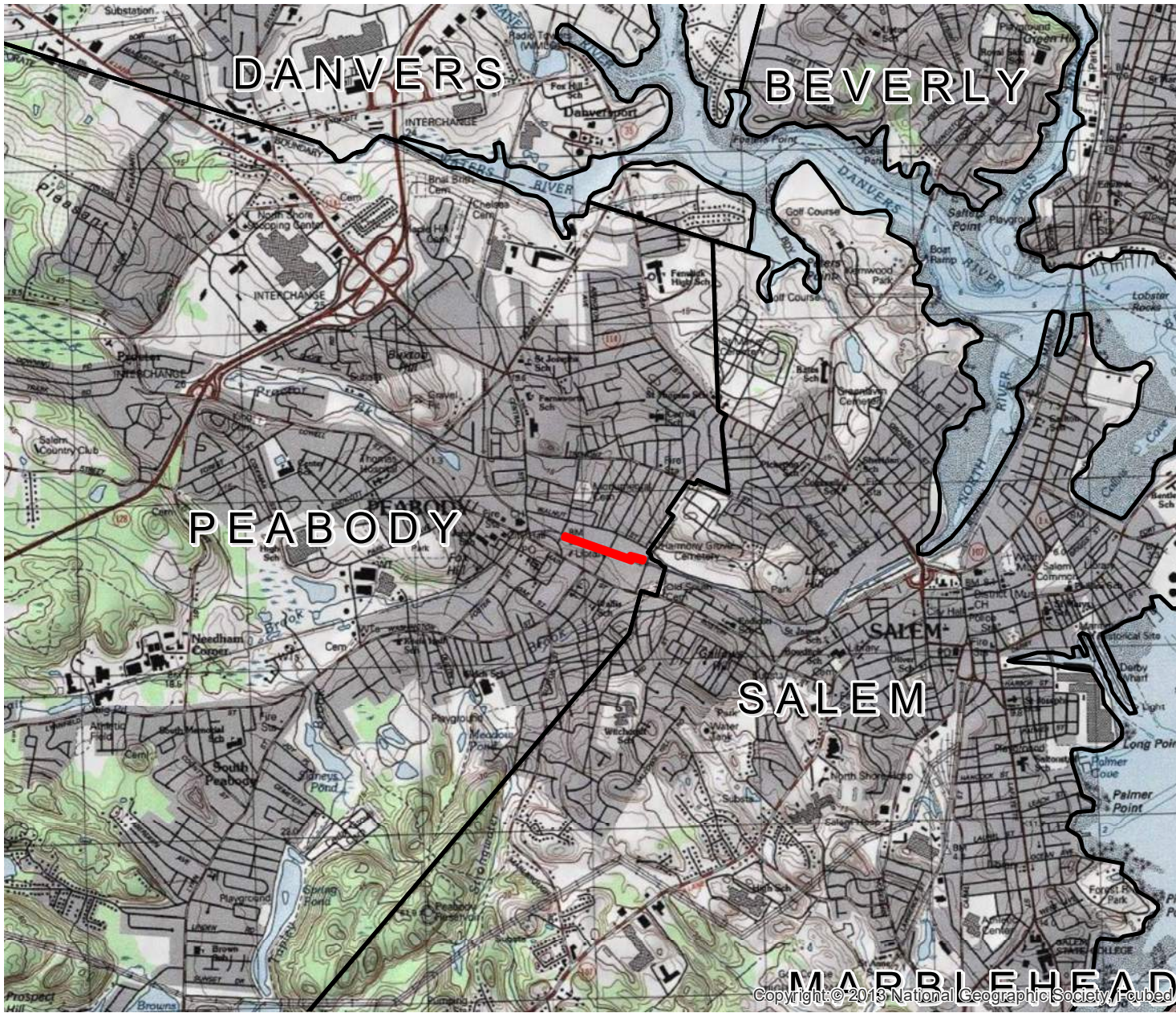

### Legend

 Work Area

**FIGURE 1**

Riverwalk  
Peabody, MA

Locus Map

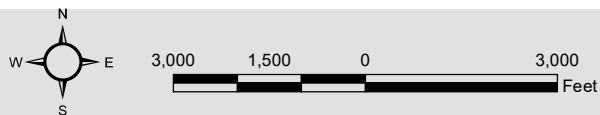

Data Source: Office of Geographic and Environmental Information (MassGIS),  
Commonwealth of Massachusetts Executive Office of Environmental Affairs





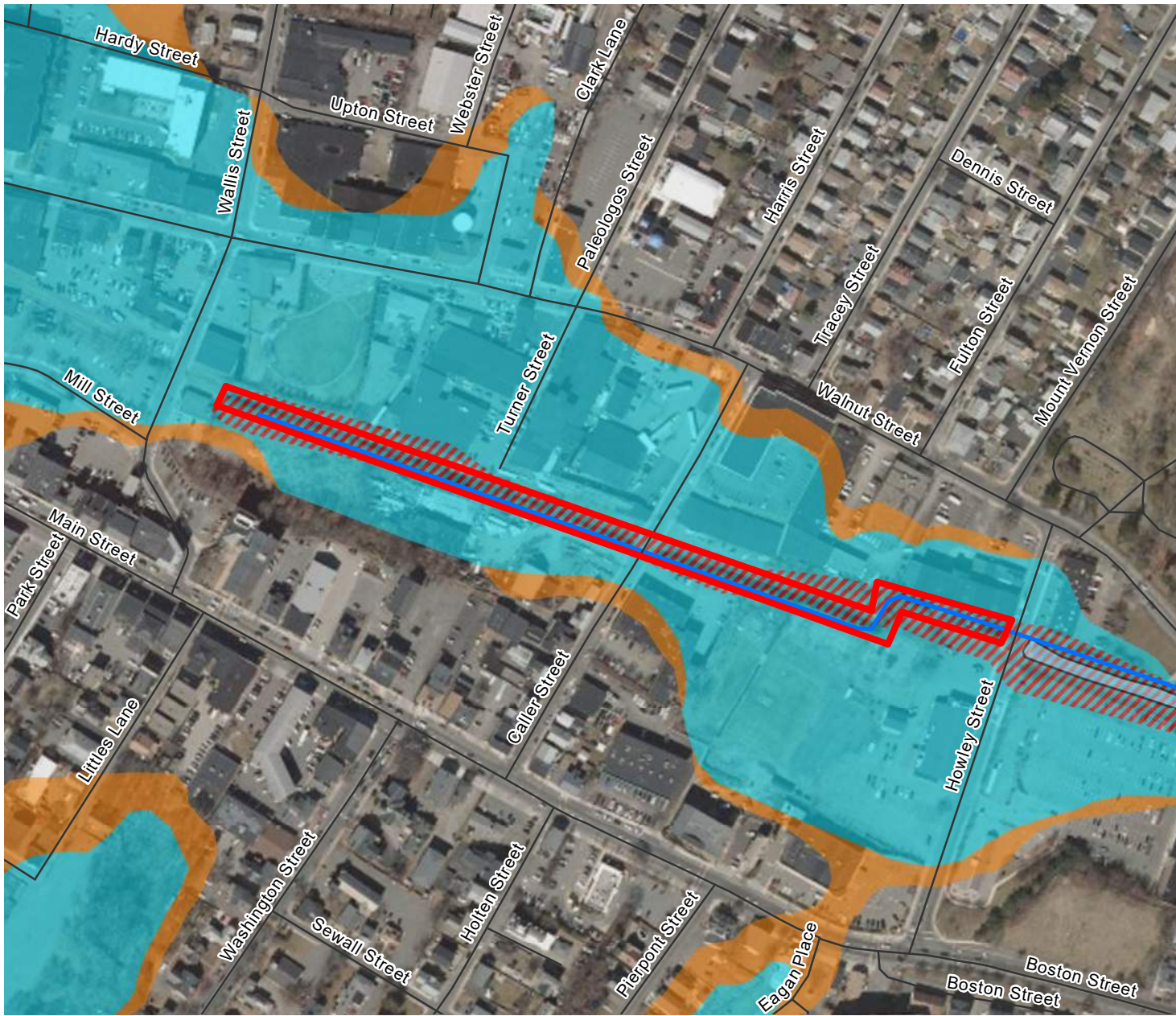

- Legend**
- Work Area
  - Perennial Stream
  - Intermittent Stream
  - Marsh/Bog
  - Wooded marsh
  - Cranberry Bog
  - Salt Marsh
  - Open Water
  - Reservoir (with PWSID)
  - Tidal Flats
  - Beach/Dune
  - ACECs
  - ACECs
  - NHESP Habitats
  - NHESP Estimated Habitats of Rare Wildlife
  - NHESP Priority Habitats of Rare Species
  - NHESP Certified Vernal Pools
  - NHESP Potential Vernal Pools
  - FEMA National Flood Hazard Layer**
  - Flood Zone Designations**
  - A: 1% Annual Chance of Flooding, no BFE
  - AE: 1% Annual Chance of Flooding, with BFE
  - AE: Regulatory Floodway
  - AH: 1% Annual Chance of 1-3ft Ponding, with BFE
  - AO: 1% Annual Chance of 1-3ft Sheet Flow Flooding, with Depth
  - VE: High Risk Coastal Area
  - D: Possible But Undetermined Hazard
  - X: 0.2% Annual Chance of Flooding
  - X: Reduced Flood Risk due to Levee
  - Area Not Included
  - Area with no DFIRM - Paper FIRMs in Effect
  - Outstanding Resource Waters**
  - Public Water Supply Contributor
  - ORW for ACEC
  - ORW for both Water Supply and Other

**FIGURE 2**  
Riverwalk  
Peabody, MA

Environmental  
Resource Map

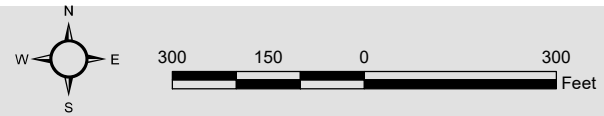

Data Source: Office of Geographic and Environmental Information (MassGIS),  
Commonwealth of Massachusetts Executive Office of Environmental Affairs





# National Flood Hazard Layer FIRMette



70°55'35"W 42°31'42"N

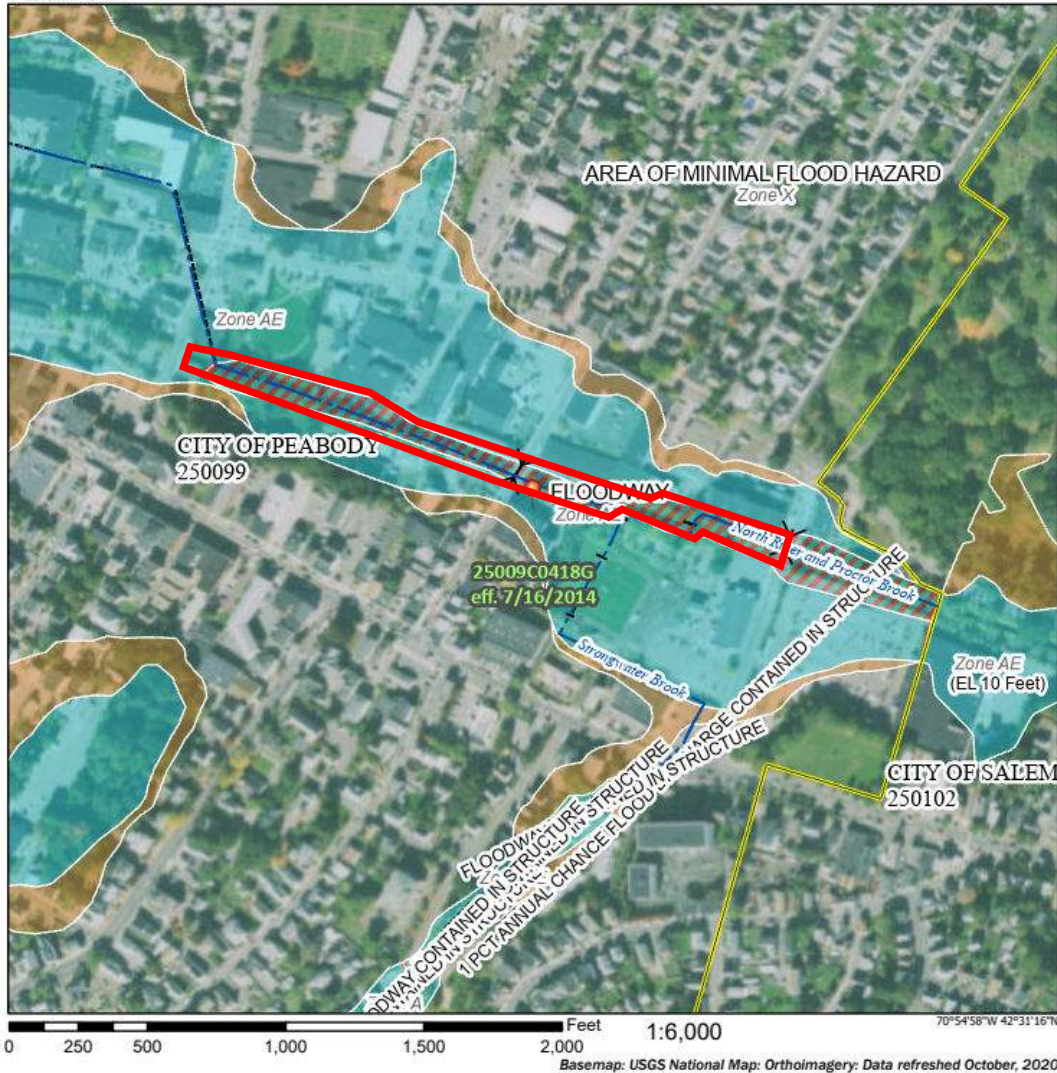

## Legend

SEE FIS REPORT FOR DETAILED LEGEND AND INDEX MAP FOR FIRM PANEL LAYOUT

SPECIAL FLOOD HAZARD AREAS		Without Base Flood Elevation (BFE) Zone A, V, A99
		With BFE or Depth Zone AE, AO, AH, VE, AR
		Regulatory Floodway
OTHER AREAS OF FLOOD HAZARD		0.2% Annual Chance Flood Hazard, Areas of 1% annual chance flood with average depth less than one foot or with drainage areas of less than one square mile Zone X
		Future Conditions 1% Annual Chance Flood Hazard Zone X
		Area with Reduced Flood Risk due to Levee. See Notes, Zone X
		Area with Flood Risk due to Levee Zone D
OTHER AREAS		NO SCREEN Area of Minimal Flood Hazard Zone X
		Effective LOMRs
		Area of Undetermined Flood Hazard Zone D
GENERAL STRUCTURES		Channel, Culvert, or Storm Sewer
		Levee, Dike, or Floodwall
OTHER FEATURES		Cross Sections with 1% Annual Chance Water Surface Elevation
		Coastal Transect
		Base Flood Elevation Line (BFE)
		Limit of Study
		Jurisdiction Boundary
		Coastal Transect Baseline
		Profile Baseline
	Hydrographic Feature	
MAP PANELS		Digital Data Available
		No Digital Data Available
		Unmapped

The pin displayed on the map is an approximate point selected by the user and does not represent an authoritative property location.

This map complies with FEMA's standards for the use of digital flood maps if it is not void as described below. The basemap shown complies with FEMA's basemap accuracy standards

The flood hazard information is derived directly from the authoritative NFHL web services provided by FEMA. This map was exported on 3/3/2021 at 12:31 PM and does not reflect changes or amendments subsequent to this date and time. The NFHL and effective information may change or become superseded by new data over time.

This map image is void if the one or more of the following map elements do not appear: basemap imagery, flood zone labels, legend, scale bar, map creation date, community identifiers, FIRM panel number, and FIRM effective date. Map images for unmapped and unmodernized areas cannot be used for regulatory purposes.

**FIGURE 3**  
Riverwalk  
Peabody, MA  
FEMA Map

APPENDIX D  
SPECS

SECTION 01562

DUST CONTROL

PART 1 - GENERAL

1.01 DESCRIPTION:

This section of the specification covers the control of dust via water, complete.

PART 2 - PRODUCTS

2.01 WATER:

- A. Water shall not be brackish and shall be free from oil, acid, and injurious alkali or vegetable matter.

PART 3 - EXECUTION

3.01 APPLICATION:

- A. Water may be sprinkler applied with equipment including a tank with gauge-equipped pressure pump and a nozzle-equipped spray bar.
- B. Water shall be dispersed through the nozzle under a minimum pressure of 20 pounds per square inch, gauge pressure.

END OF SECTION

\\wse03.local\WSE\Projects\MA\Peabody MA\MVP Action Grant 2019\Task 3 - Permitting\X - joint appendices\Appendix D - Specs\SECTION 01562-Dust Control.docx

## SECTION 01570

### ENVIRONMENTAL PROTECTION

#### PART 1 – GENERAL

##### 1.01 DESCRIPTION:

- A. The work covered by this section of the specifications consists of furnishing all labor, materials, tools and equipment and performing all work required for the prevention of environmental pollution during and as a result of construction operations under this contract.
- B. The requirements set forth in this section of the specifications apply to construction in and adjacent to wetlands, unless otherwise specifically stated.
- C. All work under this Contract shall be in accordance with the Conservation Commissions' Orders of Conditions as well as any conditional requirements applied
- D. Prior to commencement of work, the Contractor shall meet with representatives of the Engineer to develop mutual understandings relative to compliance of the environmental protection program.

##### 1.02 SUBMITTALS:

- A. The Contractor shall submit for approval six sets of details and literature fully describing environmental protection methods to be employed in carrying out construction activities within 100 feet of wetlands or across areas designated as wetlands.

#### PART 2 - PRODUCTS

##### 2.01 CATCH BASIN PROTECTION:

- A. To trap sediment and to prevent sediment from clogging drainage systems, catch basin protection in the form of a siltation sack (Siltsack as manufactured by ACF Environmental, Inc. or approved equal) shall be provided as approved by the Engineer.

##### 2.02 COMPOST FILTER TUBES:

- A. Silt socks shall be a tubular filter sock of mesh fabric. The fabric will have openings of between 1/8" to 1/4" diameter. The mesh material will either photo degrade within one year or be made of nylon with a life expectancy of 24 months. The sock shall be filled with a mix of composted leaf mulch, bark mulch and wood chips that have been composted for at least one year. The sock will have a minimum diameter of 12-inches.

### 2.03 EROSION CONTROL BLANKET:

- A. The erosion control blanket shall be completely biodegradable and constructed from spun jute yarns. The standard roll shall be 4' wide by 225' long and shall last approximately 6-9 months. The jute matting shall meet the following specifications.
- |                             |                           |
|-----------------------------|---------------------------|
| a. Mesh Size                | 11mm x 18mm               |
| b. Water Absorption         | >450% of Fabric Weight    |
| c. Thickness                | 0.25 inch                 |
| d. Recommended Shear Stress | 0.45 lbs./ft <sup>2</sup> |
| e. Recommended Flow         | 6 fps                     |
| f. Recommended Slope        | 3:1                       |
| g. Coverage                 | 100yd <sup>2</sup> /roll  |
| h. Roll Weight              | 92 lbs                    |
- B. Erosion control blanket shall be Jute Matting, manufactured by GEI Works, PO Box 780928, Sebastian, FL 32978, 772-646-0597, [www.geiworks.com](http://www.geiworks.com)

### 2.04 SILT CURTAIN:

- A. The silt curtain shall be a Type-1-Silt-Barrier consisting of 18-ounce vinyl fabric skirt with a 6-inch marine quality floatation device. The skirt shall be ballasted to hang vertical in the water column by a minimum 3/16-inch galvanized chain. The silt curtain shall extend into the water as shown on the drawings. If necessary, join adjacent ends of the silt curtain by connecting the reinforcing grommets and shackling ballast lines.

## PART 3- EXECUTION

### 3.01 NOTIFICATION AND STOPPAGE OF WORK:

- A. The Engineer will notify the Contractor in writing of any non-compliance with the provisions of the Order of Conditions. The Contractor shall, after receipt of such notice, immediately take corrective action. Such notice, when delivered to the Contractor or his authorized representative at the site of the work, shall be deemed sufficient for the purpose. If the Contractor fails to act promptly, the Owner may order stoppage of all or part of the work through the Engineer until satisfactory corrective action has been taken. No claim for an extension of time or for excess costs or damage incurred by the Contractor as a result of time lost due to any stop work orders shall be made unless it was later determined that the Contractor was in compliance.

### 3.02 AREA OF CONSTRUCTION ACTIVITY:

- A. Insofar as possible, the Contractor shall confine his construction activities to those areas defined by the plans and specifications. All land resources within the project boundaries and outside the limits of permanent work performed under this contract shall be preserved in their present condition or be restored to a condition after completion of construction at least equal to that which existed prior to work under this contract.

### 3.03 PROTECTION OF WATER RESOURCES:



- A. The Contractor shall not pollute streams, lakes or reservoirs with fuels, oils, bitumens, calcium chloride, acids or other harmful materials. It is the Contractor's responsibility to comply with all applicable Federal, State, County and Municipal laws regarding pollution of rivers and streams.
- B. Special measures should be taken to insure against spillage of any pollutants into public waters.

#### 3.04 CONSTRUCTION IN AREAS DESIGNATED AS WETLANDS ON THE DRAWINGS:

- A. Insofar as possible, the Contractor shall make every effort to minimize disturbance within areas designated as wetlands or within 100-feet of wetland resource areas.
- B. The Contractor shall perform his work in such a way that these areas are left in the condition existing prior to construction.
- C. The elevations of areas designated as wetlands shall not be unduly disturbed by the Contractor's operations.

#### 3.05 PROTECTING AND MINIMIZING EXPOSED AREAS:

- A. The Contractor shall limit the area of land which is exposed and free from vegetation during construction. In areas where the period of exposure will be greater than two (2) months, temporary vegetation, mulching or other protective measures shall be provided as specified.
- B. The Contractor shall take account of the conditions of the soil where temporary cover crop will be used to insure that materials used for temporary vegetation are adaptive to the sediment control. Materials to be used for temporary vegetation shall be approved by the Engineer.

#### 3.06 LOCATION OF STORAGE AREAS:

- A. The location of the Contractor's storage areas for equipment and/or materials shall be upon cleared portions of the job site or areas to be cleared as a part of this project, and shall require written approval of the Engineer. Plans showing storage facilities for equipment and materials shall be submitted for approval of the Engineer.
- B. No excavated materials or materials used in backfill operations shall be deposited within a minimum distance of one hundred (100) feet of any watercourse or any drainage facility. Adequate measures for erosion and sediment control such as the placement of baled straw or line of straw wattles or compost filter tubes around the downstream perimeter of stockpiles shall be employed to protect any downstream areas from siltation.
- C. There shall be no storage of equipment or materials in areas designated as wetlands.

- D. The Engineer may designate a particular area or areas where the Contractor may store materials used in his operations.

### 3.07 PROTECTION OF LANDSCAPE:

- A. The Contractor shall not deface, injure, or destroy trees or shrubs nor remove or cut them without written authority from the Owner. No ropes, cables, or guys shall be fastened to or attached to any existing nearby trees for anchorages unless specifically authorized by the Engineer. Excavating machinery and cranes shall be of suitable type and be operated with care to prevent injury to trees which are not to be removed, particularly overhanging branches and limbs. The Contractor shall, in any event, be responsible for any damage resulting from such use.
- B. Branches, limbs, and roots shall not be cut except by permission of the Engineer. All cutting shall be smoothly and neatly done without splitting or crushing. When there is unavoidable injury to branches, limbs and trunks of trees, the injured portions shall be neatly trimmed and covered with an application of grafting wax or tree healing paint as directed.
- C. Where, in the opinion of the Engineer, trees may possibly be defaced, bruised, injured, or otherwise damaged by the Contractor's equipment or by his blasting or other operations, the Engineer may require the Contractor to adequately protect such trees by placing boards, planks, poles or fencing around them. Any trees or landscape feature scarred or damaged by the Contractor's equipment or operations shall be restored as nearly as possible to its original condition at the expense of the Contractor. The Engineer will decide what method of restoration shall be used, and whether damaged trees shall be treated and healed or removed and disposed of under the provisions of Section 02230, CLEARING AND GRUBBING.
- D. Cultivated hedges, shrubs, and plants which could be injured by the Contractor's operations shall be protected by suitable means or shall be dug up, balled and temporarily replanted and maintained. After construction operations have been substantially completed, they shall be replanted in their original positions and cared for until growth is re-established. If cultivated hedges, shrubs, and plants are injured to such a degree as to affect their growth or diminish their beauty or usefulness, they shall be replaced by items of a kind and quality at least equal to that existing at the start of the work.

### 3.08 CLEARING AND GRUBBING:

- A. The Contractor shall clear and grub only on the Owner's land or the Owner's easements, and only the area required for construction operations, as approved by the Engineer. Removal of mature trees (4 inches or greater DBH) will not be allowed on temporary easements.
- B. The Contractor shall not remove trees in the Owner's temporary easements without permission of the Engineer.

### 3.09 DISCHARGE OF DEWATERING OPERATIONS:

- A. Under no circumstances shall the Contractor discharge water to the areas designated as wetlands. When constructing in a wetlands area, the Contractor shall discharge water from dewatering operations directly to the nearest drainage system, stream, or waterway after filtering by an approved method.
- B. The pumped water shall be filtered through filter fabric and baled straw, a vegetative filter strip or a vegetated channel to trap sediment occurring as a result of the construction operations. The vegetated channel shall be constructed such that the discharge flow rate shall not exceed a velocity of more than 1 foot per second. Accumulated sediment shall be cleared from the channel periodically.

### 3.10 DUST CONTROL:

- A. During the progress of the work, the Contractor shall conduct his operations and maintain the area of his activities, including sweeping and sprinkling of streets as necessary, to minimize creation and dispersion of dust. If the Engineer decides it is necessary to use calcium chloride for more effective dust control, the Contractor shall furnish and spread the material, as directed. Calcium chloride shall be as specified under Section 01562, DUST CONTROL.
- B. Calcium Chloride shall not be used for dust control within a drainage basin or in the vicinity of any source of potable water.

### 3.15 CATCH BASIN PROTECTION:

- A. Catch basin protection shall be used for every catch basin, shown on the plans or as required by the Engineer, to trap sediment and prevent it from clogging drainage systems and entering wetlands. Siltation sacks shall be securely installed under the catch basin grate. Care shall be taken to keep the siltation sacks from breaking apart or clogging. All deposited sediment shall be removed periodically and at times prior to predicted precipitation to allow free drainage flow. Prior to working in areas where catch basins are to be protected, each catch basin sump shall be cleaned of all debris and protected. The Contractor shall properly dispose of all debris at no additional cost to the Owner.

### 3.16 COMPOST FILTER TUBES:

- A. The filter tubes will be staked in the ground using wooden stakes driven at 4-foot intervals. The wooden stakes will be placed at a minimum depth of 24-inches into the ground.

### 3.17 EROSION CONTROL BLANKET:

- A. Mating rolls should be stored in their original, unopened packaging. The designated storage area should be level, dry, well-drained, stable, and should protect the product

- from precipitation, chemicals, standing water, excessive heat, ultraviolet radiation, vandalism, and animals.
- B. It is recommended that weed affected areas are sprayed with herbicide prior to mat installation. Excavate and trim slope to smooth profile, removing obstructions such as tree stumps or rubble and filling in any voids. Excavate anchor trenches along the top edge of the slope. Top soil is required to successfully grow grass and plants. Evenly spread top soil across the surface to required depth. All pre-seeding of the soil to be carried out prior to laying mat.
  - C. Dig a trench at the top of the slope, minimum depth of six (6) inches. Pin the end of the roll into the bottom of the trench. Back-fill the trench and roll the matting down the slope with a minimum overlap of four (4) inches.
  - D. See contract drawings for additional detail.

3.18 SILT CURTAIN:

- A. The silt curtain shall be a Type-1-Silt-Barrier consisting of 18-ounce vinyl fabric skirt with a 6-inch marine quality floatation device. The skirt shall be ballasted to hang vertical in the water column by a minimum 3/16-inch galvanized chain. The silt curtain shall extend into the water as shown on the drawings. If necessary, join adjacent ends of the silt curtain by connecting the reinforcing grommets and shackling ballast lines.

END OF SECTION

\\Wse03.local\WSE\Projects\MA\Peabody MA\MVP Action Grant 2019\Task 3 - Permitting\X - joint appendices\Appendix D - Specs\SECTION 01570 - Environmental Protection HIGGINS UPDATES.docx

## SECTION 01740

### CLEANING UP

#### PART 1 - GENERAL

##### 1.01 DESCRIPTION:

The Contractor must employ at all times during the progress of its work adequate cleanup measures and safety precautions to prevent injuries to persons or damage to property. The Contractor shall immediately, upon request by the Engineer provide adequate material, equipment and labor to cleanup and make safe any and all areas deemed necessary by the Engineer.

#### PART 2 - PRODUCTS

Not applicable

#### PART 3 - EXECUTION

##### 3.01 DAILY CLEANUP:

- A. The Contractor shall clean up, at least daily, all refuse, rubbish, scrap and surplus material, debris and unneeded construction equipment resulting from the construction operations and sweep the area. The site of the work and the adjacent areas affected thereby shall at all times present a neat, orderly and workmanlike appearance.
- B. Upon written notification by the Engineer, the Contractor shall within 24 hours clean up those areas, which in the Engineer's opinion are in violation of this section and the above referenced sections of the specifications.
- C. If in the opinion of the Engineer, the referenced areas are not satisfactorily cleaned up, all other work on the project shall stop until the cleanup is satisfactory.

##### 3.02 MATERIAL OR DEBRIS IN DRAINAGE FACILITIES:

- A. Where material or debris has washed or flowed into or has been placed in existing watercourses, ditches, gutters, drains, pipes, structures, such material or debris shall be entirely removed and satisfactorily disposed of during progress of the work, and the ditches, channels, drains, pipes, structures, and work shall, upon completion of the work, be left in a clean and neat condition.

##### 3.03 REMOVAL OF TEMPORARY BUILDINGS, STRUCTURES AND EQUIPMENT:

- A. On or before completion of the work, the Contractor shall, unless otherwise specifically required or permitted in writing, tear down and remove all temporary buildings and structures it built; shall remove all temporary works, tools and machinery or other construction

equipment it furnished; shall remove all rubbish from any grounds which it has occupied; shall remove erosion controls; and shall leave the roads and all parts of the property and adjacent property affected by its operations in a neat and satisfactory condition.

3.04 RESTORATION OF DAMAGED PROPERTY:

- A. The Contractor shall restore or replace, when and as required, any property damaged by its work, equipment or employees, to a condition at least equal to that existing immediately prior to the beginning of operations. To this end the Contractor shall do as required all necessary highway or driveway, walk and landscaping work. Materials, equipment, and methods for such restoration shall be as approved by the Engineer.

3.05 FINAL CLEANUP:

- A. Before acceptance by the Owner, the Contractor shall perform a final cleanup to bring the construction site to its original or specified condition. This cleanup shall include removing all trash and debris off of the premises. Before acceptance, the Engineer shall approve the condition of the site.

END OF SECTION

\\Wse03.local\WSE\Projects\MA\Peabody MA\MVP Action Grant 2019\Task 3 - Permitting\X - joint appendices\Appendix D - Specs\SECTION 01740-Cleaning Up.docx

APPENDIX E  
WETLANDS MEMO



# Wetland Delineation Report

April 2021

Peabody, Massachusetts  
Project # ENG20-0145

MVP Riverwalk  
Peabody, MA

Wetland Delineation Conducted By:  
Nathaniel Parker on 4/1/2021

Delineation Report Reviewed By:  
Mel Higgins, PWS



## TABLE OF CONTENTS

	Page
1.0 SITE DESCRIPTION .....	1-1
2.0 DELINEATION OF WETLAND RESOURCES .....	2-1
2.1 Site Observations .....	2-1
2.2 Bank .....	2-1
2.3 Other Protected Areas .....	2-2
3.0 SUMMARY .....	3-1
4.0 REFERENCES .....	4-1

## FIGURES

Figure 1 .....	Wetlands Field Map
Figure 2 .....	USGS Topographic Map
Figure 3 .....	FEMA FIRM Map
Figure 4 .....	Environmental Resources Map

## APPENDICES

Appendix A .....	Site Photographs
------------------	------------------

## 1.0 SITE DESCRIPTION

On April 1st, 2021, the presence of wetland resources was investigated near Proctor Brook in Peabody, MA. This investigation area is located in a predominantly urban/industrial area. Please see Figure 1 (Wetlands Field Map) and Figure 2 (USGS Topographic Map) of this report for the investigation area.

Wetland resource areas including a perennial stream were identified and flagged in the field using pink flagging by a Weston & Sampson employee who is trained in the wetland delineation process using the Massachusetts Department of Environmental Protection (MassDEP) and the US Army Corps of Engineers methodology. A further description of these wetland resource areas is presented in the following sections.

## 2.0 DELINEATION OF WETLAND RESOURCES

### 2.1 Site Observations

The Weston & Sampson wetland scientist, trained in the ACOE Wetland Delineation Manual and Massachusetts Department of Environmental Protection (MassDEP) Delineating Bordering Vegetated Wetlands Under the Massachusetts Wetland Protection Act guidance document, observed the following protected wetland resources at the site:

- Bank – Perennial Stream

Field data were recorded on US Army Corps of Engineers (ACOE) Wetland Determination Data Forms. See Appendix A for site photographs.

### 2.2 Bank

Water bodies, including perennial streams, intermittent streams, ponds and lakes, have banks which are protected by the Massachusetts Wetland Protection Act. Bank is a wetland resource area defined by 310 CMR 10.54(2)(a) as “the portion of land surface which normally abuts and confines a water body. It occurs between a waterbody and a vegetated bordering wetland and adjacent floodplain, or, in absence of these, it occurs between a waterbody and an upland.” Vegetated banks provide valuable functions such as flood control, stormwater prevention, fisheries protection, and water quality protection. The limit of this resource area is identified by Top of Bank (TOB) which is located at the first observable break in slope or the Mean Annual Flood Level (MAFL), whichever is lower. TOB is easily identified in the field so that indicator was utilized for this wetland delineation.

#### Perennial Stream Banks

A single perennial stream known as Proctor Brook was identified within the investigation area. The boundary of the perennial stream was identified in the field utilizing Top of Bank (TOB), identified by flag line TOB-A. Proctor Brook is shown as perennial on the current United States Geographical Survey (USGS) map and has a watershed size greater than 0.5 square miles in size according to USGS Stream Stats which classifies the stream as perennial per 310 CMR 10.58 (2)(a)(1)(b-c). The boundary of the

perennial stream was identified in the field by the first observable break in slope (TOB). Wetland flags left in the field included:

- TOB-A1 through TOB-A23 (Perennial Stream Bank "A" Series)

Perennial streams are subject to a 200-foot Riverfront Area under the Massachusetts Wetland Protection Act per 301 CMR 10.58(2)(a)(2)(c).

### 2.3 Other Protected Areas

Weston & Sampson created environmental resources maps (see Figure 4) of the site to determine the presence of other protected areas. The data source of these map layers was the Massachusetts Geographic Information System (MassGIS). These areas included:

- NHESP Priority Habitats of Rare Species
- NHESP Estimated Habitats of Rare Wildlife
- NHESP Certified and Potential Vernal Pools
- Areas of Critical Environmental Concern (ACEC)
- Outstanding Resource Waters (ORW)

Wetland resources identified in the field were also added to these maps. Based on the MassGIS information there are no protected areas other than the Perennial Stream resource area previously identified above.

Based on the information provided by the FIRM map the investigational area is located within a Regulatory Floodway. FEMA defines a Regulatory Floodway as "the channel of a river or other watercourse and the adjacent land areas that must be reserved in order to discharge the base flood without cumulatively increasing the water surface elevation more than a designated height." This Regulatory Floodway is located within Zone AE, which is the 100-year flood zone. As a result, the investigation is located within the 100-year flood zone.

## 3.0 SUMMARY

On April 1<sup>st</sup> 2021, the presence of wetland resources was investigated near Proctor Brook in Peabody, MA. A single perennial stream was identified and flagged at the site.

Additional environmental mapping was conducted using MassGIS data layers and FEMA FIRM mapping. This additional mapping indicates that the investigation area falls within the 100-year floodzone.

This Wetlands Delineation Report has been reviewed and approved by a Professional Wetland Scientist PWS.

---

#### 4.0 REFERENCES

- Jackson, Scott. 1995. "Delineating Bordering Vegetated Wetlands Under the Massachusetts Wetlands Protection Act." Massachusetts Department of Environmental Protection.
- Massachusetts Division of Fisheries and Wildlife, Natural Heritage and Endangered Species Program. Massachusetts Natural Heritage Atlas, 13th Edition with 2017 web updates. Accessed on 4/5/2021
- Massachusetts Geographic Information System. January 2009. Outstanding Resource Waters. Massachusetts Department of Environmental Protection. Accessed on 4/5/2021
- Massachusetts Geographic Information System. December 2003. Areas of Critical Environmental Concern. Massachusetts Department of Environmental Protection. Accessed on 4/5/2021
- Newcomb, Lawrence. 1977. Newcomb's Wildflower Guide. Little, Brown and Company.
- Web Soil Survey of Essex County, Massachusetts. United States Department of Agriculture, Soil Conservation Service, in cooperation with Massachusetts Agricultural Experiment Station
- United States Department of Agriculture, Natural Resources Conservation Service. 2018. *Field Indicators of Hydric Soils in the United States, Version 8.2*. L. M. Vasilas, G. W. Hurt, and J.F. Berkowitz (eds.). USDA, NRCS, in cooperation with the National Technical Committee for Hydric Soils.
- USACOE, January 1987, Corps of Engineers Wetlands Delineation Manual, Wetlands Research Program Technical Report Y-87-1.
- FEMA Flood Map Service Center, online at [msc.fema.gov/portal](https://msc.fema.gov/portal) Assessed on 4/5/2021
- Tiner, Jr., Ralph W., 2005, Field Guide to Nontidal Wetland Identification
- Tiner, Jr., Ralph W, 2009, Field Guide to Tidal Wetland Plants of the Northeastern United States and Neighboring Canada.
- Wojtec, Michael, Bard – A field Guide to Trees of the Northeast.
- New England Hydric Soils Technical Committee, 2019, Version 4, *Field Indicator of Identifying Hydric Soils in New England*. New England Interstate Water Pollution Control Commission, Lowell, MA.





**Legend**

-  Perennial Stream
-  Investigation Area
-  Marsh/Bog
-  Wooded marsh
-  Cranberry Bog
-  Salt Marsh
-  Open Water
-  Reservoir (with PWSID)
-  Tidal Flats
-  Beach/Dune

**FIGURE 1**

MVP Riverwalk  
Peabody, MA

Wetland Field Map

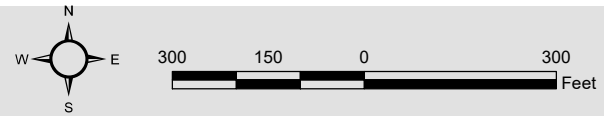

Data Source: Office of Geographic and Environmental Information (MassGIS),  
Commonwealth of Massachusetts Executive Office of Environmental Affairs





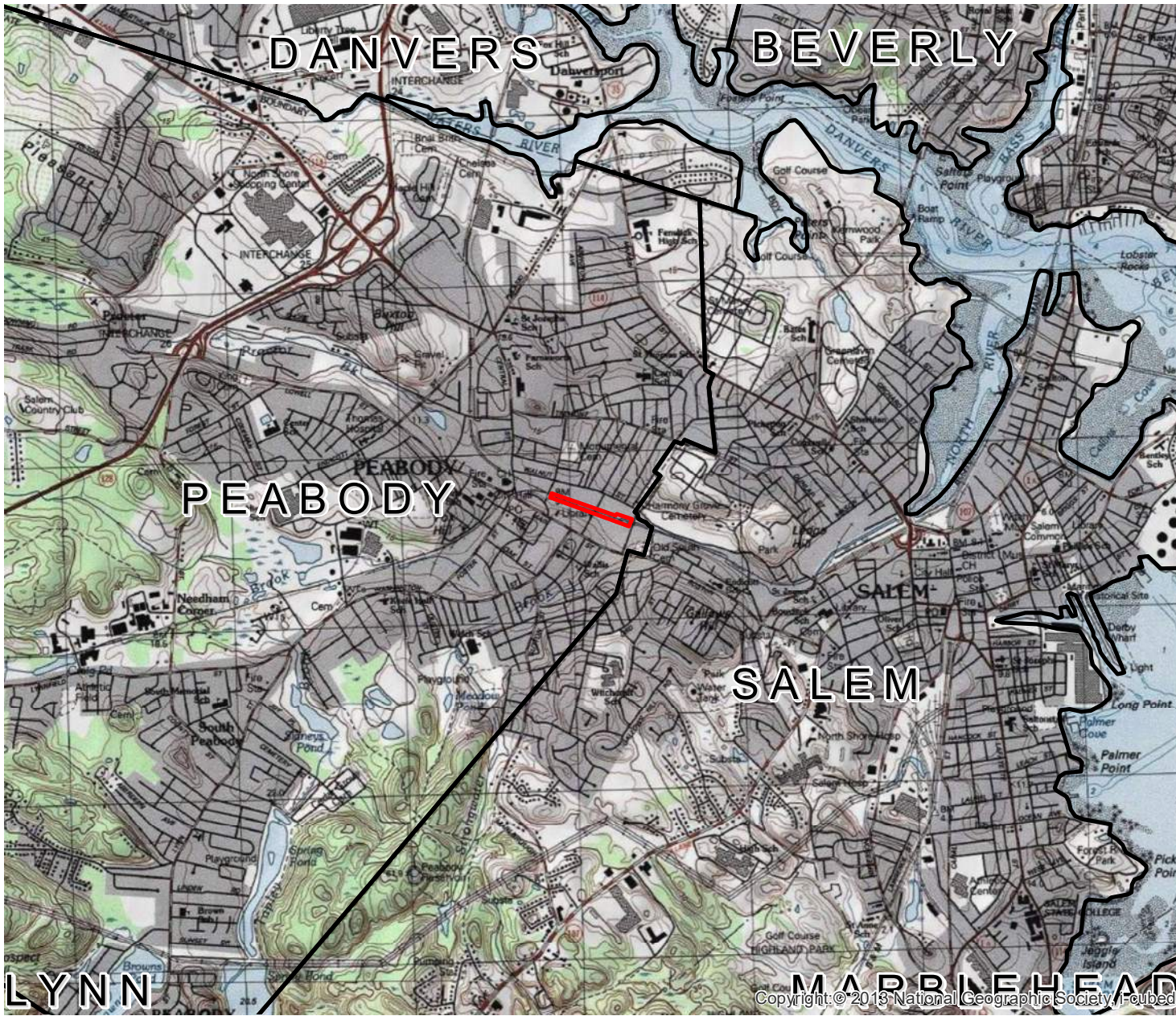

**Legend**

 Investigation Area

**FIGURE 2**

MVP Riverwalk  
Peabody, MA

Locus Map

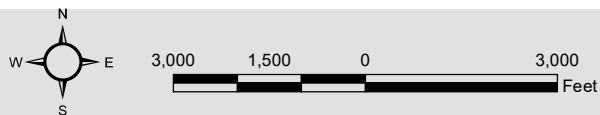





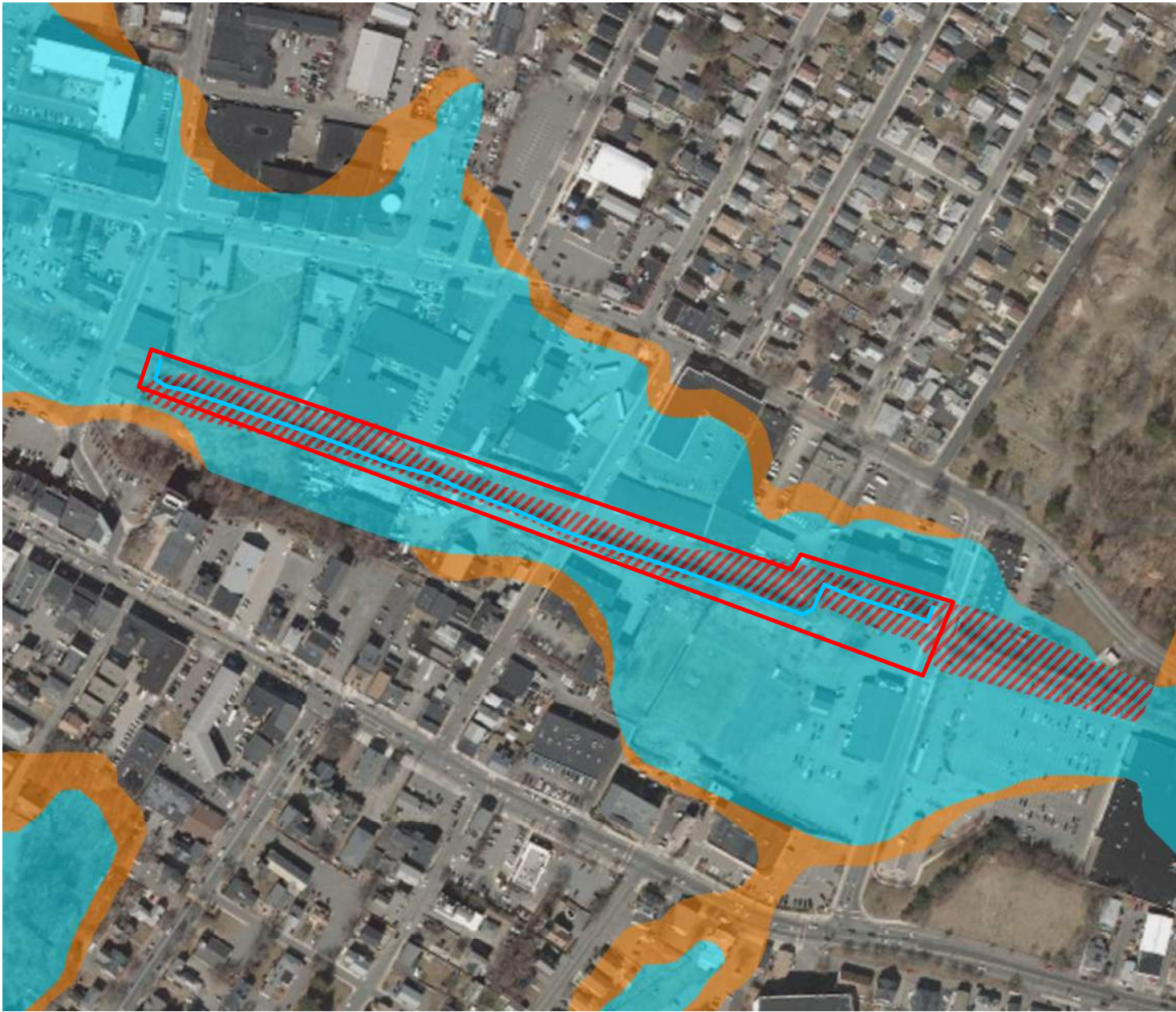







Data Source: Office of Geographic and Environmental Information (MassGIS),  
Commonwealth of Massachusetts Executive Office of Environmental Affairs





**Legend**

-  Perennial Stream
-  Investigation Area
- FEMA National Flood Hazard Layer**
- Flood Zone Designations**
-  A: 1% Annual Chance of Flooding, no BFE
-  AE: 1% Annual Chance of Flooding, with BFE
-  AE: Regulatory Floodway
-  AH: 1% Annual Chance of 1-3ft Ponding, with BFE
-  AO: 1% Annual Chance of 1-3ft Sheet Flow Flooding, with Depth
-  VE: High Risk Coastal Area
-  D: Possible But Undetermined Hazard
-  X: 0.2% Annual Chance of Flooding
-  X: Reduced Flood Risk due to Levee
-  Area Not Included
-  Area with no DFIRM - Paper FIRMs in Effect

**FIGURE 3**

MVP Riverwalk  
Peabody, MA

FEMA Map

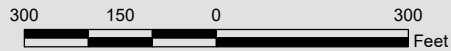
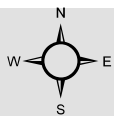









Data Source: Office of Geographic and Environmental Information (MassGIS),  
Commonwealth of Massachusetts Executive Office of Environmental Affairs







**Legend**

-  Perennial Stream
-  Investigation Area
- ACECs**
-  ACECs
- NHESP Habitats**
-  NHESP Estimated Habitats of Rare Wildlife
-  NHESP Priority Habitats of Rare Species
-  NHESP Certified Vernal Pools
-  NHESP Potential Vernal Pools
- Outstanding Resource Waters**
-  Public Water Supply Contributor
-  ORW for ACEC
-  ORW for both Water Supply and Other

**FIGURE 4**

MVP Riverwalk  
Peabody, MA

Environmental  
Resource Map

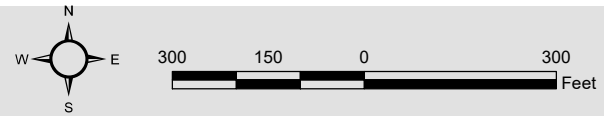

Data Source: Office of Geographic and Environmental Information (MassGIS),  
Commonwealth of Massachusetts Executive Office of Environmental Affairs



## APPENDIX A

### Site Photographs





Photo 1: Proctor Brook



APPENDIX F  
PHOTOS

Riverwalk  
Peabody, MA





Riverwalk  
Peabody, MA



APPENDIX G  
DISTRIBUTION LIST

**Peabody - MVP Riverwalk Project  
Army Corps of Engineers 404 Permit Distribution List**

U.S. Army Corps of Engineers  
Regulatory Division  
696 Virginia Road  
Concord, Massachusetts 01742-2751

National Marine Fisheries Service  
55 Great Republic Drive  
Gloucester, MA 01930

National Park Services  
15 State Street  
Boston, MA 02109

US Environmental Protection Agency  
5 Post Office Square  
Suite 100 (OEP05-2)  
Boston, MA 02109-3912

US Fish and Wildlife Service  
70 Commercial Street, Suite 300  
Concord, NH 03301

DEP Division of Wetlands and Waterways  
One Winter Street  
Boston, Massachusetts 02108

MassDEP Northeast Region Office  
Wetlands and Waterways  
205 Lowell Street  
Wilmington MA 01887

Massachusetts Office of Coastal Zone Management  
251 Causeway Street, Suite 800  
Boston, MA 02114

State Historic Preservation Officer (SHPO)  
Massachusetts Historical Commission (MHC)  
The Massachusetts Archives Bldg.  
220 Morrissey Boulevard  
Boston, Massachusetts 02125

Massachusetts Board of Underwater Archaeological Resources  
251 Causeway Street, Suite 800  
Boston, MA 02114

Wampanoag Tribal Historic Preservation Officer  
Wampanoag Tribe of Gay Head (Aquinnah)  
20 Black Brook Road  
Aquinnah, MA 02535

Tribal Historic Preservation Officer  
Mashpee Wampanoag Tribe  
483 Great Neck Road South  
Mashpee, MA 02649

Chief, Risk Analysis Branch  
FEMA Region 1  
U.S Department of Homeland Security  
99 High Street, 6th Floor  
Boston, MA 02110

APPENDIX H  
ABUTTER INFORMATION



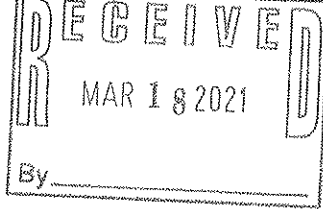

CERTIFICATION OF ABUTTERS

DATE: 3/17/2021

PROPERTY OWNER City of Peabody MAP: multiple LOT: multiple

PROPERTY LOCATION: Proctor Brook (see attached map)

REQUESTED BY: Alexandra Gaspar on behalf of the City of Peabody PHONE #: 978-548-4238

PLEASE ALLOW UP TO 5 BUSINESS DAYS FOR THE COMPLETION OF YOUR REQUEST

- Chapter 138, Section 15A - direct abutters & churches, synagogues, hospitals and schools within 500'
Chapter 40A, Section 11 - abutter to abutter within 300'
Special Permit Variance
Chapter 41, Section 81T - direct abutters
XXXX Chapter 32, City of Peabody Code - Wetlands & Rivers Protection Regulations
abutter to abutter within 300'
XXXX Chapter 131, Section 40 - abutters within 100' (MUST BE DONE AS ABOVE EFFECTIVE 4/01)

MAP/LOT

Multiple map/lots, "see attached map" for work area.

Thank you!!!!

86-142A

150

130X

150A

135

151X

136

155

137

162

138

600-647

140X

141

142

126-1

142B

143

Salem City Hall
93 Washington St
Salem, MA 01970

144

145

149

BOARD OF ASSESSORS
CITY OF PEABODY
Susan E. Carmello
3/24/2021

CERTIFIED

### Work Area for Abutters List

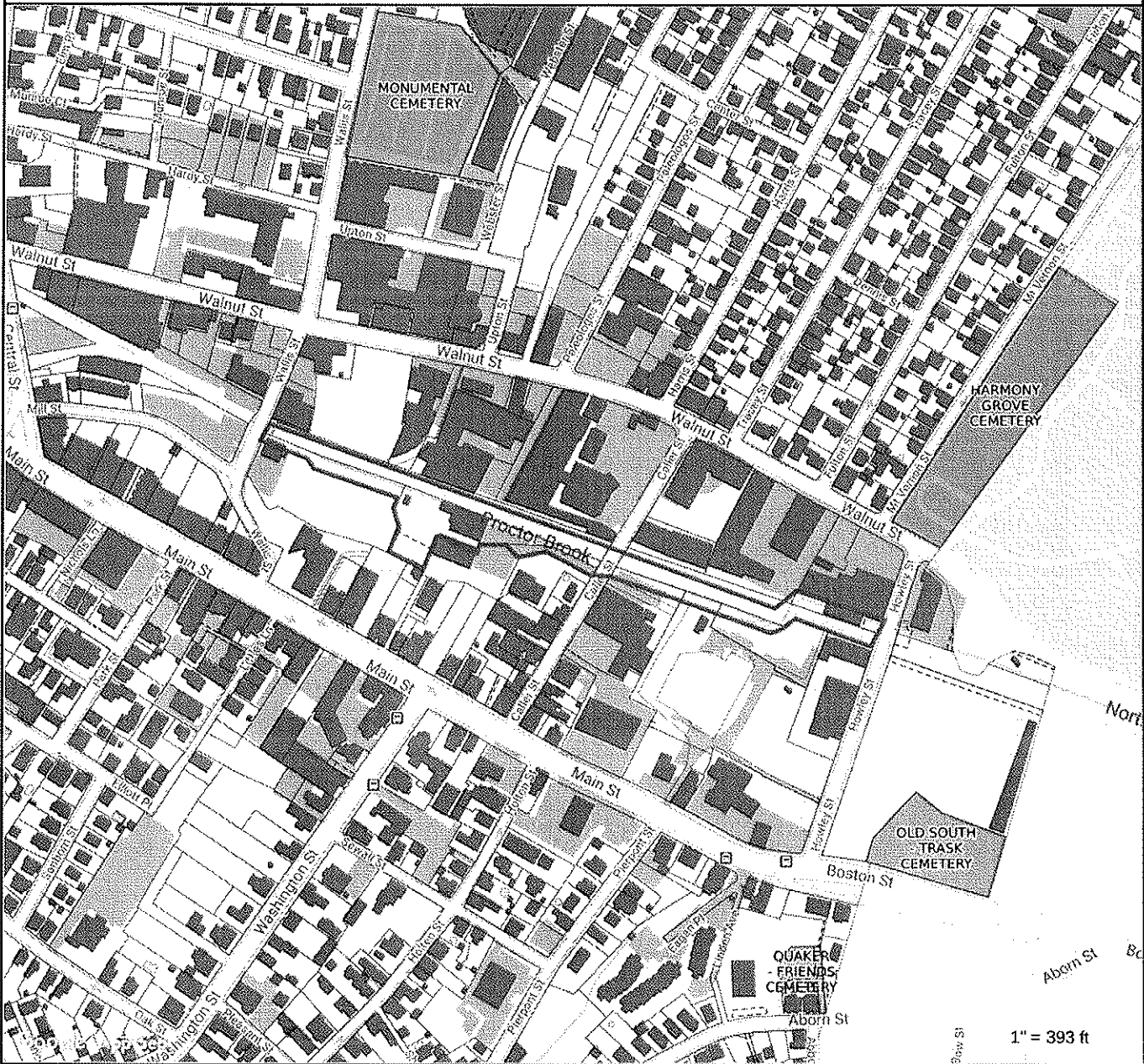

MAP FOR REFERENCE ONLY  
NOT A LEGAL DOCUMENT

City of Peabody, MA makes no claims and no warranties, expressed or implied, concerning the validity or accuracy of the GIS data presented on this map.

Geometry updated October 2020  
Data updated October 2020

Property ID	Owner	Owner 2	Owner Address	Owner Address 2
086-142A	CITY OF PEABODY		24 LOWELL ST	PEABODY, MA 01960
085-033	SKOURAS WILLIAM J TRUSTEE	W J SKOURAS REALTY TRUST	170 REAR LYNN ST	PEABODY, MA 01960
085-034	SKOURAS WILLIAM J TRUSTEE	W J SKOURAS REALTY TRUST	13 MASON ST	PEABODY, MA 01960
085-035	PETRADELIS JOHN TRUSTEE	PETRADELIS REALTY TRUST	3 NEWTON DR	PEABODY, MA 01960
085-036	DESALVO C/JW & DC TRUSTEES	C/O CENTURY TIRE	53 WALNUT ST	PEABODY, MA 01960
085-037	CITY OF PEABODY	PARK	24 LOWELL ST	PEABODY, MA 01960
085-038	AEGEAN HOLDINGS LLC	C/O ZION ALAN	P O BOX 246	LYNNFIELD, MA 01940
085-039X	ZION REALTY CORP		12 BUTTONWOOD LN	IPSWICH, MA 01938
085-041	PORTER E H CONSTRUCTION INC		P.O. BOX 708	PEABODY, MA 01960
085-041A	DIMAMBRO ALFRED JR TRUSTEE	REGENCY REALTY TRUST	P.O. BOX 708	PEABODY, MA 01960
085-042	CITY OF PEABODY		24 LOWELL ST	PEABODY, MA 01960
085-043	BURNETT NORMAN S & DAVID S		PO BOX 409	PEABODY, MA 01960
085-072	CITY OF PEABODY	PEABODY INSTITUTE LIBRARY	24 LOWELL ST	PEABODY, MA 01960
085-072B	VALERA JUAN & THERESA		2 APPLETON ST	LYNN, MA 01902
085-073	KNIGHTS OF COLUMBUS		96 MAIN ST	PEABODY, MA 01960
085-075	A & A PROPERTIES LLC		98 MAIN ST	PEABODY, MA 01960
085-075A	MACDONALD WILLIAM S & TRACEYE E		98 MAIN ST (R)	PEABODY, MA 01960
085-076	100R MAIN LLC		78 MILL ST	MIDDLETON, MA 01949
085-077	PHU JASON T & JUDY		22 SYMONDS ST	SALEM, MA 01970
085-078	KEVRAY 108 MAIN LLC		106 MAIN ST	PEABODY, MA 01960
085-079	KEVRAY 108 MAIN LLC		106 MAIN ST	PEABODY, MA 01960
085-080	116 MAIN STREET LLC		P.O. BOX 365	EAST HAMPSTEAD, NH 03826
085-082	BERUBE JOHN T & LENA L TRS	BERUBE PEABODY MAIN RLTY TRST	66 COUNTY WAY EXT	BEVERLY, MA 01915
085-083	KOKORAS NICHOLAS & GEORGE TRS	CALLER STREET TRUST	80 WASHINGTON ST - APT 1B	PEABODY, MA 01960
086-130X	PEABODY RA LLC	C/O WINSTANLEY ENTERPRISES LLC	150 BAKER AVE EXT - SUITE 303	CONCORD, MA 01742
086-135	MERLINA A J & A B TRUSTEES	A & A HOWLEY ST REALTY TRUST	27 HOWLEY ST	PEABODY, MA 01960
086-136	FLOMP PATRICIA TRUSTEE	26 HOWLEY STREET TRUST	50 BROAD STREET	SALEM, MA 01970
086-137	FLOMP PATRICIA TRUSTEE	26 HOWLEY STREET TRUST	50 BROAD STREET	SALEM, MA 01970
086-138	77 WALNUT STREET LLC		300 ANDOVER ST -SUITE 372	PEABODY, MA 01960
086-140X	119 REAR FOSTER STREET LLC		PO BOX 606	PEABODY, MA 01960
086-141	27 CALLER STREET LLC		120 HARVARD ST	MALDEN, MA 02148
086-142	BOSTON CHIMNEY & TOWER CO INC		P O BOX 272	PEABODY, MA 01960
086-142B	E VICTORY PROPERTIES LLC		3 HICKORY LN	TOPSFIELD, MA 01983
086-143	BOSTON CHIMNEY & TOWER CO INC		P O BOX 272	PEABODY, MA 01960
086-144	KOKORAS GEORGE & NICHOLAS TRUSTEES	CALLER STREET TRUST	80 WASHINGTON ST - APT 1B	PEABODY, MA 01960
086-145	KOKORAS NICHOLAS & GEORGE TRS	CALLER STREET TRUST	80 WASHINGTON ST - APT 1B	PEABODY, MA 01960
086-149	KOKORAS NICHOLAS & GEORGE TRS	CALLER STREET TRUST	80 WASHINGTON ST - APT 1B	PEABODY, MA 01960
086-150	AZOREAN BROTHERHOOD OF THE	DIVINE HOLY GHOST INC	20 HOWLEY ST	PEABODY, MA 01960
086-150A	RIVERWALK PLACE LLC	C/O BIBBY REAL ESTATE CORP	PO BOX 110	LYNN, MA 01903
086-151X	RIVER DEVELOPMENT LLC		21 CALLER ST - SUITE 1	PEABODY, MA 01960
086-155	PATEL MAHAVIR & ARVIND TRUSTEES	KARM REALTY TRUST II	42 STILLMAN RD	LYNNFIELD, MA 01940
086-162	THE AZOREAN BROTHERHOOD OF THE	DIVINE HOLY GHOST INC C/O PINTO MARIO	11 HINGSTON ST	PEABODY, MA 01960
086-600	S & PO REALTY LLC		116 RANTOUL ST - #301	BEVERLY, MA 01915
086-601	PITZI JENNIFER L & MARK	JOHANSSON JOSEPH	118 SYLVAN ST	DANVERS, MA 01923
086-602	GRIECO MATTHEW C & MELISSA L		14 WYMON WAY	LYNNFIELD, MA 01940
086-603	PIKE CONNOR SCOTT		75 WALNUT ST - UNIT 104	PEABODY, MA 01960
086-604	JCG INVESTMENTS LLC		1 CENTRAL ST - SUITE 203	MIDDLETON, MA 01949
086-605	KOLA IRENE & ALEKSANDER		61 CASTLE CIR	PEABODY, MA 01960
086-606	SNYDER GLENN		75 WALNUT ST - UNIT 107	PEABODY, MA 01960

1072

Property ID	Owner	Owner 2	Owner Address	Owner Address 2
086-607	GACEVIC ADIS		75 WALNUT ST - UNIT 108	PEABODY, MA 01960
086-608	BODINAKU ROVENA		177 MAIN ST - UNIT C	PEABODY, MA 01960
086-609	AMORIM JOSE M		75 WALNUT ST - UNIT 110	PEABODY, MA 01960
086-610	CAIN EDWARD MICHAEL		75 WALNUT ST - UNIT 111	PEABODY, MA 01960
086-611	BRACE MORGAN THOMPSON		75 WALNUT ST - UNIT 112	PEABODY, MA 01960
086-612	SILVA KATIA REGINA & MARTINS DJORGE	MARTINS GUILHERME	75 WALNUT ST - UNIT 113	PEABODY, MA 01960
086-613	PRASETIOWATI SUTJI		75 WALNUT ST - UNIT 114	PEABODY, MA 01960
086-614	LIMA GEORGE M & LISETE M		75 WALNUT ST UNIT - 115	PEABODY, MA 01960
086-615	FORBES KAREN M &	ELLIOTT JONATHAN E	2 MCDEWELL AVE - APT 16	DANVERS, MA 01923
086-616	MANCUSO NICHOLAS &	CULLITY COLLEEN	75 WALNUT ST - UNIT 201	PEABODY, MA 01960
086-617	ZUPPIO ANTHONY TRUSTEE	ZUPPIO FAMILY TRUST	75 WALNUT ST - UNIT 202	PEABODY, MA 01960
086-618	LOUANAS NOUREDDINE		75 WALNUT ST - UNIT 203	PEABODY, MA 01960
086-619	ZENG JIA XI & LIU YUCI		75 WALNUT ST - UNIT 204	PEABODY, MA 01960
086-620	KIPE SHPRESA & PAMELA		75 WALNUT ST - UNIT 205	PEABODY, MA 01960
086-621	GRIECO MATTHEW C & MELISSA L		14 WYMON WAY	LYNNFIELD, MA 01940
086-622	GIUFFRIDA CASSANDRA		14 DOANE AVE	BEVERLY, MA 01915
086-623	MCLAUGHLIN CHERYL		75 WALNUT ST - UNIT 208	PEABODY, MA 01960
086-624	COLLINS MARK S		37 LEDGEMONT LN	LYNN, MA 01904
086-625	HADSALL WILLIAM S		75 WALNUT ST - UNIT 210	PEABODY, MA 01960
086-626	NAKO ROBERT		119 ELLIOTT ST	DANVERS, MA 01923
086-627	KUDZMA MARGARET		75 WALNUT ST - UNIT 212	PEABODY, MA 01960
086-628	BABIC SEMSUDIN & EMINA		75 WALNUT ST - UNIT 213	PEABODY, MA 01960
086-629	YORK IRENE COTONI		75 WALNUT ST - UNIT 214	PEABODY, MA 01960
086-630	JAWORSKI BARBARA C		75 WALNUT ST UNIT 215	PEABODY, MA 01960
086-631	DE OLIVEIRA CARLOS &	DE OLIVEIRA RITA DE CASSIA	75 WALNUT ST -UNIT 216	PEABODY, MA 01960
086-632	SOARES BRENT &	VIERA-CONTRERAS KATIUSKA	75 WALNUT ST UNIT 301	PEABODY, MA 01960
086-633	SANTANA SOLENNE B		75 WALNUT ST - UNIT 302	PEABODY, MA 01960
086-634	SANTIANO-MCHATTON KATHERINE		75 WALNUT ST -UNIT 303	PEABODY, MA 01960
086-635	UPTON MANOR APARTMENT LLC		5 LISA RD	PEABODY, MA 01960
086-636	BODINAKU ARTAN & VARVARA		75 WALNUT ST UNIT 305	PEABODY, MA 01960
086-637	ZHUGLI ERILDA & MUSTAFA		75 WALNUT ST - UNIT 306	PEABODY, MA 01960
086-638	BLANARU PATRICIA		75 WALNUT ST UNIT 307	PEABODY, MA 01960
086-639	MCCABE EDWARD T		75 WALNUT ST UNIT 308	PEABODY, MA 01960
086-640	SON HUISOOK JENI & SOK		75 WALNUT ST UNIT 309	PEABODY, MA 01960
086-641	BETTGER JONATHAN R &	BETTGER PATRICIA LAROCQUE	306 LONGHILL AVE	SOMERSET, MA 02726
086-642	FOURNIER BETH A		75 WALNUT ST - UNIT 311	PEABODY, MA 01960
086-643	RITTMULLER ROBERT J		75 WALNUT ST - UNIT 312	PEABODY, MA 01960
086-644	LITCHFIELD DAVID L	BARBOSA FREDERICK & MARIA	75 WALNUT ST UNIT 313	PEABODY, MA 01960
086-645	MEDICO CHRISTOPHER		75 WALNUT ST UNIT 314	PEABODY, MA 01960
086-646	JANIELIS HELEN M		75 WALNUT ST - UNIT 315	PEABODY, MA 01960
086-647	FOSS DAVID &	FOSS DANIEL	75 WALNUT ST UNIT 316	PEABODY, MA 01960
126-001	B & M RAILROAD (MBTA)	GUILFORD TRANSPORTATION IND INC	IRON HORSE PARK	NO BILLERICA, MA 01862
	SALEM CITY HALL		93 WASHINGTON ST	SALEM, MA 01970

*Joseph George*  
*SALEM, MA 01970*

2 of 2



# PEABODY RIVERWALK

## RIVERWALK PARK

WALLIS STREET - CALLER STREET - HOWLEY STREET,  
PEABODY, MA 01960

### SHEET INDEX

L001	COVER SHEET
L100 - L102	SITE INDEX PLAN
L110 - L112	EXISTING CONDITIONS PLAN
L120 - L122	SITE DEMOLITION AND PREPARATION PLAN
L130 - L132	MATERIALS PLAN
L130 - L132	LAYOUT PLAN
L140 - L142	GRADING AND DRAINAGE PLAN
L150 - L152	PLANTING PLAN
L500 - L504	CONSTRUCTION DETAILS
S200-S202	PROPOSED LAYOUT PLAN I - III
S600-S601	WALL SECTIONS AND DETAILS I - II
S602	OVERLOOK FRAMING PLAN, SECTIONS, & DETAILS
S603	TIMBER BRIDGE PLAN & TYP. SECTION
S604	TIMBER BRIDGE DETAILS
S605-S606	BOARDWALK PLAN & ELEVATION
S607	BOARDWALK TYP. SECTIONS
S608	BOARDWALK ABUTMENT TYP. SECTIONS
C601	EROSION AND SEDIMENT CONTROL DETAILS
E001	ELECTRICAL LEGEND, NOTES AND ABBREVIATIONS
E101 - E103	ELECTRICAL SITE PLAN A - C
E501	ELECTRICAL DETAILS
E601	ELECTRICAL RISER AND SCHEDULES

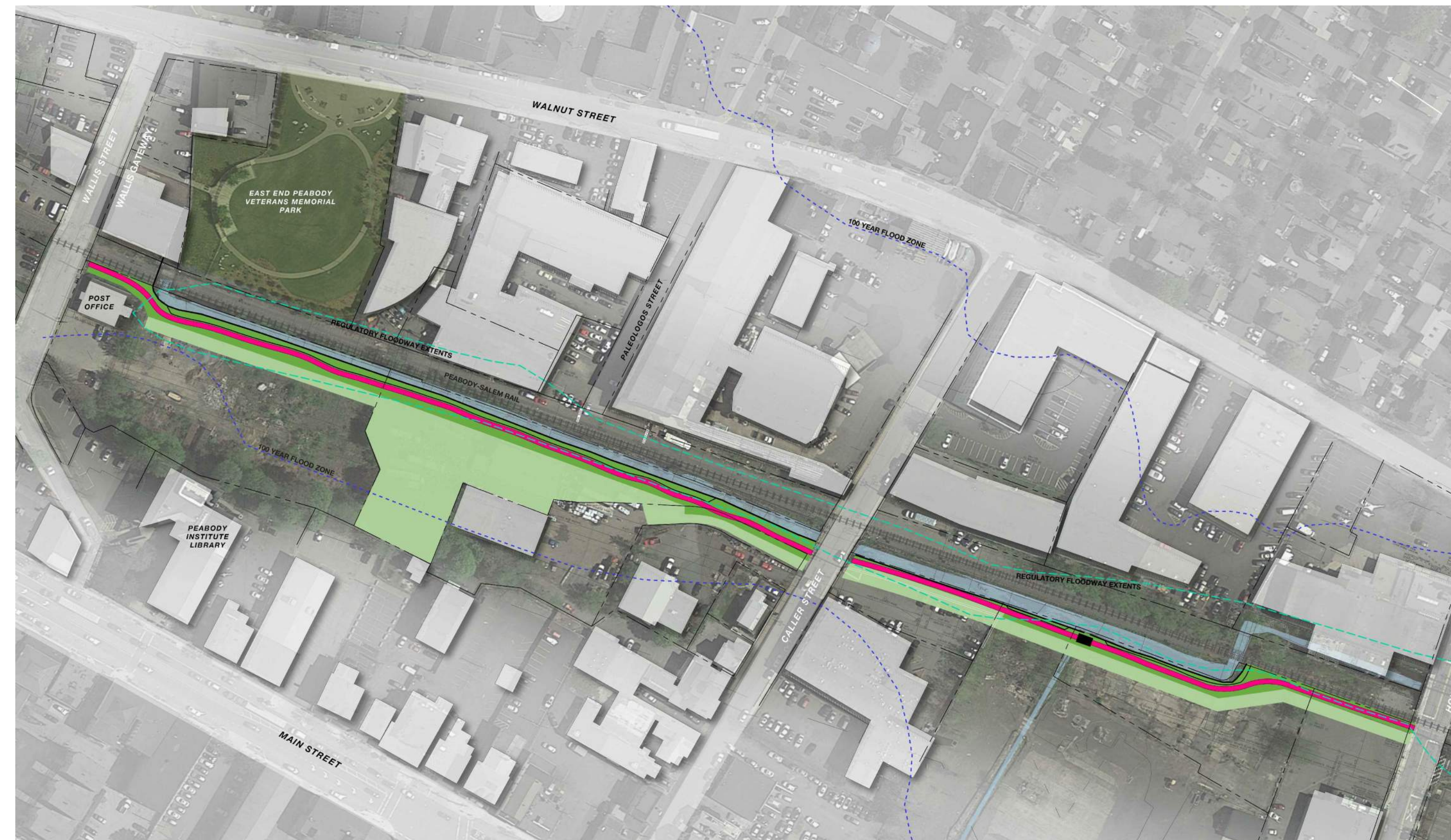

75% CONSTRUCTION DOCUMENTS  
-NOT FOR CONSTRUCTION-

APRIL 2021

### Locus Map

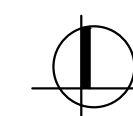

PEABODY RIVERWALK VICINITY MAP  
PEABODY, MA 01960

Prepared By

Weston & Sampson<sup>SM</sup>  
design studio

Weston & Sampson Engineers, inc.  
85 Devonshire St., 3rd Floor,  
Boston, MA 02109  
(617) 412-4480  
www.westonandsampson.com



**LEGEND**

- PROPERTY LINE
- LIMIT OF WORK
- EASEMENTS
- 100-FT WETLAND BUFFER
- 200-FT RIVERFRONT PROTECTION AREA
- APPROXIMATE LIMIT OF EXISTING 100-YEAR FLOOD PLAN

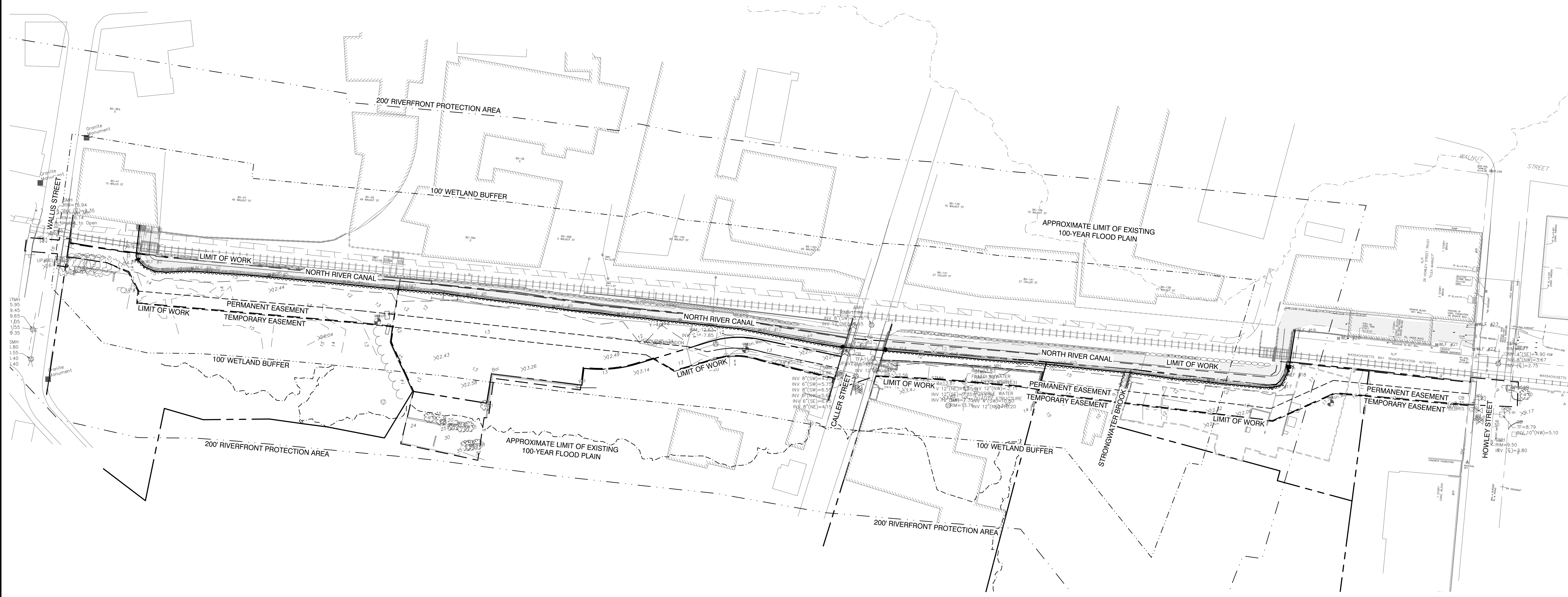

Project:  
**PEABODY RIVERWALK  
 RIVERWALK PARK**



WALLIS STREET -  
 CALLER STREET -  
 HOWLEY STREET  
 PEABODY, MA. 01960

**Weston & Sampson**  
 WESTON & SAMPSON ENGINEERS, INC.  
 85 DEVONSHIRE STREET, 3RD FLOOR  
 BOSTON, MA 02109  
 617-412-4480  
 www.westonandsampson.com

Consultants:

Revisions:

No.	Date	Description

Seal:

Key Plan:



Issued For:  
**75% CONSTRUCTION  
 DOCUMENTS  
 - NOT FOR CONSTRUCTION -**

Scale: 1" = 60'

Date: APRIL 2021  
 Drawn By: FD, TY, SG  
 Reviewed By: CC  
 Approved By: CFR

W&S Project No.: ENG20-0145  
 W&S File No.:

Drawing Title:  
**SITE INDEX PLAN**

Sheet Number:  
**L001**

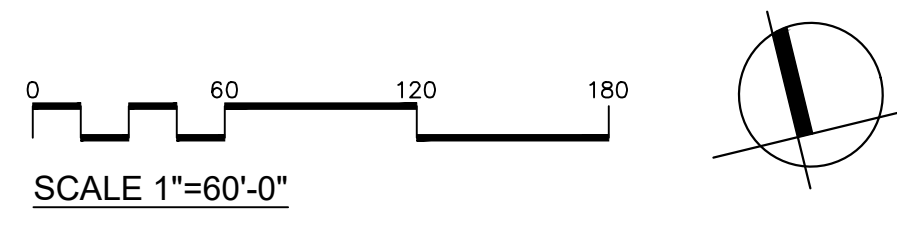

PEABODY RIVERWALK PARK RIVERWALK PARK SITE INDEX PLAN.dwg



**LEGEND**

	PROPERTY LINE		DECIDUOUS TREE		MONUMENT
	LIMIT OF WORK		CONIFEROUS TREE		IRON PIN / IRON ROD
	EASEMENTS		SHRUB/BUSH		HANDICAP SPACE
	100' WETLAND BUFFER		SIGN		SANITARY MANHOLE (SMH)
	200' RIVERFRONT PROTECTION AREA		UTILITY POLE		STORM MANHOLE (STMH)
	APPROXIMATE LIMIT OF EXISTING 100-YEAR FLOOD PLAIN		LIGHT POLE		CATCHBASIN (CB)
	MAJOR CONTOUR LINE		HYDRANT		METAL POST/BOLLARD (BOL)
	MINOR CONTOUR LINE		WATER SHUTOFF		ELECTRIC MANHOLE (MHE)
			GAS VALVE		UNKNOWN MANHOLE
			WATER VALVE		TELEPHONE MANHOLE (MHT)

**GENERAL NOTES**

- BEARINGS REFER TO THE MASSACHUSETTS NAD 83 STATE PLANE COORDINATE SYSTEM (MAINLAND ZONE).
- ELEVATIONS REFER TO THE NORTH AMERICAN VERTICAL DATUM OF 1988.
- REFERENCE IS MADE TO THE FOLLOWING MAPS:
  - "LAND OF ANNABLE BROS. PEABODY", BY GUY W. RICKER, SCALE 1"=20', DATED SEPT. 1902, RECORDED IN BOOK 1683, PLAN 438 OF THE ESSEX SOUTH REGISTRY OF DEEDS.
  - "LAND OF MORRILL LEATHER CO. PEABODY MASS.", BY GUY W. RICKER, SCALE 1"=20', DATED DEC. 1902, RECORDED AS MAP 1669 - 600.
  - "STATION MAP - LANDS BOSTON AND MAINE R.R. STATION 45+0 TO STATION 95+0", SCALE 1"=100', DATED JUNE 30, 1914, REVISED TO DEC. 1, 1975, RECORDED IN PLAN BOOK 141, PLAN 20 OF THE ESSEX SOUTH REGISTRY OF DEEDS.
  - "PLAN OF LAND IN PEABODY", BY THOMAS A. APPLETON, SCALE 1"=20', DATED OCT. 27, 1914, LAND COURT PLAN 5137A.
  - "PLAN OF LAND IN PEABODY", BY THOMAS A. APPLETON, SCALE 1"=20', DATED AUGUST 1916, RECORDED IN PLAN BOOK 30, PLAN 39 OF THE ESSEX SOUTH REGISTRY OF DEEDS.
  - PLAN OF LAND IN PEABODY", BY THOMAS A. APPLETON, SCALE 1"=20', DATED OCT. 1918, LAND COURT PLAN 6997A.
  - "PLAN OF LAND - PEABODY, MASS. BELONGING TO THE MORRILL LEATHER CO.", BY SHAY & SHAY, SCALE 1"=20', DATED FEB. 14, 1930, RECORDED AS PLAN 110 OF 1930 OF THE ESSEX SOUTH REGISTRY OF DEEDS.
  - "SUBDIVISION PLAN OF LAND IN PEABODY", BY OSBORN PALMER, SCALE 1"=40', DATED SEPTEMBER 1952, LAND COURT PLAN 6997C.
  - "PLAN OF LAND IN PEABODY PROPERTY OF HOWLEY REALTY TRUST OF PEABODY", BY OSBORN PALMER, INC., SCALE 1"=20', DATED FEB. 26, 1965, RECORDED IN PLAN BOOK 104, PLAN 12 OF THE ESSEX SOUTH REGISTRY OF DEEDS.
  - "SUBDIVISION PLAN OF LAND IN PEABODY", BY OSBORN PALMER INC, SCALE 1"=50', DATED MAY 26, 1966, LAND COURT PLAN 5137B.
  - "SUBDIVISION PLAN OF LAND IN PEABODY", BY OSBORN PALMER INC, SCALE 1"=50', DATED FEBRUARY 5, 1967, LAND COURT PLAN 5137C.

- "EASEMENT PLAN PEABODY-SALEM INTERCEPTING SEWER FROM SALEM-PEABODY LINE TO PEABODY SQUARE PEABODY, MASS." BY RAYMOND C. PRESSEY, INC. SCALE 1"=20', DATED APRIL 15, 1971, REVISED JUNE 15, 1971, RECORDED IN PLAN BOOK 121 PLAN 64 OF THE ESSEX SOUTH REGISTRY OF DEEDS.
- "PLAN OF LAND IN PEABODY PREPARED FOR E.H. PORTER CONSTRUCTION COMPANY", BY ESSEX SURVEY SERVICE, INC., SCALE 1"=20', DATED NOV. 28, 1975, RECORDED IN PLAN BOOK 136, PLAN 37 OF THE ESSEX SOUTH REGISTRY OF DEEDS.
- "PLAN OF LAND IN PEABODY PREPARED FOR BOB-KAT TANNING CO., INC.", BY ESSEX SURVEY SERVICE INC., SCALE 1"=20', DATED APRIL 27, 1976, RECORDED IN PLAN BOOK 144, PLAN 52 OF THE ESSEX SOUTH REGISTRY OF DEEDS.
- "COUNTY OF ESSEX, MASSACHUSETTS PLAN OF A PORTION OF WALLIS STREET FROM MAIN STREET TO WALNUT STREET IN THE CITY OF PEABODY AS RELOCATED", SCALE 1"=20', DATED MARCH 5, 1985, REVISED DEC. 4, 1990, COUNTY RECORD NUMBER 3204.
- "SUBDIVISION PLAN OF LAND LOCATED IN PEABODY, MASS.", BY EASTERN LAND SURVEY ASSOCIATES, INC., SCALE 1"=40', DATED JULY 14, 1986, REVISED NOVEMBER 7, 1989, RECORDED IN PLAN BOOK 260, PLAN 46 OF THE ESSEX SOUTH REGISTRY OF DEEDS.
- "SUBDIVISION PLAN OF LAND LOCATED IN PEABODY, MASS. PREPARED FOR EASTERN LAND SURVEY ASSOCIATES, INC., SCALE 1"=40', DATED APRIL 2, 2001, RECORDED IN PLAN BOOK 350, PLAN 53 OF THE ESSEX SOUTH REGISTRY OF DEEDS.
- "EASEMENT PLAN OF LAND LOCATED IN PEABODY, MASS." BY EASTERN LAND SURVEY ASSOCIATES, INC., SCALE 1"=20', DATED OCTOBER 18, 2004, RECORDED IN PLAN BOOK 386, PLAN 11 OF THE ESSEX SOUTH REGISTRY OF DEEDS.
- "SUBDIVISION PLAN OF LAND LOCATED IN PEABODY, MASSACHUSETTS", BY EASTERN LAND SURVEY ASSOCIATES, INC., SCALE 1"=40', DATED AUGUST 22, 2008, RECORDED IN PLAN BOOK 416, PLAN 7 OF THE ESSEX SOUTH REGISTRY OF DEEDS.
- "PLAN OF LAND LOCATED IN PEABODY, MASS.", BY EASTERN LAND SURVEY ASSOCIATES, INC., SCALE 1"=40', DATED MAY 17, 2010, RECORDED IN PLAN BOOK 424, PLAN 17 OF THE ESSEX SOUTH REGISTRY OF DEEDS.
- "PLAN OF LAND LOCATED IN PEABODY, MASSACHUSETTS (ESSEX COUNTY) PREPARED FOR MASSACHUSETTS BAY TRANSPORTATION AUTHORITY - CITY OF PEABODY", BY MERIDIAN ASSOCIATES, SCALE 1"=30', DATED MARCH 30, 2012, RECORDED IN PLAN BOOK 433, PLAN 91 OF THE ESSEX SOUTH REGISTRY OF DEEDS.

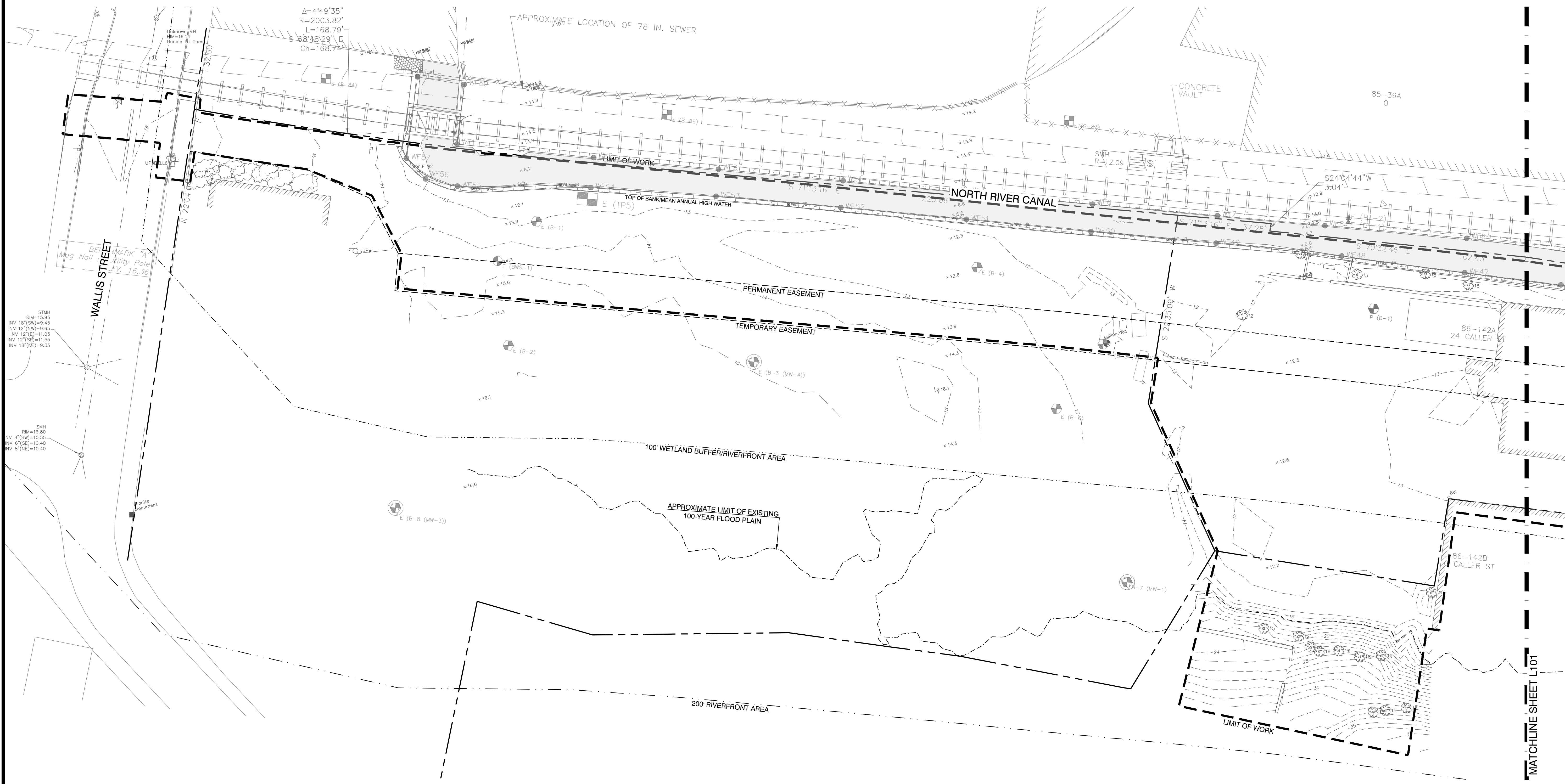

Project:  
**PEABODY RIVERWALK  
 RIVERWALK PARK**

WALLIS STREET -  
 CALLER STREET -  
 HOWLEY STREET  
 PEABODY, MA. 01960

**Weston & Sampson**  
 WESTON & SAMPSON ENGINEERS, INC.  
 85 DEVONSHIRE STREET, 3RD FLOOR  
 BOSTON, MA 02109  
 617-412-4480  
 www.westonandsampson.com

Consultants:

No.	Date	Description

Revisions:

No.	Date	Description

Seal:

Key Plan:

Issued For:  
**75% CONSTRUCTION DOCUMENTS  
 - NOT FOR CONSTRUCTION -**

Scale: 1" = 20'  
 Date: APRIL 2021  
 Drawn By: FD, TY, SG  
 Reviewed By: CC  
 Approved By: CFR

W&S Project No.: ENG20-0145  
 W&S File No.:

Drawing Title:  
**EXISTING  
 CONDITIONS PLAN**

Sheet Number:  
**L100**



**LEGEND**

	PROPERTY LINE		DECIDUOUS TREE		MONUMENT
	LIMIT OF WORK		CONIFEROUS TREE		IRON PIN / IRON ROD
	EASEMENTS		SHRUB/BUSH		HANDICAP SPACE
	100' WETLAND BUFFER		SIGN		SANITARY MANHOLE (SMH)
	200' RIVERFRONT PROTECTION AREA		UTILITY POLE		STORM MANHOLE (STMH)
	APPROXIMATE LIMIT OF EXISTING 100-YEAR FLOOD PLAIN		LIGHT POLE		CATCHBASIN (CB)
	MAJOR CONTOUR LINE		HYDRANT		METAL POST/BOLLARD (BOL)
	MINOR CONTOUR LINE		WATER SHUTOFF		ELECTRIC MANHOLE (MHE)
			GAS VALVE		UNKNOWN MANHOLE
			WATER VALVE		TELEPHONE MANHOLE (MHT)

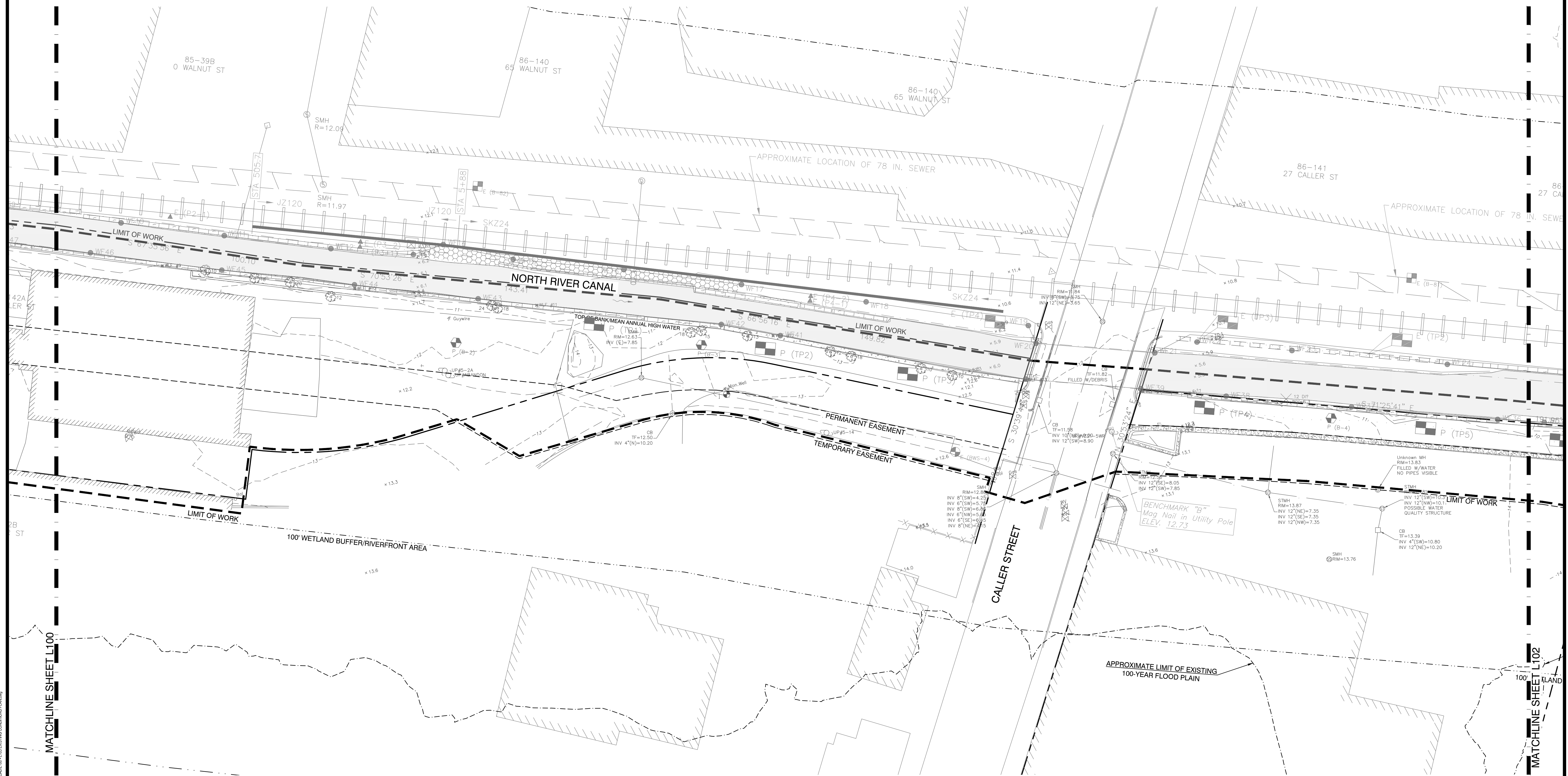

Project:  
**PEABODY RIVERWALK**  
 RIVERWALK PARK

WALLIS STREET -  
 CALLER STREET -  
 HOWLEY STREET  
 PEABODY, MA. 01960

**Weston & Sampson**  
 WESTON & SAMPSON ENGINEERS, INC.  
 85 DEVONSHIRE STREET, 3RD FLOOR  
 BOSTON, MA 02109  
 617-412-4480  
 www.westonandsampson.com

Consultants:

--

Revisions:

No.	Date	Description

Seal:

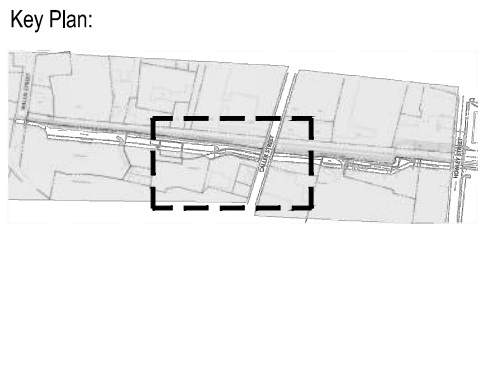

Issued For:  
**75% CONSTRUCTION DOCUMENTS**  
**- NOT FOR CONSTRUCTION -**

Scale: 1" = 20'

Date: APRIL 2021

Drawn By: FD, TY, SG

Reviewed By: CC

Approved By: CFR

W&S Project No.: ENG20-0145

W&S File No.:

Drawing Title:  
**EXISTING CONDITIONS PLAN**

Sheet Number:  
**L101**

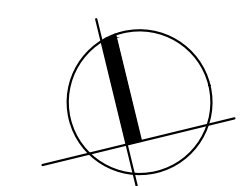
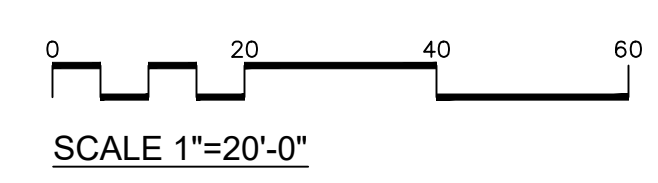

PEABODY RIVERWALK PARK CONSTRUCTION PLAN



**LEGEND**

	PROPERTY LINE		DECIDUOUS TREE		MONUMENT
	LIMIT OF WORK		CONIFEROUS TREE		IRON PIN / IRON ROD
	EASEMENTS		SHRUB/BUSH		HANDICAP SPACE
	100' WETLAND BUFFER		SIGN		SANITARY MANHOLE (SMH)
	200' RIVERFRONT PROTECTION AREA		UTILITY POLE		STORM MANHOLE (STMH)
	APPROXIMATE LIMIT OF EXISTING 100-YEAR FLOOD PLAIN		LIGHT POLE		CATCHBASIN (CB)
	MAJOR CONTOUR LINE		HYDRANT		METAL POST/BOLLARD (BOL)
	MINOR CONTOUR LINE		WATER SHUTOFF		ELECTRIC MANHOLE (MHE)
			GAS VALVE		UNKNOWN MANHOLE
			WATER VALVE		TELEPHONE MANHOLE (MHT)

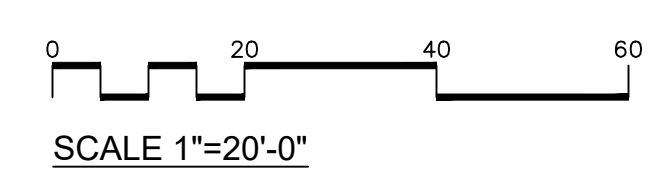
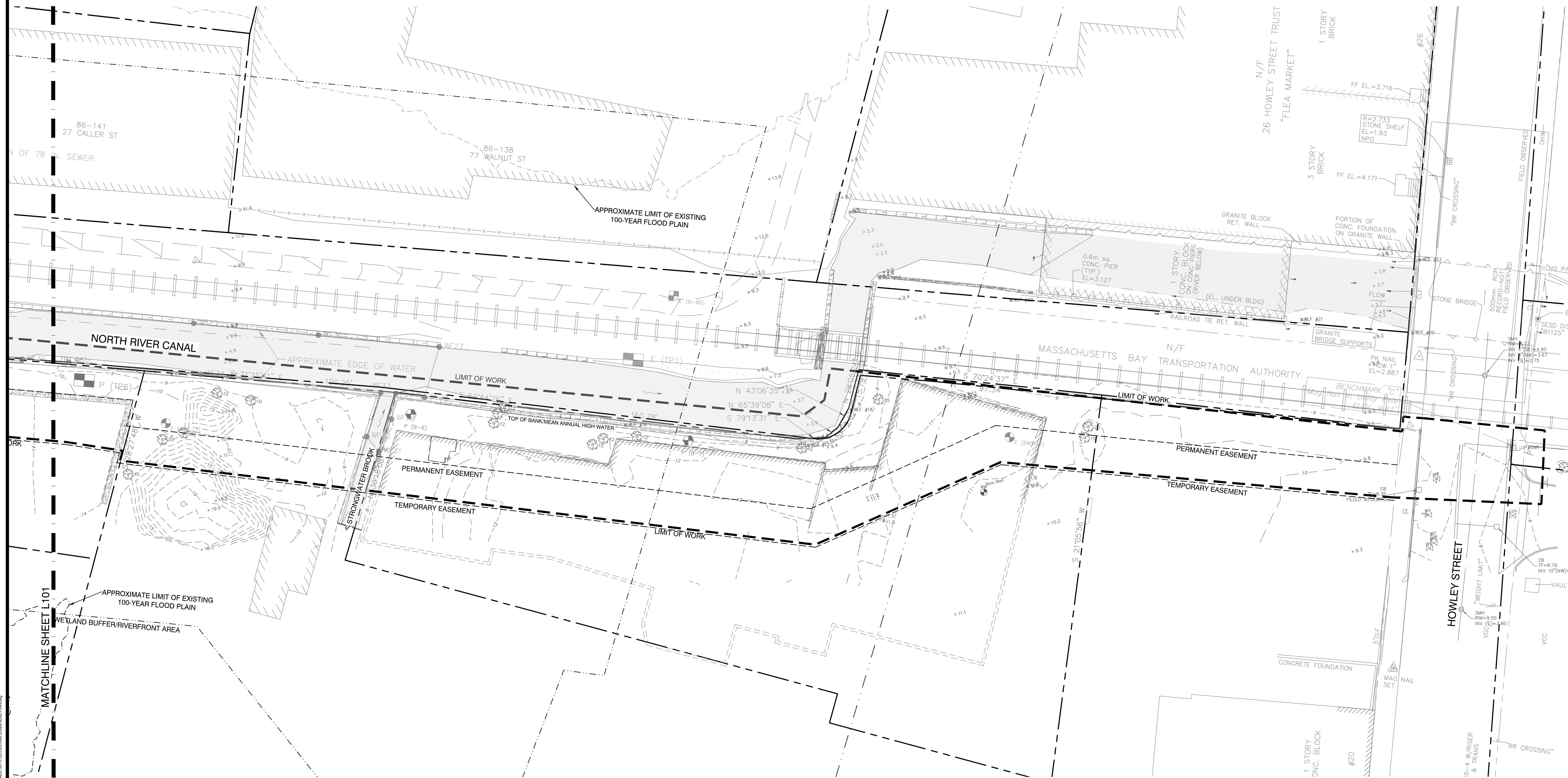

Project:  
**PEABODY RIVERWALK RIVERWALK PARK**  
  
 WALLIS STREET - CALLER STREET - HOWLEY STREET  
 PEABODY, MA. 01960

**Weston & Sampson**  
 WESTON & SAMPSON ENGINEERS, INC.  
 85 DEVONSHIRE STREET, 3RD FLOOR  
 BOSTON, MA 02109  
 617-412-4480  
 www.westonandsampson.com

Consultants:

--

Revisions:

No.	Date	Description

Seal:

Key Plan:

Issued For:

**75% CONSTRUCTION DOCUMENTS**  
**- NOT FOR CONSTRUCTION -**

Scale: 1" = 20'

Date: APRIL 2021

Drawn By: FD, TY, SG

Reviewed By: CC

Approved By: CFR

W&S Project No.: ENG20-0145  
 W&S File No.:

Drawing Title:

**EXISTING CONDITIONS PLAN**

Sheet Number:

**L102**



**LEGEND**

	PROPERTY LINE	TYP.	TYPICAL
	LIMIT OF WORK	EX.	EXISTING
	EASEMENTS	R&D	REMOVE AND DISPOSE
	100' WETLAND BUFFER	R&R	REMOVE AND RESET
	100' RIVERFRONT PROTECTION AREA	R&S	REMOVE AND STORE
	APPROXIMATE LIMIT OF EXISTING 100-YEAR FLOOD PLAIN		
	COMPOST SOCKS		

**DEMOLITION & SITE PREPARATION NOTES**

1. THE CONTRACTOR SHALL INCLUDE IN THE BID THE COST OF REMOVING ANY EXISTING SITE FEATURES NECESSARY TO ACCOMPLISH THE CONSTRUCTION OF THE PROPOSED SITE IMPROVEMENTS. THE CONTRACTOR SHALL ALSO INCLUDE IN THE BID THE COST NECESSARY TO RESTORE SUCH ITEMS IF THEY ARE DISTURBED YET SCHEDULED TO REMAIN AS PART OF THE FINAL SITE IMPROVEMENTS. REFER TO PLANS TO DETERMINE EXCAVATION AND DEMOLITION REQUIRED TO RECEIVE PROPOSED SITE IMPROVEMENTS AND TO DETERMINE THE LOCATION OF PROPOSED SITE IMPROVEMENTS.
2. THE OWNER RESERVES THE RIGHT TO REVIEW ALL MATERIALS DESIGNATED FOR REMOVAL AND TO RETAIN OWNERSHIP OF SUCH MATERIALS. IF THE OWNER RETAINS ANY MATERIAL THE CONTRACTOR SHALL MAKE ARRANGEMENTS WITH THE OWNER TO HAVE THOSE MATERIALS DELIVERED TO FRANKLIN PARK YARD AT NO ADDITIONAL EXPENSE TO THE OWNER.
3. UNLESS SPECIFICALLY NOTED TO BE SAVED OR REUSED, ALL SITE FEATURES CALLED FOR REMOVAL SHALL BE TRANSPORTED FROM THE SITE AND DISPOSED OF IN A LAWFUL MANNER AT AN ACCEPTABLE DISPOSAL SITE AT NO COST TO THE OWNER.
4. ALL EXISTING SITE FEATURES TO REMAIN SHALL BE PROTECTED THROUGHOUT THE CONSTRUCTION PERIOD. ANY FEATURES DAMAGED DURING CONSTRUCTION OPERATIONS SHALL BE REPAIRED OR REPLACED TO THE SATISFACTION OF THE OWNER AND OWNER'S REPRESENTATIVE AT NO ADDITIONAL COST TO THE OWNER.
5. DURING EARTHWORK OPERATIONS, CONTRACTOR SHALL TAKE CARE TO NOT DISTURB EXISTING MATERIALS TO REMAIN, OUTSIDE THE LIMITS OF EXCAVATION AND BACKFILL AND SHALL TAKE WHATEVER MEASURES NECESSARY, AT THE CONTRACTOR'S EXPENSE, TO PREVENT ANY EXCAVATED MATERIAL FROM COLLAPSING. ALL BACKFILL MATERIALS SHALL BE PLACED AND COMPACTED AS SPECIFIED TO THE SUBGRADE REQUIRED FOR THE INSTALLATION OF THE REMAINDER OF THE CONTRACT WORK.
6. ALL ITEMS CALLED FOR REMOVAL (COMPLETE) SHALL BE REMOVED TO FULL DEPTH INCLUDING ALL FOOTINGS, FOUNDATIONS, AND OTHER APPURTENANCES, EXCEPT AS SPECIFICALLY NOTED OTHERWISE.
7. CONTRACTOR SHALL INSTALL TREE PROTECTION BARRIER AT DRIPLINE AFTER CLEARING UNDERBRUSH AND TAKE DUE CARE TO PREVENT INJURY TO TREES DURING CLEARING OPERATIONS. TREES TO REMAIN SHALL BE PRUNED.
8. THE STORAGE OF MATERIALS AND EQUIPMENT WILL BE PERMITTED AT LOCATIONS DESIGNATED BY OWNER OR OWNER'S REPRESENTATIVE. PROTECTION OF STORED MATERIALS AND EQUIPMENT SHALL BE THE SOLE RESPONSIBILITY OF THE CONTRACTOR. THERE SHALL BE NO STORAGE OF MATERIALS OR PARKING OF CONSTRUCTION VEHICLES WITHIN DRIPLINE OF TREES.
9. **DEMOLITION AND SITE REMEDIATION OF 24 CALLER STREET SHALL BE COMPLETED BY OTHERS PRIOR TO THE COMMENCEMENT OF CONSTRUCTION**

10. ALL SEDIMENT AND EROSION CONTROL DEVICES SHALL BE PUT INTO PLACE PRIOR TO BEGINNING ANY CONSTRUCTION OR DEMOLITION.
11. THE CONTRACTOR SHALL BE RESPONSIBLE FOR THE CONTINUAL MAINTENANCE OF ALL EROSION CONTROL DEVICES THROUGHOUT THE DURATION OF THE PROJECT.
12. CONTRACTOR SHALL MEET ALL THE COMMONWEALTH OF MASSACHUSETTS D.E.P. AND THE CITY OF PEABODY'S WETLAND ORDINANCE REGULATIONS FOR SEDIMENT AND EROSION CONTROL.
13. THE CONTRACTOR SHALL PROVIDE DUST CONTROL FOR CONSTRUCTION OPERATIONS AS APPROVED BY OWNER.
14. ALL POINTS OF CONSTRUCTION EGRESS OR INGRESS SHALL BE MAINTAINED TO PREVENT TRACKING OR FLOWING OF SEDIMENT ONTO PUBLIC / PRIVATE ROADS.

**NOTES:**

1. CONTRACTOR SHALL PROVIDE 6'-HT CONSTRUCTION FENCE PLACED AT LIMIT OF WORK OR USE EXISTING FENCE IN PLACE. CONTRACTOR IS RESPONSIBLE FOR SECURING THE SITE AT ALL TIMES FOR THE DURATION OF THE CONSTRUCTION PERIOD.
2. CONTRACTOR MUST NOTIFY OWNER AND CITY OF PEABODY DEPARTMENT OF PUBLIC WORKS OF ANY WORK TO BE COMPLETED WITHIN THE RIGHT OF WAY FORTY-EIGHT (48) PRIOR TO COMMENCING WORK.
3. CONTRACTOR SHALL PROTECT ALL UTILITY POLES THAT FALL WITHIN THE LIMIT OF WORK.
4. CONTRACTOR SHALL CLEAR AND WATER JET ALL DRAINAGE STRUCTURES AND LINES WITHIN THE LIMIT OF WORK AND VERIFY WORKING CONDITION.

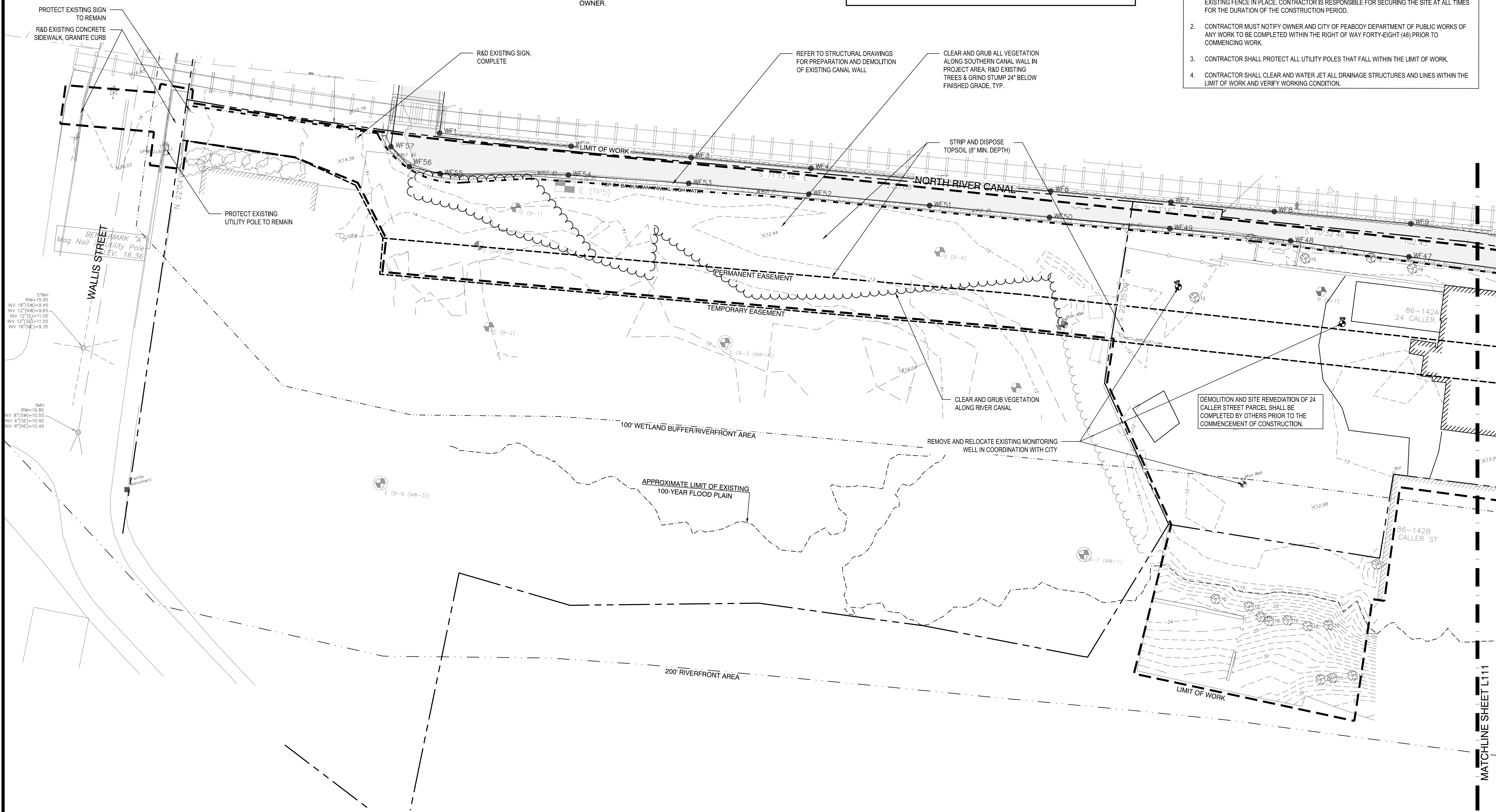

Project:  
**PEABODY RIVERWALK**  
 RIVERWALK PARK  
  
 WALLIS STREET -  
 CALLER STREET -  
 HOWLEY STREET  
 PEABODY, MA. 01960

**Weston & Sampson**  
 WESTON & SAMPSON ENGINEERS, INC.  
 85 DEVONSHIRE STREET, 3RD FLOOR  
 BOSTON, MA 02109  
 617-412-4480  
 www.westonandsampson.com

Consultants:

--	--	--

Revisions:

No.	Date	Description

Seal:

Key Plan:

Issued For:  
**75% CONSTRUCTION DOCUMENTS**  
 - NOT FOR CONSTRUCTION -

Scale: 1" = 20'  
 Date: APRIL 2021  
 Drawn By: FD, TY, SG  
 Reviewed By: CC  
 Approved By: CFR

W&S Project No.: ENG20-0145  
 W&S File No.:

Drawing Title:  
**SITE DEMOLITION AND PREPARATION PLAN**

Sheet Number:  
**L110**

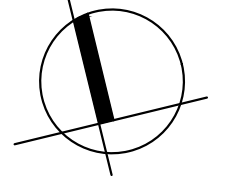
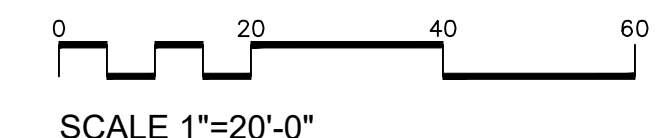

PEABODY RIVERWALK PARK CONSTRUCTION DOCUMENTS, TITLE: SITE DEMOLITION AND PREPARATION PLAN



**LEGEND**

	PROPERTY LINE	TYP.	TYPICAL
	LIMIT OF WORK	EX.	EXISTING
	EASEMENTS	R&D	REMOVE AND DISPOSE
	100' WETLAND BUFFER	R&R	REMOVE AND RESET
	100' RIVERFRONT PROTECTION AREA	R&S	REMOVE AND STORE
	APPROXIMATE LIMIT OF EXISTING 100-YEAR FLOOD PLAIN		
	COMPOST SOCKS		

Project:  
**PEABODY RIVERWALK RIVERWALK PARK**  
  
 WALLIS STREET - CALLER STREET - HOWLEY STREET  
 PEABODY, MA. 01960

**Weston & Sampson**  
 WESTON & SAMPSON ENGINEERS, INC.  
 85 DEVONSHIRE STREET, 3RD FLOOR  
 BOSTON, MA 02109  
 617-412-4480  
 www.westonandsampson.com

Consultants:

Revisions:

No.	Date	Description

Seal:

Key Plan:

Issued For:  
**75% CONSTRUCTION DOCUMENTS**  
**- NOT FOR CONSTRUCTION -**

Scale: 1" = 20'

Date: APRIL 2021  
 Drawn By: FD, TY, SG  
 Reviewed By: CC  
 Approved By: CFR

W&S Project No.: ENG20-0145  
 W&S File No.:

Drawing Title:  
**SITE DEMOLITION AND PREPARATION PLAN**

Sheet Number:  
**L111**

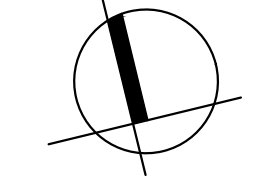
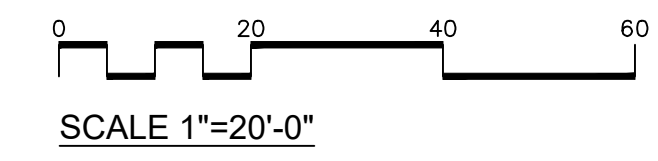
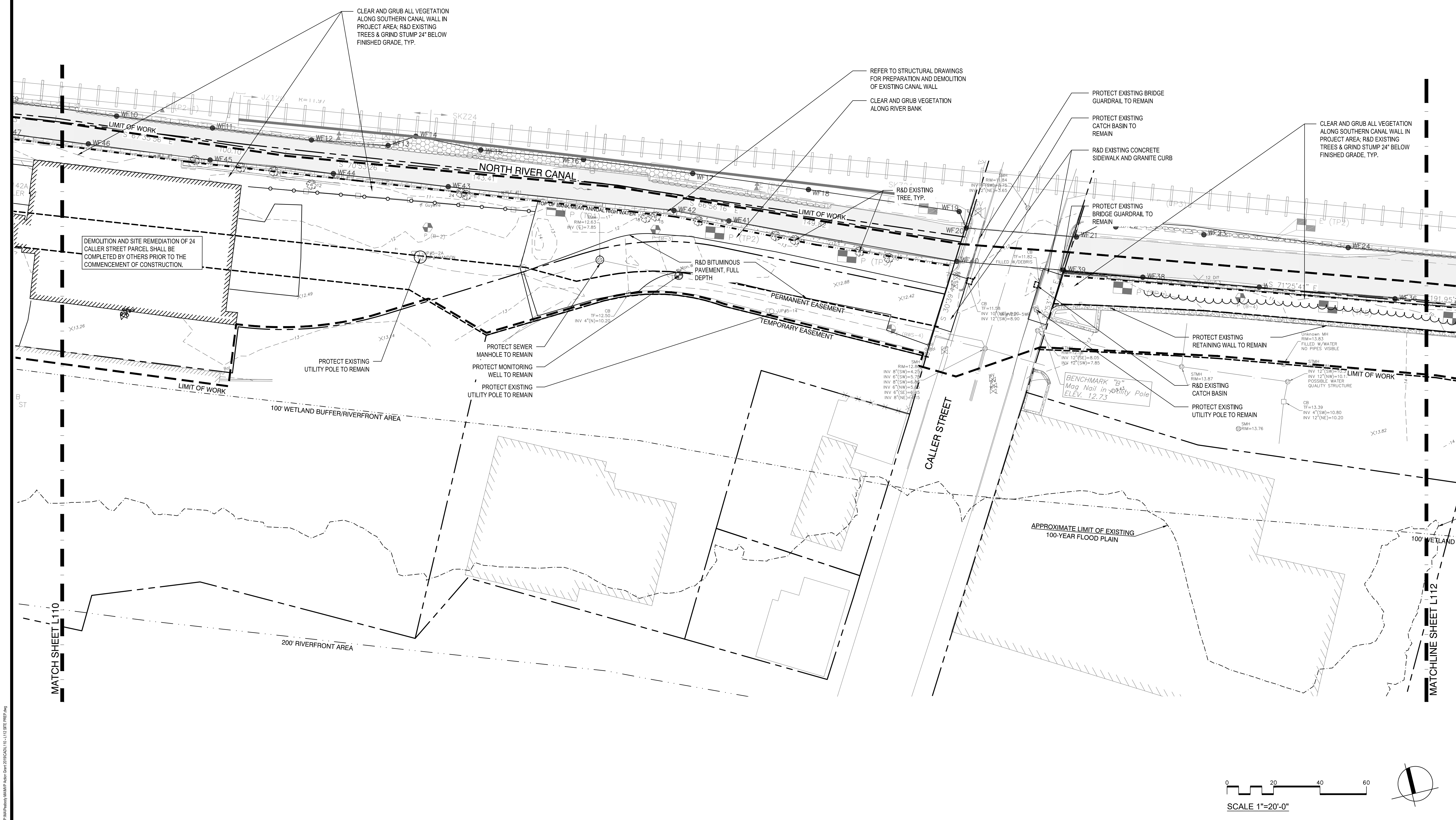

PEABODY RIVERWALK PARK - WESTON & SAMPSON ENGINEERS, INC. - 11/20/2021 10:58 AM



**LEGEND**

	PROPERTY LINE	TYP.	TYPICAL
	LIMIT OF WORK	EX.	EXISTING
	EASEMENTS	R&D	REMOVE AND DISPOSE
	100' WETLAND BUFFER	R&R	REMOVE AND RESET
	100' RIVERFRONT PROTECTION AREA	R&S	REMOVE AND STORE
	APPROXIMATE LIMIT OF EXISTING 100-YEAR FLOOD PLAIN		
	COMPOST SOCKS		
	INLET SEDIMENT CONTROL		
	CLEAR AND GRUB VEGETATION		

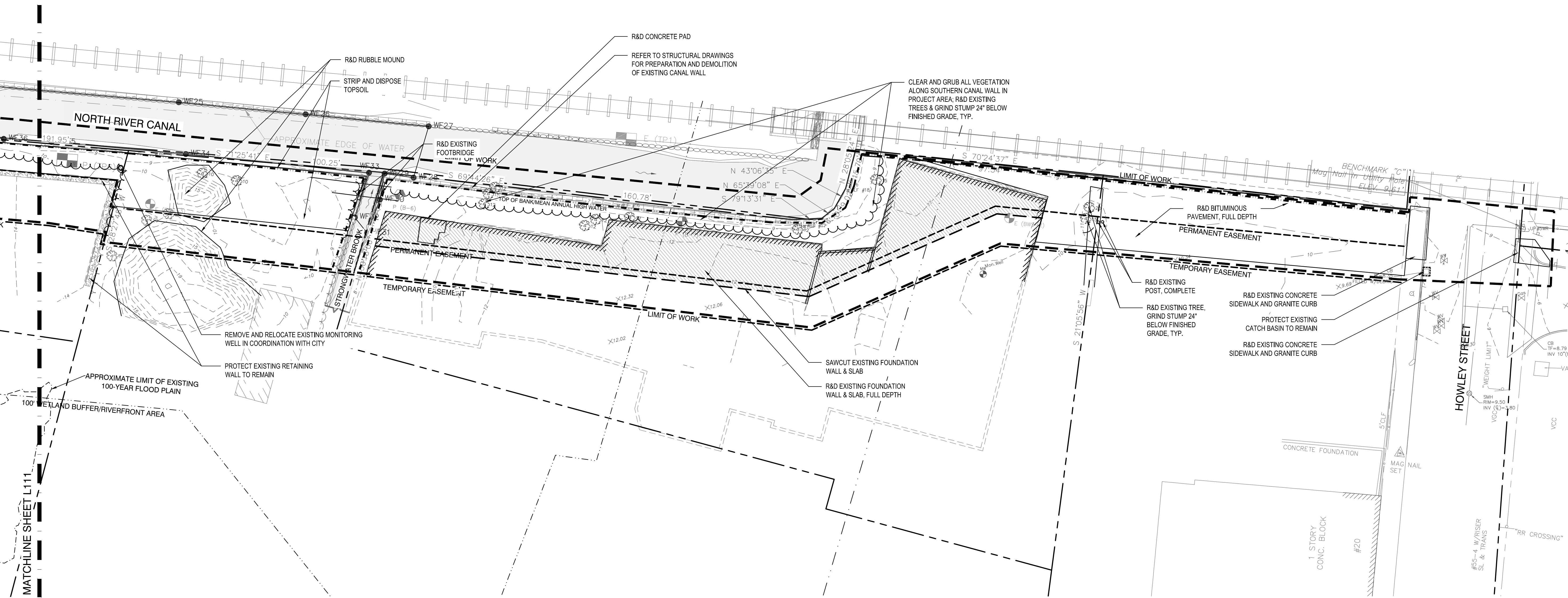

Project:  
**PEABODY RIVERWALK RIVERWALK PARK**  
  
 WALLIS STREET -  
 CALLER STREET -  
 HOWLEY STREET  
 PEABODY, MA. 01960

**Weston & Sampson**  
 WESTON & SAMPSON ENGINEERS, INC.  
 85 DEVONSHIRE STREET, 3RD FLOOR  
 BOSTON, MA 02109  
 617-412-4480  
 www.westonandsampson.com

Consultants:

Revisions:

No.	Date	Description

Seal:

Key Plan:

Issued For:  
**75% CONSTRUCTION DOCUMENTS**  
**- NOT FOR CONSTRUCTION -**

Scale: 1" = 20'

Date: APRIL 2021

Drawn By: FD, TY, SG

Reviewed By: CC

Approved By: CFR

W&S Project No.: ENG20-0145

W&S File No.:

Drawing Title:  
**SITE DEMOLITION AND PREPARATION PLAN**

Sheet Number:  
**L112**

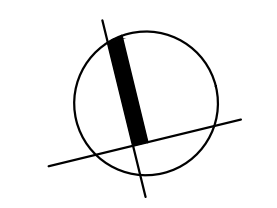
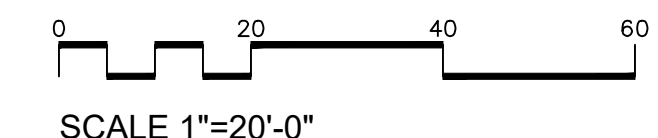

PEABODY RIVERWALK PARK CONSTRUCTION DOCUMENTS, TITLE SHEET PREPARING



**LEGEND**

	PROPERTY LINE		VEHICULAR BITUMINOUS CONCRETE PAVEMENT		STREET LIGHT
	LIMIT OF WORK		BOARDWALK		PEDESTRIAN LIGHT
	EASEMENTS		SLOPE WITH TURF REINFORCEMENT MAT, LOAM, AND NO MOW SEED MIX		RAPID FLASHING BEACON
	100' WETLAND BUFFER		VEGETATED BUFFER PLANTING		EMERGENCY CALL BOX
	200' RIVERFRONT PROTECTION AREA		CIP CONCRETE PAVEMENT		COLLAPSIBLE BOLLARD
	APPROXIMATE LIMIT OF EXISTING 100-YEAR FLOOD PLAIN		EXPANSION JOINT (EJ)		TRASH AND RECYCLE RECEPTACLES ON CONCRETE SLAB
	SHEET PILE WALL		SCORE JOINT (SJ)		DRAIN MANHOLE
	FENCE WITH CABLE RAILING ON BOARDWALK		BENCH WITH BACK		CATCH BASIN
	FENCE WITH CABLE RAILING ON MOW CURB				
	PEDESTRIAN BITUMINOUS CONCRETE PAVEMENT				

- MATERIALS NOTES**
- REFER TO EXISTING CONDITIONS PLAN FOR SURVEY INFORMATION.
  - REFER TO PLANTING PLAN FOR PLANT TYPES AND LOCATIONS.
  - ALL PROPOSED PAVEMENTS SHALL MEET THE LIEN AND GRADE OF EXISTING ADJACENT PAVEMENT SURFACES AND SHALL BE TREATED WITH RS-1 TACK COAT AND INFRARED LIGHT AT ALL POINTS OF CONNECTION AND ALL SAWCUT EDGES WHERE PROPOSED PAVEMENT MEETS EXISTING PAVEMENT.
  - THE DEPTH OF LOAM TOP SOIL FOR ALL RESTORED LAWN AREAS SHALL BE 6" MINIMUM. ALL DISTURBED AREAS SHALL BE RESTORED WITH LOAM AND SEED UNLESS OTHERWISE NOTED.
  - ALL LIGHTING CONTROLS TO BE COORDINATED WITH THE CITY OF PEABODY.

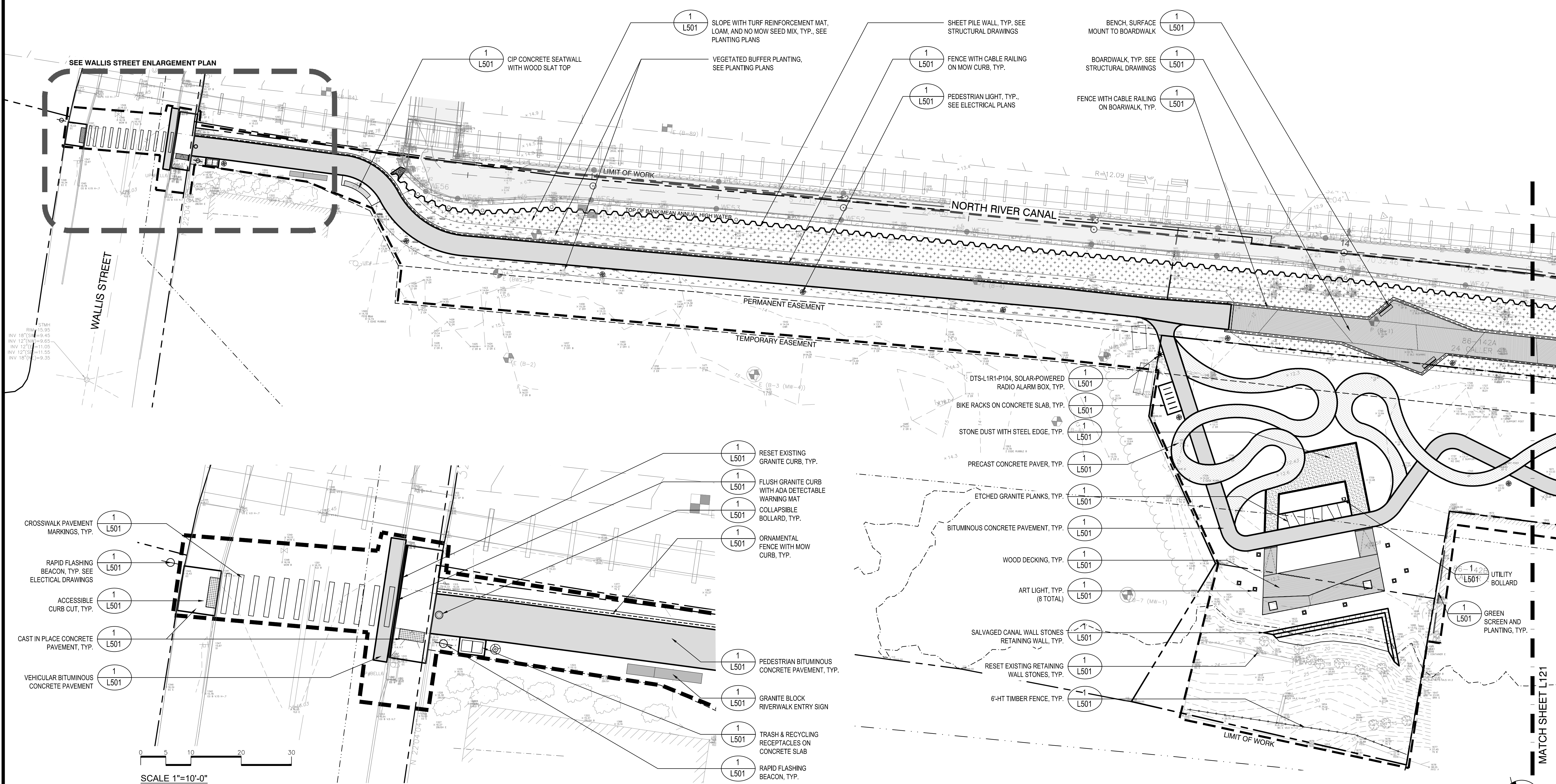

**1 WALLIS STREET ENLARGEMENT PLAN**  
SCALE: 1" = 10'-0"

SCALE 1" = 20'-0"

Project:  
**PEABODY RIVERWALK RIVERWALK PARK**  
  
 WALLIS STREET -  
 CALLER STREET -  
 HOWLEY STREET  
 PEABODY, MA 01960

**Weston & Sampson**  
 WESTON & SAMPSON ENGINEERS, INC.  
 85 DEVONSHIRE STREET, 3RD FLOOR  
 BOSTON, MA 02109  
 617-412-4480  
 www.westonandsampson.com

Consultants:

--	--	--

Revisions:

No.	Date	Description

Seal:

Key Plan:

Issued For:

**75% CONSTRUCTION DOCUMENTS**  
**- NOT FOR CONSTRUCTION -**

Scale: AS SHOWN

Date: APRIL 2021

Drawn By: FD, TY, SG

Reviewed By: CC

Approved By: CFR

W&S Project No.: ENG20-0145

W&S File No.:

Drawing Title:

**MATERIALS PLAN**

Sheet Number:

**L120**



**LEGEND**

- PROPERTY LINE
- LIMIT OF WORK
- EASEMENTS
- 100' WETLAND BUFFER
- 200' RIVERFRONT PROTECTION AREA
- APPROXIMATE LIMIT OF EXISTING 100-YEAR FLOOD PLAIN
- SHEET PILE WALL
- FENCE WITH CABLE RAILING ON BOARDWALK
- FENCE WITH CABLE RAILING ON MOW CURB
- PEDESTRIAN BITUMINOUS CONCRETE PAVEMENT
- VEHICULAR BITUMINOUS CONCRETE PAVEMENT
- BOARDWALK
- SLOPE WITH TURF REINFORCEMENT MAT, LOAM, AND NO MOW SEED MIX
- VEGETATED BUFFER PLANTING
- CIP CONCRETE PAVEMENT
- EXPANSION JOINT (EJ)
- SCORE JOINT (SJ)
- BENCH WITH BACK
- STREET LIGHT
- PEDESTRIAN LIGHT
- RAPID FLASHING BEACON
- EMERGENCY CALL BOX
- COLLAPSIBLE BOLLARD
- TRASH AND RECYCLE RECEPTACLES ON CONCRETE SLAB
- DRAIN MANHOLE
- CATCH BASIN

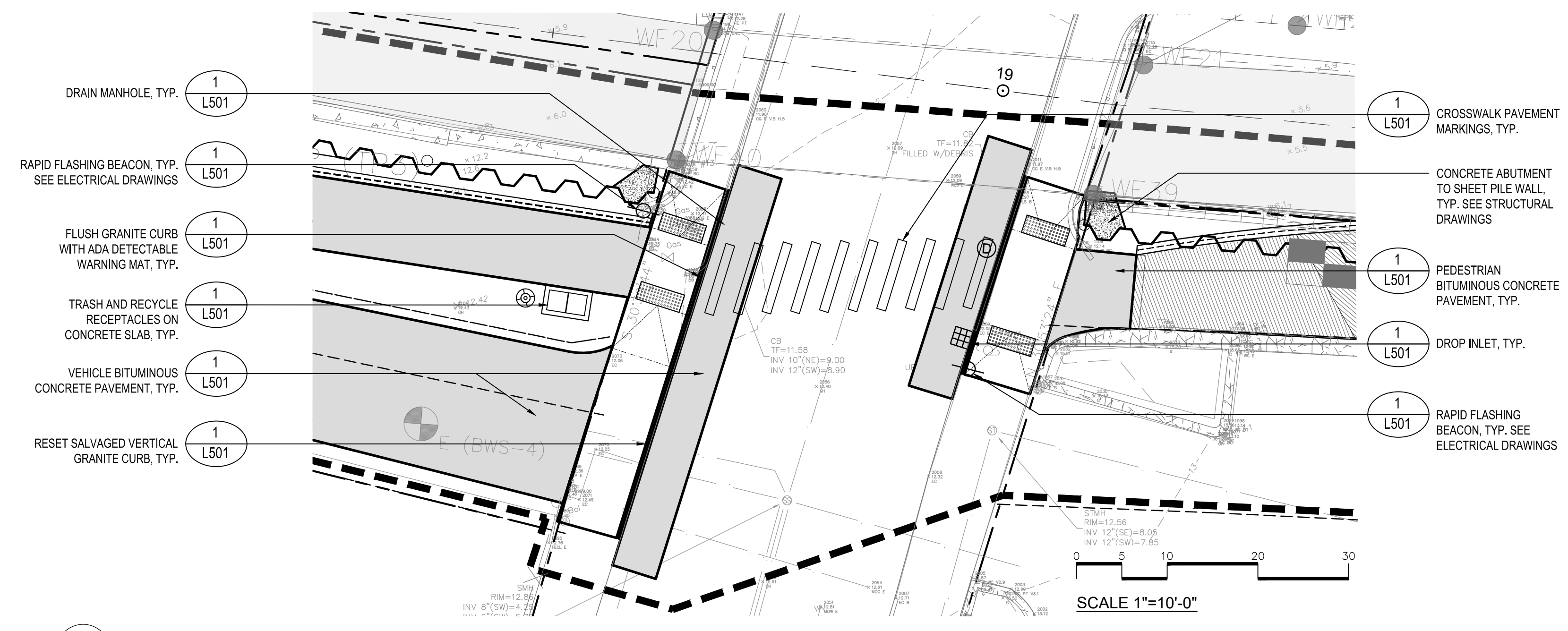

**1 CALLER STREET ENLARGEMENT PLAN**  
SCALE: 1" = 10'-0"

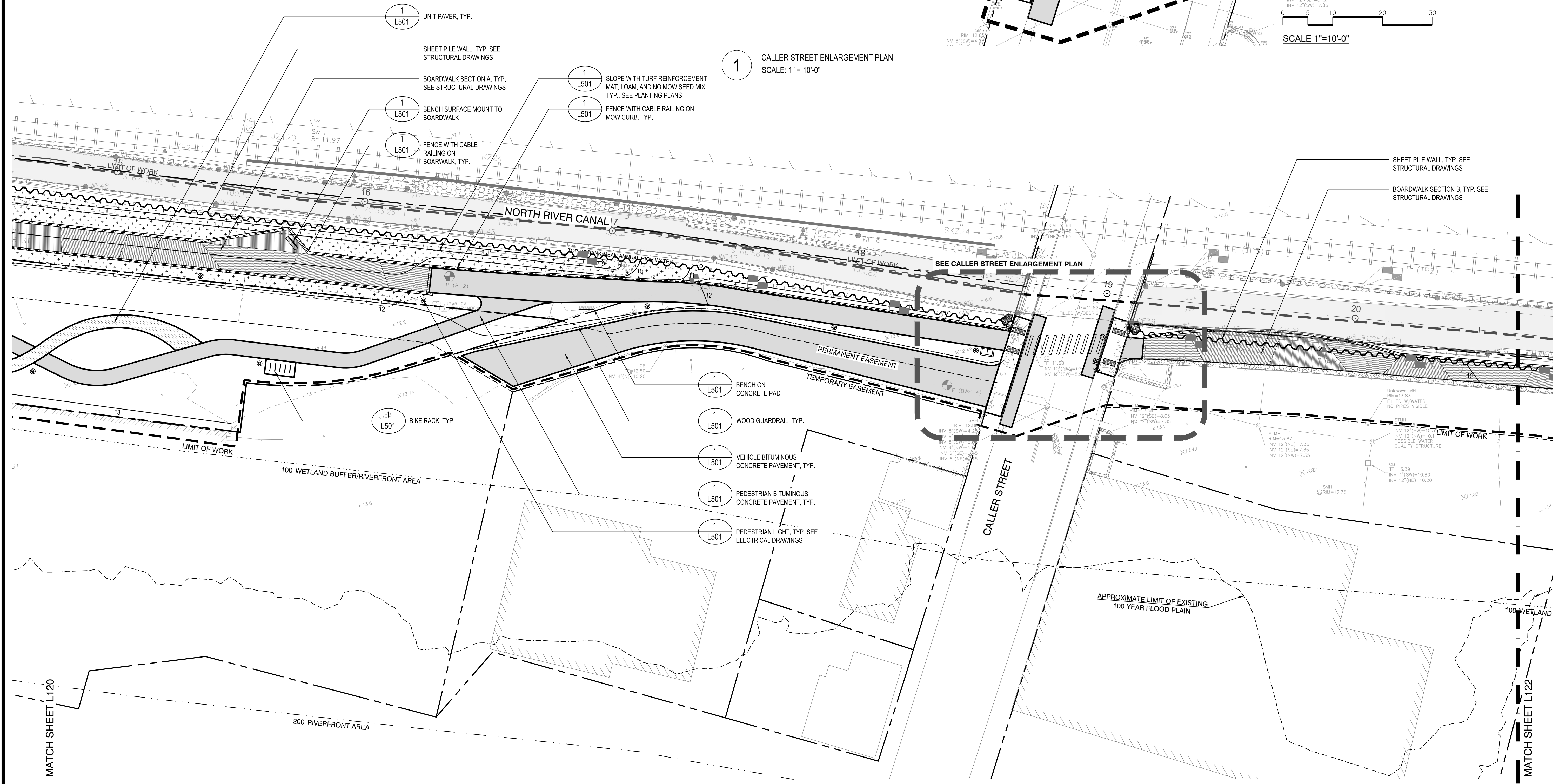

**SCALE 1"=20'-0"**

Project:  
**PEABODY RIVERWALK RIVERWALK PARK**  
  
 WALLIS STREET - CALLER STREET - HOWLEY STREET  
 PEABODY, MA. 01960

**Weston & Sampson**  
 WESTON & SAMPSON ENGINEERS, INC.  
 85 DEVONSHIRE STREET, 3RD FLOOR  
 BOSTON, MA 02109  
 617-412-4480  
 www.westonandsampson.com

Consultants:  
 \_\_\_\_\_  
 \_\_\_\_\_

Revisions:

No.	Date	Description

Seal:  
 \_\_\_\_\_

Key Plan:

Issued For:  
**75% CONSTRUCTION DOCUMENTS**  
**- NOT FOR CONSTRUCTION -**

Scale: AS SHOWN

Date: APRIL 2021

Drawn By: FD, TY, SG

Reviewed By: CC

Approved By: CFR

W&S Project No.: ENG20-0145  
 W&S File No.: \_\_\_\_\_

Drawing Title:  
**MATERIALS PLAN**

Sheet Number:  
**L121**



**LEGEND**

	PROPERTY LINE		VEHICULAR BITUMINOUS CONCRETE PAVEMENT		STREET LIGHT
	LIMIT OF WORK		BOARDWALK		PEDESTRIAN LIGHT
	EASEMENTS		SLOPE WITH TURF REINFORCEMENT MAT, LOAM, AND NO MOW SEED MIX		RAPID FLASHING BEACON
	100' WETLAND BUFFER		VEGETATED BUFFER PLANTING		EMERGENCY CALL BOX
	200' RIVERFRONT PROTECTION AREA		CIP CONCRETE PAVEMENT		COLLAPSIBLE BOLLARD
	APPROXIMATE LIMIT OF EXISTING 100-YEAR FLOOD PLAN		EXPANSION JOINT (EJ)		TRASH AND RECYCLE RECEPTACLES ON CONCRETE SLAB
	SHEET PILE WALL		SCORE JOINT (SJ)		DRAIN MANHOLE
	FENCE WITH CABLE RAILING ON BOARDWALK		BENCH WITH BACK		CATCH BASIN
	FENCE WITH CABLE RAILING ON MOW CURB				
	PEDESTRIAN BITUMINOUS CONCRETE PAVEMENT				

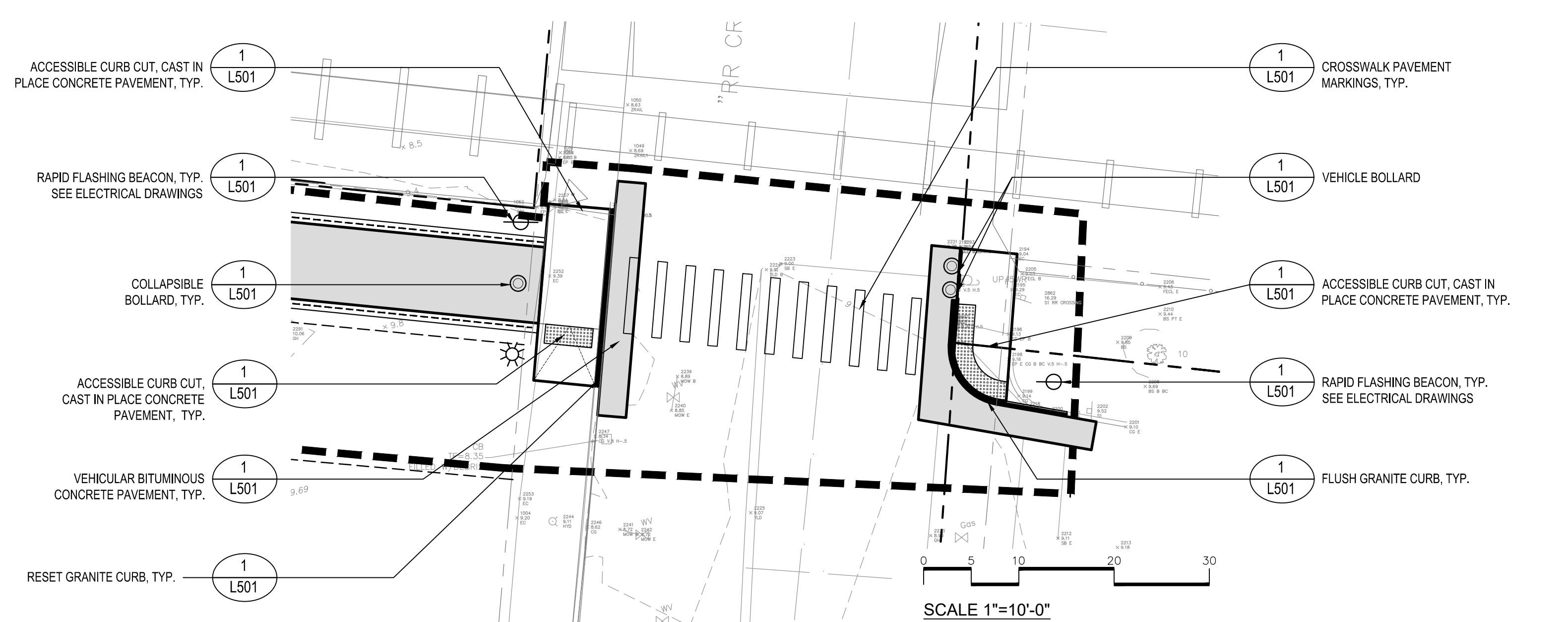

**1** HOWLEY STREET ENLARGEMENT PLAN  
SCALE: 1" = 10'-0"

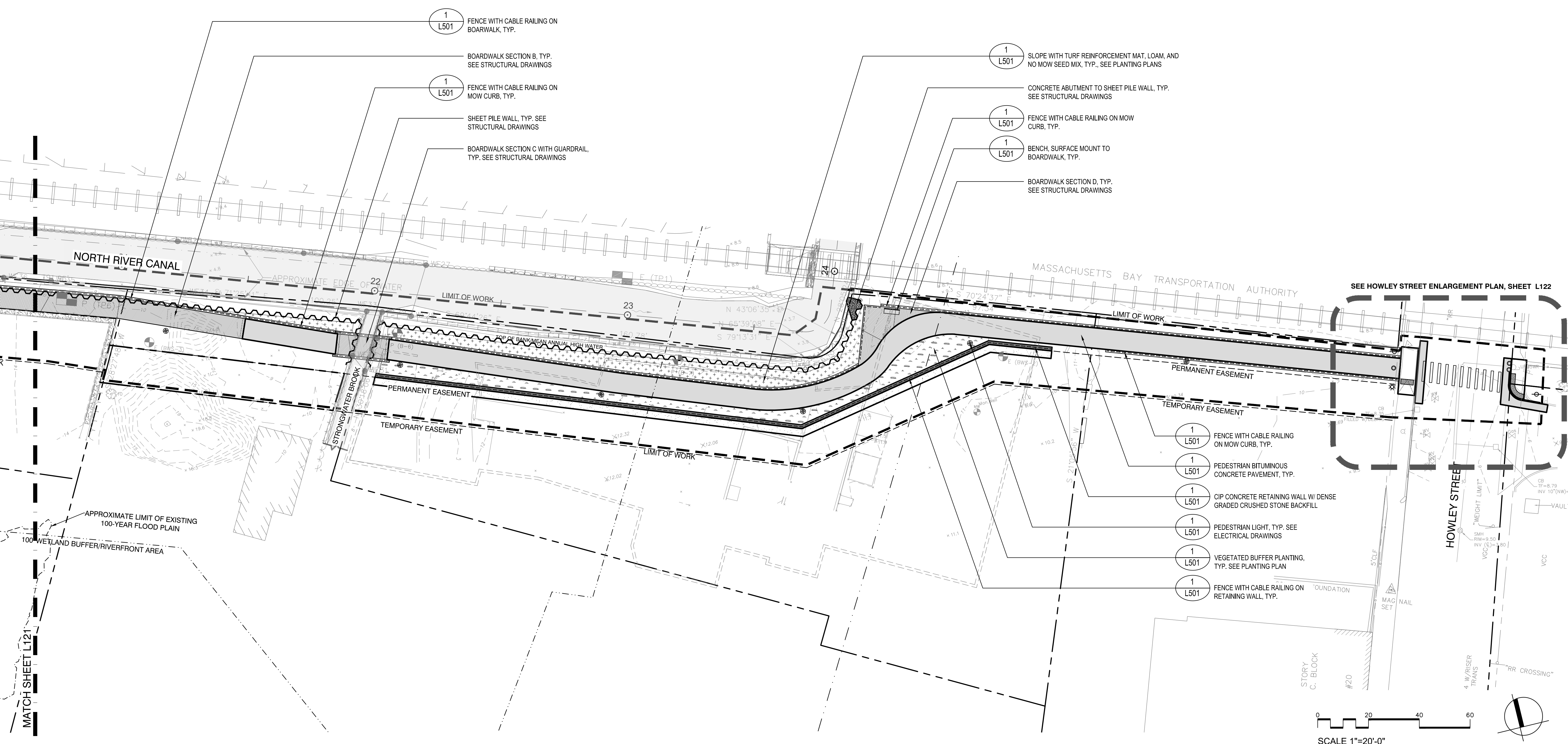

SCALE 1"=20'-0"

Project:  
PEABODY RIVERWALK  
RIVERWALK PARK

WALLIS STREET -  
CALLER STREET -  
HOWLEY STREET  
PEABODY, MA. 01960

**Weston & Sampson**  
WESTON & SAMPSON ENGINEERS, INC.  
85 DEVONSHIRE STREET, 3RD FLOOR  
BOSTON, MA 02109  
617-412-4480  
www.westonandsampson.com

Consultants:

--	--	--

Revisions:

No.	Date	Description

Seal:

Key Plan:

Issued For:  
**75% CONSTRUCTION DOCUMENTS**  
**- NOT FOR CONSTRUCTION -**

Scale: AS SHOWN  
Date: APRIL 2021  
Drawn By: FD, TY, SG  
Reviewed By: CC  
Approved By: CFR

W&S Project No.: ENG20-0145  
W&S File No.:

Drawing Title:  
**MATERIALS PLAN**

Sheet Number:  
**L122**



**LEGEND**

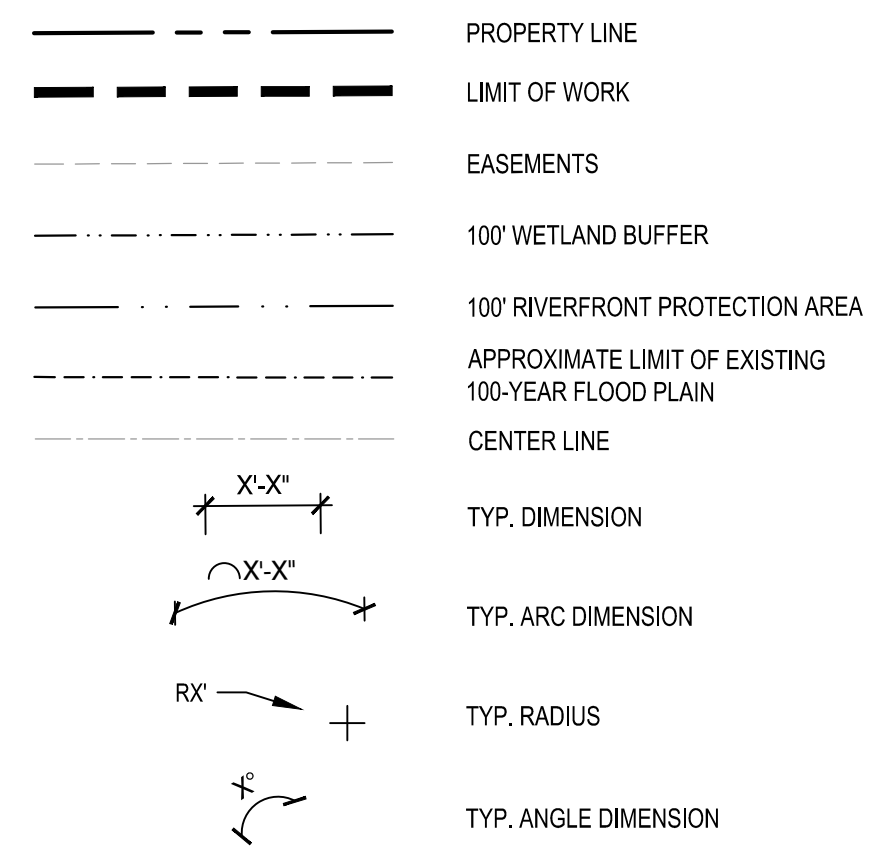

**LAYOUT NOTES**

1. COORDINATE ALL LAYOUT ACTIVITIES WITH THE SCOPE OF WORK CALLED FOR BY DEMOLITION, GRADING, AND UTILITIES OPERATIONS ENCOMPASSED BY THIS CONTRACT. SET, PROTECT, AND REPLACE REFERENCE STAKES AS NECESSARY OR AS DIRECTED BY THE OWNER'S REPRESENTATIVE.
2. ALL LINES AND GRADING WORK AS PER DRAWINGS AND SPECIFICATIONS SHALL BE LAID OUT BY A MASSACHUSETTS REGISTERED CIVIL ENGINEER OR LICENSED SURVEYOR ENGAGED BY THE GENERAL CONTRACTOR.
3. ALL LAYOUT LINES, OFFSETS, OR REFERENCES TO LOCATING OBJECTS ARE EITHER PARALLEL OR PERPENDICULAR UNLESS OTHERWISE DESIGNATED WITH ANGLE OFFSETS NOTED.
4. ALL PROPOSED SITE FEATURES SHALL BE LAID OUT AND STAKED FOR REVIEW AND APPROVAL BY THE OWNER'S REPRESENTATIVE PRIOR TO COMMENCEMENT OF INSTALLATION. ANY REQUIRED ADJUSTMENTS TO THE LAYOUT SHALL BE UNDERTAKEN AS DIRECTED AT NO ADDITIONAL COST TO THE OWNER.
5. THE CONTRACTOR SHALL VERIFY ALL DIMENSIONS AND GRADES ON THE GROUND AND REPORT ANY DISCREPANCIES IMMEDIATELY TO THE OWNER AND OWNER'S REPRESENTATIVE.
6. LAYOUT AND DIMENSIONS PROVIDED FOR BIDDING PURPOSES ONLY. CONTRACTOR SHALL COORDINATE WITH OWNER'S REPRESENTATIVE FOR FINAL LAYOUT AND DIMENSION PLAN.

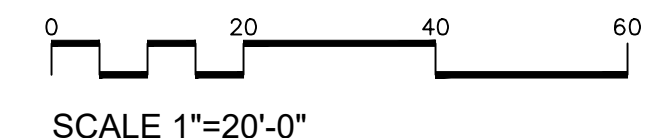
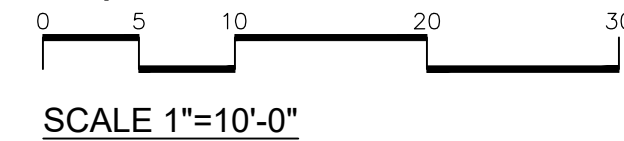
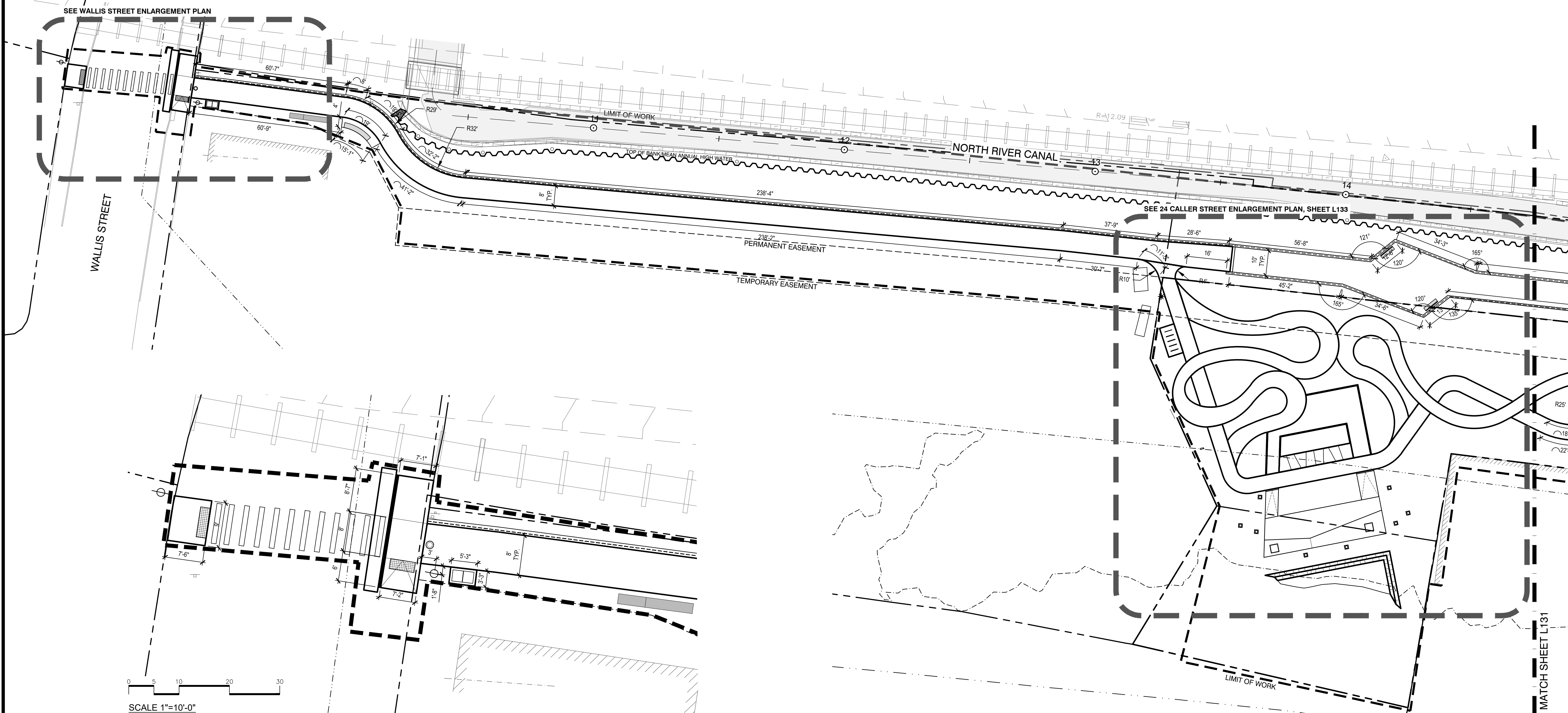

1 WALLIS ST ENLARGEMENT PLAN  
SCALE: 1" = 10'-0"

Project:  
**PEABODY RIVERWALK  
 RIVERWALK PARK**

WALLIS STREET -  
 CALLER STREET -  
 HOWLEY STREET  
 PEABODY, MA. 01960

**Weston & Sampson**  
 WESTON & SAMPSON ENGINEERS, INC.  
 85 DEVONSHIRE STREET, 3RD FLOOR  
 BOSTON, MA 02109  
 617-412-4480  
 www.westonandsampson.com

Consultants:

Revisions:

No.	Date	Description

Seal:

Key Plan:

Issued For:  
**75% CONSTRUCTION  
 DOCUMENTS  
 - NOT FOR CONSTRUCTION -**

Scale: AS SHOWN  
 Date: APRIL 2021  
 Drawn By: FD, TY, SG  
 Reviewed By: CC  
 Approved By: CFR

W&S Project No.: ENG20-0145  
 W&S File No.:

Drawing Title:  
**LAYOUT PLAN**

Sheet Number:  
**L130**



**LEGEND**

	PROPERTY LINE
	LIMIT OF WORK
	EASEMENTS
	100' WETLAND BUFFER
	100' RIVERFRONT PROTECTION AREA
	APPROXIMATE LIMIT OF EXISTING 100-YEAR FLOOD PLAIN
	CENTER LINE
	TYP. DIMENSION
	TYP. ARC DIMENSION
	TYP. RADIUS
	TYP. ANGLE DIMENSION

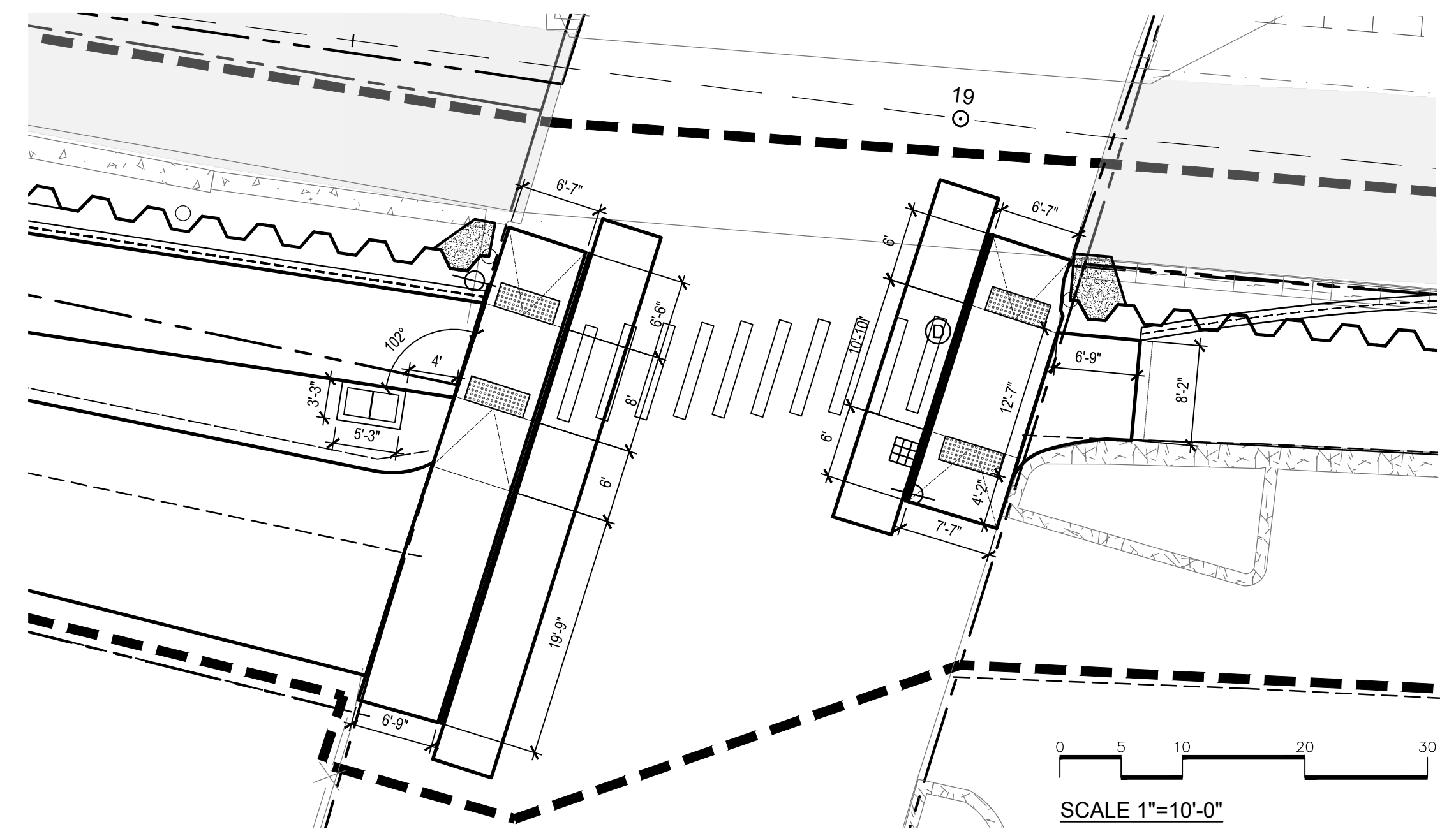

**1** CALLER STREET ENLARGEMENT PLAN  
SCALE: 1" = 10'-0"

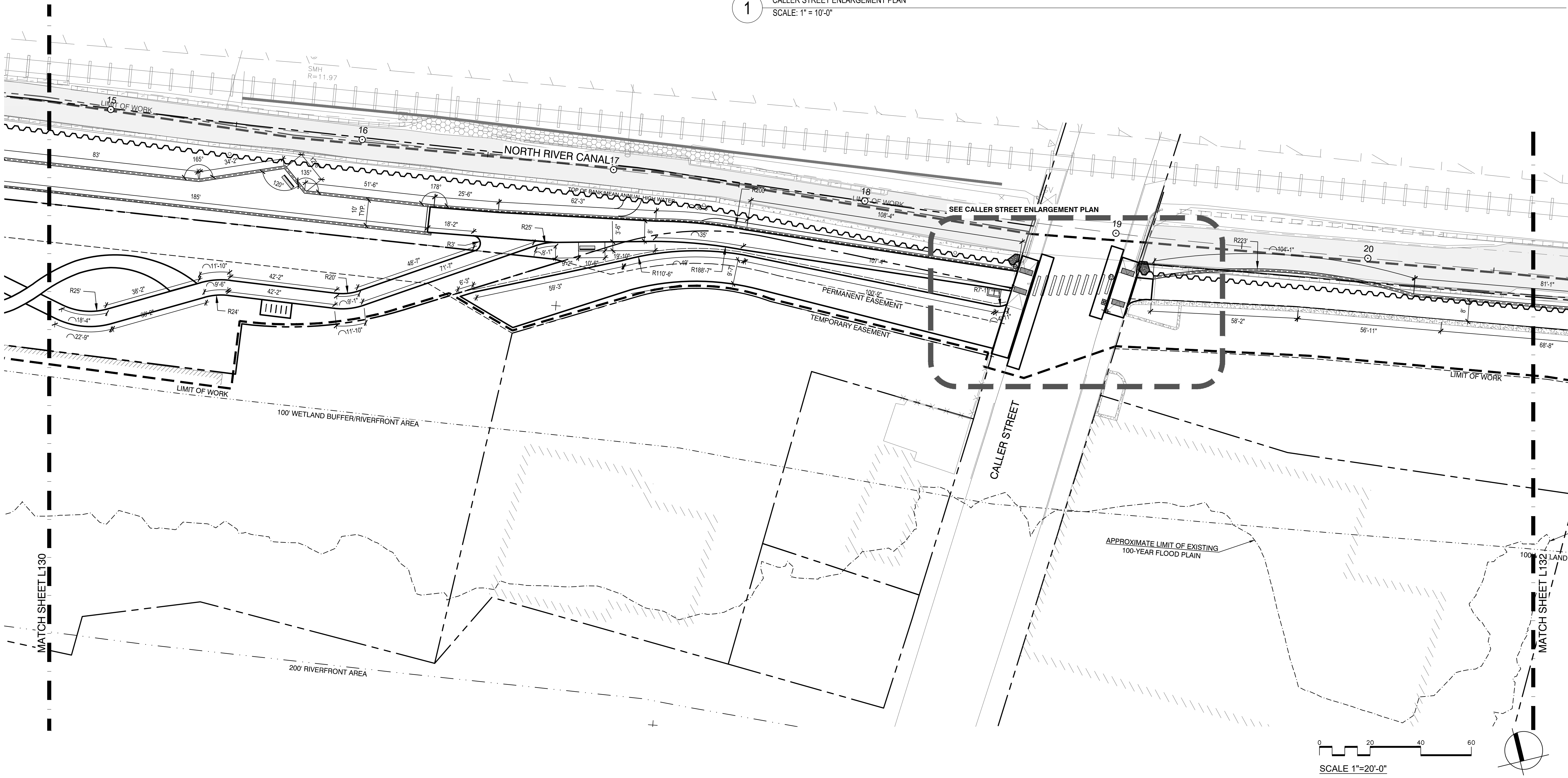

SCALE 1" = 20'-0"

Project:  
PEABODY RIVERWALK  
RIVERWALK PARK

WALLIS STREET -  
CALLER STREET -  
HOWLEY STREET  
PEABODY, MA. 01960

**Weston & Sampson**  
WESTON & SAMPSON ENGINEERS, INC.  
85 DEVONSHIRE STREET, 3RD FLOOR  
BOSTON, MA 02109  
617-412-4480  
www.westonandsampson.com

Consultants:

--

Revisions:

No.	Date	Description

Seal:

Key Plan:

Issued For:

**75% CONSTRUCTION DOCUMENTS  
- NOT FOR CONSTRUCTION -**

Scale: AS SHOWN

Date: APRIL 2021

Drawn By: FD, TY, SG

Reviewed By: CC

Approved By: CFR

W&S Project No.: ENG20-0145

W&S File No.:

Drawing Title:

**LAYOUT PLAN**

Sheet Number:

**L131**



**LEGEND**

	PROPERTY LINE
	LIMIT OF WORK
	EASEMENTS
	100' WETLAND BUFFER
	100' RIVERFRONT PROTECTION AREA
	APPROXIMATE LIMIT OF EXISTING 100-YEAR FLOOD PLAIN
	CENTER LINE
	TYP. DIMENSION
	TYP. ARC DIMENSION
	TYP. RADIUS
	TYP. ANGLE DIMENSION

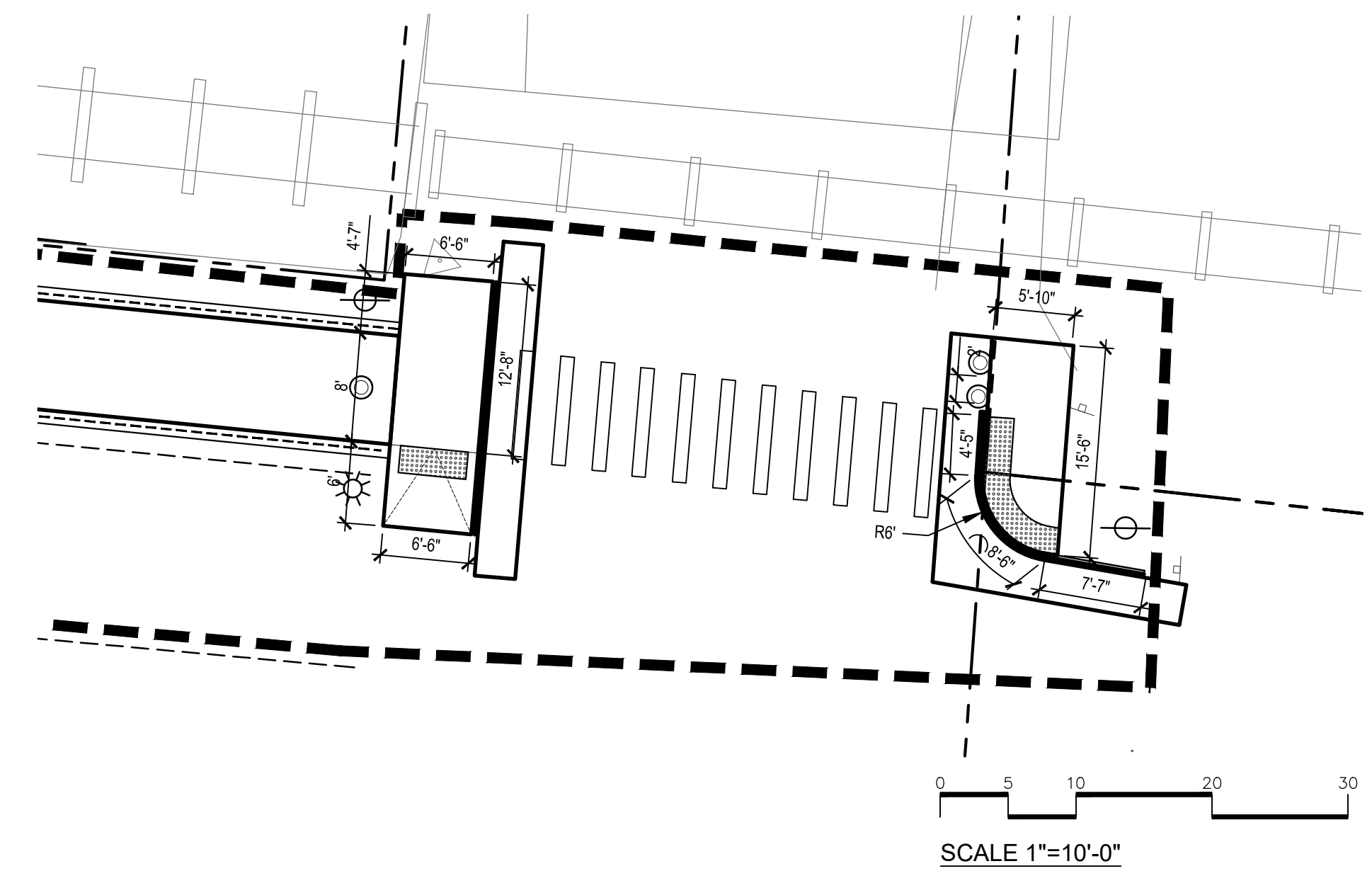

**1** HOWLEY STREET ENLARGEMENT PLAN  
SCALE: 1" = 10'-0"

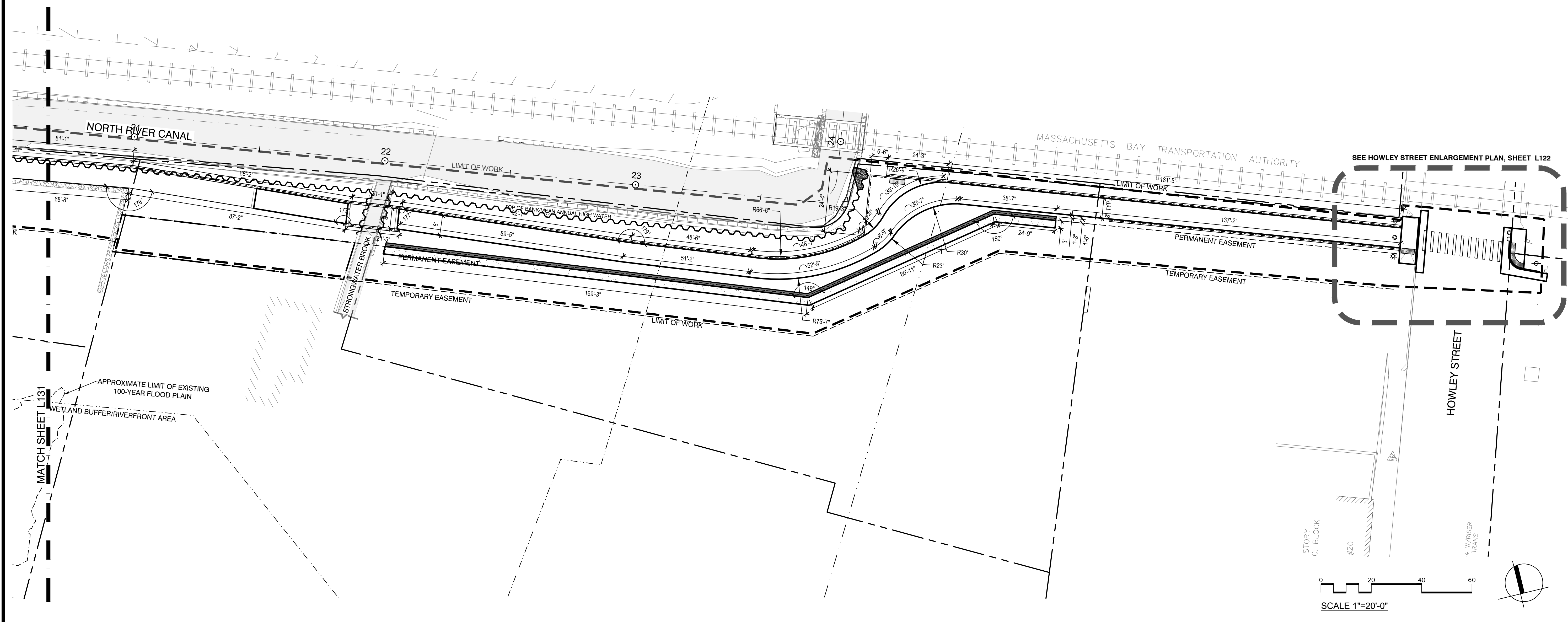

Project:  
PEABODY RIVERWALK  
RIVERWALK PARK

WALLIS STREET -  
CALLER STREET -  
HOWLEY STREET  
PEABODY, MA. 01960

**Weston & Sampson**  
WESTON & SAMPSON ENGINEERS, INC.  
85 DEVONSHIRE STREET, 3RD FLOOR  
BOSTON, MA 02109  
617-412-4480  
www.westonandsampson.com

Consultants:

Revisions:

No.	Date	Description



Issued For:  
**75% CONSTRUCTION DOCUMENTS**  
**- NOT FOR CONSTRUCTION -**

Scale: 1" = 10'

Date: APRIL 2021

Drawn By: FD, TY, SG

Reviewed By: CC

Approved By: CFR

W&S Project No.: ENG20-0145

W&S File No.:

Drawing Title:  
**LAYOUT PLAN**

Sheet Number:  
**L132**







**LEGEND**

	PROPERTY LINE		PROPOSED CONTOURS
	LIMIT OF WORK		PROPOSED SLOPE
	EASEMENTS		PROPOSED SPOT ELEVATION
	100' WETLAND BUFFER		HDPE PERFORATED DRAIN PIPE, DIAMETER VARIES
	200' RIVERFRONT PROTECTION AREA		GRADE BREAK
	APPROXIMATE LIMIT OF EXISTING 100-YEAR FLOOD PLAIN		HIGH POINT
	EXISTING DRAINAGE STRUCTURE. SEE UTILITIES PLAN		LOW POINT
	EXISTING CONTOURS		TOP OF WALL
	EXISTING SPOT ELEVATION		BOTTOM OF WALL
			ELEVATION

**GRADING & DRAINAGE NOTES**

- ALL WORK RELATING TO INSTALLATION, RENOVATION OR MODIFICATION OF WATER, UTILITY STORMWATER DRAINAGE AND/OR SEPTIC UTILITIES SHALL BE PERFORMED IN ACCORDANCE WITH THE STANDARDS OF THE CITY, AND STATE OF MASSACHUSETTS.
- THE CONTRACTOR SHALL VERIFY ALL GRADES ON THE GROUND AND REPORT ANY DISCREPANCIES IMMEDIATELY TO THE OWNER'S REPRESENTATIVE.
- ALL GRADING IS TO BE SMOOTH AND CONTINUOUS WHERE PROPOSED SURFACE MEETS EXISTING SURFACE. BLEND THE TWO PAVEMENTS AND ELIMINATE ROUGH SPOTS AND ABRUPT GRADE CHANGES AND MEET LINE AND GRADE OF EXISTING CONDITIONS WITH NEW IMPROVEMENTS.
- CONTRACTOR SHALL ENSURE ALL AREAS ARE PROPERLY PITCHED TO DRAIN, WITH NO SURFACE WATER PONDING OR PUDDLING.
- ALL NEW WALKWAYS MUST CONFORM TO CURRENT AMERICANS WITH DISABILITIES ACT (ADA), AND MASSACHUSETTS ARCHITECTURAL ACCESS BOARD (MAAB) REGULATIONS: WALKWAYS SHALL MAINTAIN A CROSS PITCH OF NOT MORE THAN ONE AND A HALF (1.5%) PERCENT AND THE RUNNING SLOPE (PARALLEL TO THE DIRECTION OF TRAVEL) BETWEEN 1% MIN. AND 4% MAX. ANY DISCREPANCIES NOT ALLOWING THIS TO OCCUR SHALL BE REPORTED TO THE OWNER'S REPRESENTATIVE PRIOR TO CONTINUING WORK.
- ALL UTILITY GRATES, COVERS OR OTHER SURFACE ELEMENTS INTENDED TO BE EXPOSED AT GRADE SHALL BE FLUSH WITH THE ADJACENT FINISHED GRADE AND ADJUSTED TO PROVIDE A SMOOTH TRANSITION AT ALL EDGES.
- THE CONTRACTOR SHALL CONFIRM AND/OR SET SUBGRADE ELEVATIONS TO ALLOW FOR POSITIVE DRAINAGE AND PROVIDE EROSION CONTROL DEVICES, STRUCTURES, MATERIALS AND CONSTRUCTION METHODS TO DIRECT SILT MIGRATION AWAY FROM DRAINAGE AND OTHER UTILITY SYSTEMS, PUBLIC/PRIVATE STREETS AND WORK AREAS. CLEAN BASINS REGULARLY AND AT THE END OF THE PROJECT.
- EXCAVATION REQUIRED WITHIN PROXIMITY OF KNOWN EXISTING UTILITY LINES SHALL BE DONE BY HAND. CONTRACTOR SHALL REPAIR ANY DAMAGE TO EXISTING UTILITY LINES OR STRUCTURES INCURRED DURING CONSTRUCTION OPERATIONS AT NO COST TO THE OWNER.
- WHERE NEW EARTHWORK MEETS EXISTING EARTHWORK, CONTRACTOR SHALL BLEND NEW EARTHWORK SMOOTHLY INTO EXISTING, PROVIDING VERTICAL CURVES OR ROUNDS AT ALL TOP AND BOTTOM OF SLOPES.
- WHERE A SPECIFIC LIMIT OF WORK LINE IS NOT OBVIOUS OR IMPLIED, BLEND GRADES TO EXISTING CONDITIONS WITHIN 5 FEET OF PROPOSED CONTOURS.
- RESTORE ALL DISTURBED AREAS AND LIMITS OF ALL REMOVALS TO LOAM AND SEED UNLESS OTHERWISE NOTED.
- SEE EARTHWORK SECTION OF SPECIFICATIONS FOR EXCAVATION AND FILLING PROCEDURES.

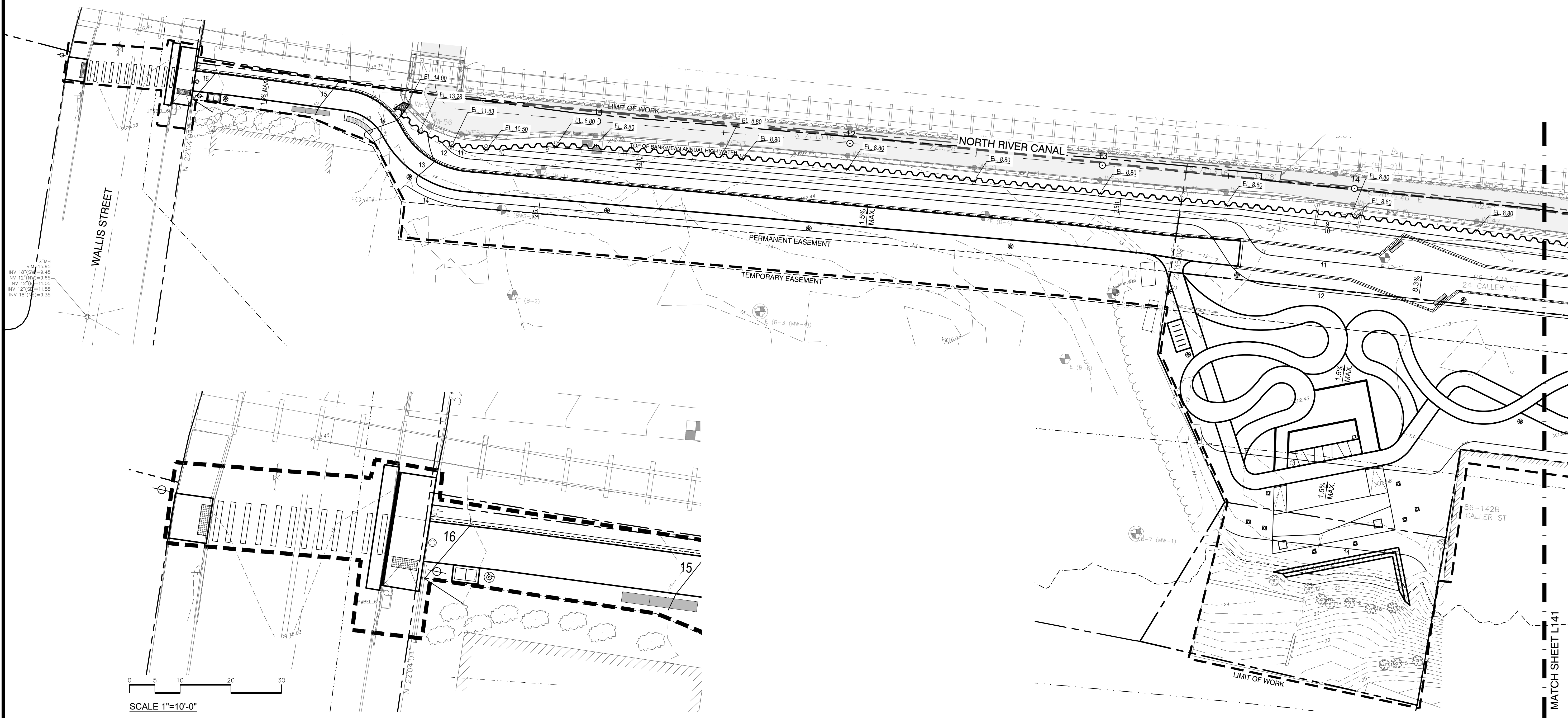

1 WALLIS ST ENLARGEMENT PLAN  
SCALE: 1" = 10'-0"

SCALE 1" = 20'-0"

MATCH SHEET L141

Project:  
PEABODY RIVERWALK  
RIVERWALK PARK

WALLIS STREET -  
CALLER STREET -  
HOWLEY STREET  
PEABODY, MA. 01960

**Weston & Sampson**  
WESTON & SAMPSON ENGINEERS, INC.  
85 DEVONSHIRE STREET, 3RD FLOOR  
BOSTON, MA 02109  
617-412-4480  
www.westonandsampson.com

Consultants:

--	--	--

Revisions:

No.	Date	Description

Seal:

Key Plan:

Issued For:

**75% CONSTRUCTION DOCUMENTS**  
**- NOT FOR CONSTRUCTION -**

Scale: 1" = 20'

Date: APRIL 2021

Drawn By: FD, TY, SG

Reviewed By: CC

Approved By: CFR

W&S Project No.: ENG20-0145

W&S File No.:

Drawing Title:

**GRADING AND DRAINAGE PLAN**

Sheet Number:

**L140**



**LEGEND**

- PROPERTY LINE
- LIMIT OF WORK
- EASEMENTS
- 100' WETLAND BUFFER
- 200' RIVERFRONT PROTECTION AREA
- APPROXIMATE LIMIT OF EXISTING 100-YEAR FLOOD PLAIN
- EXISTING DRAINAGE STRUCTURE. SEE UTILITIES PLAN
- EXISTING CONTOURS
- EXISTING SPOT ELEVATION
- 14 PROPOSED CONTOURS
- 15 PROPOSED CONTOURS
- 1.5% PROPOSED SLOPE
- 8.25 PROPOSED SPOT ELEVATION
- HDPE PERF. DRAIN PIPE
- HDPE PERFORATED DRAIN PIPE. DIAMETER VARIES
- GRADE BREAK
- HP HIGH POINT
- LP LOW POINT
- TW TOP OF WALL
- BW BOTTOM OF WALL
- EL ELEVATION

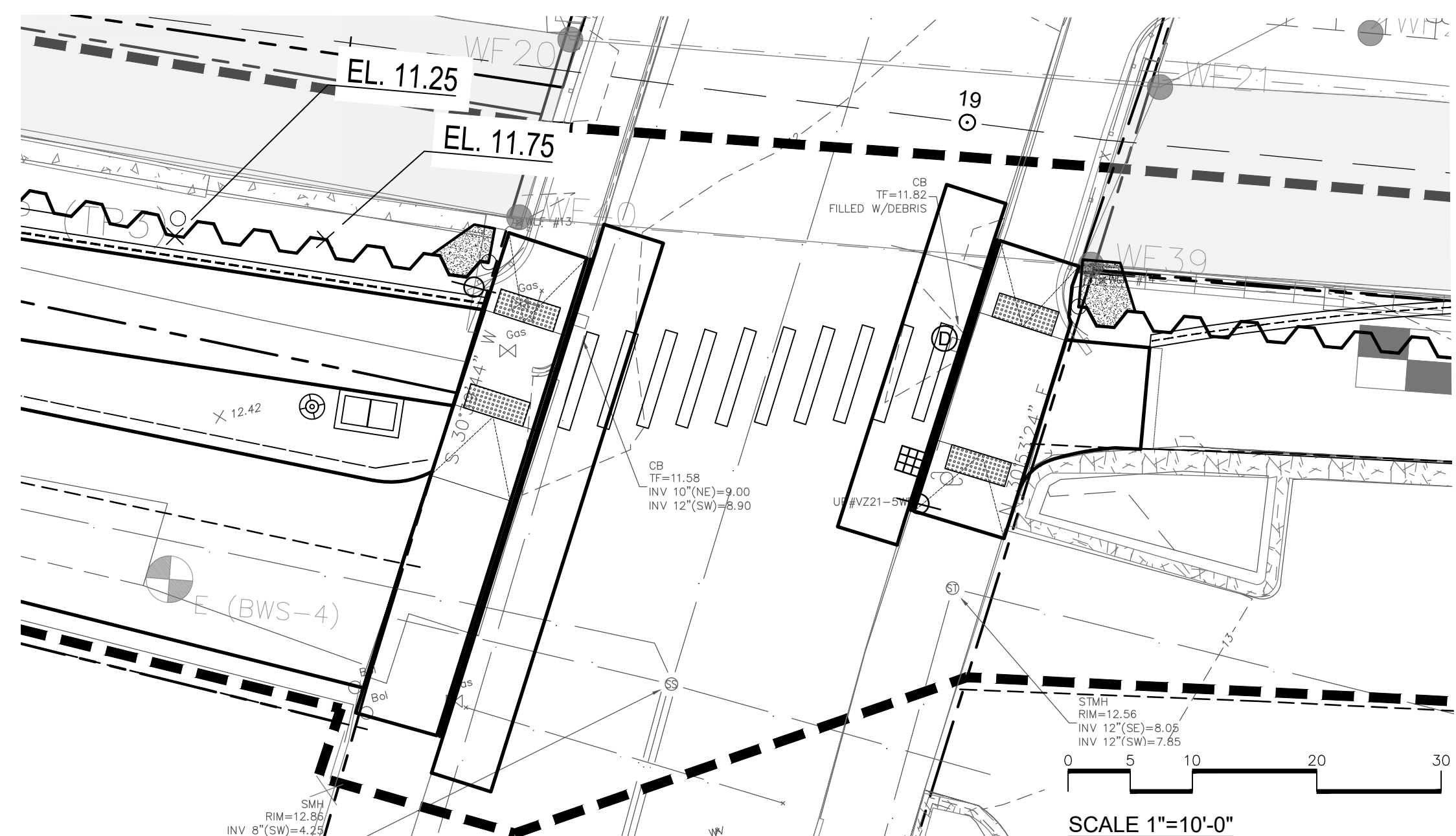

**1** CALLER STREET ENLARGEMENT PLAN  
SCALE: 1" = 10'-0"

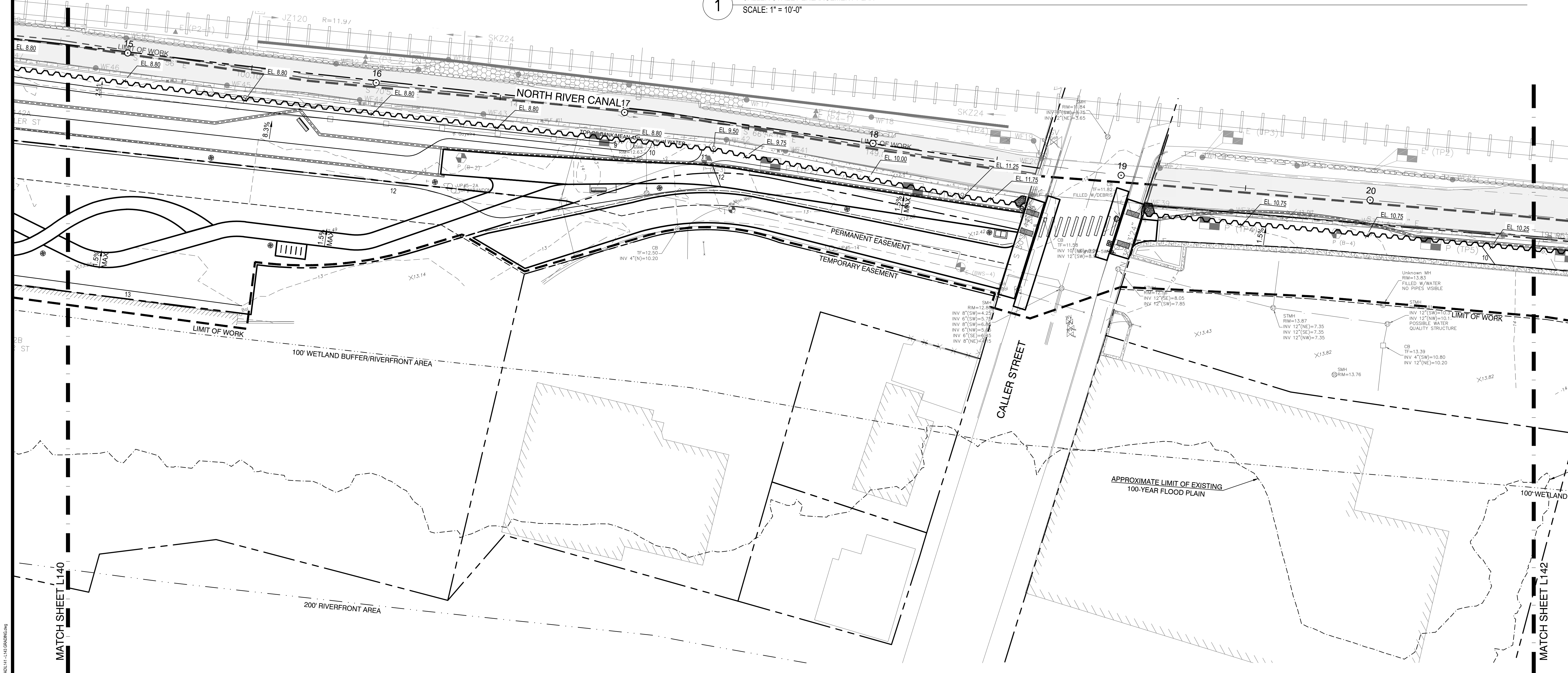

SCALE 1"=20'-0"

Project:  
PEABODY RIVERWALK  
RIVERWALK PARK

WALLIS STREET -  
CALLER STREET -  
HOWLEY STREET  
PEABODY, MA. 01960

**Weston & Sampson**  
WESTON & SAMPSON ENGINEERS, INC.  
85 DEVONSHIRE STREET, 3RD FLOOR  
BOSTON, MA 02109  
617-412-4480  
www.westonandsampson.com

Consultants:

Revisions:

No.	Date	Description

Seal:

Key Plan:

Issued For:

**75% CONSTRUCTION DOCUMENTS**  
**- NOT FOR CONSTRUCTION -**

Scale: 1" = 20'

Date: APRIL 2021

Drawn By: FD, TY, SG

Reviewed By: CC

Approved By: CFR

W&S Project No.: ENG20-0145

W&S File No.:

Drawing Title:

**GRADING AND DRAINAGE PLAN**

Sheet Number:

**L141**



**LEGEND**

	PROPERTY LINE		PROPOSED CONTOURS
	LIMIT OF WORK		PROPOSED SLOPE
	EASEMENTS		PROPOSED SPOT ELEVATION
	100' WETLAND BUFFER		
	200' RIVERFRONT PROTECTION AREA		HDPE PERF. DRAIN PIPE
	APPROXIMATE LIMIT OF EXISTING 100-YEAR FLOOD PLAIN		HDPE PERFORATED DRAIN PIPE, DIAMETER VARIES
	EXISTING DRAINAGE STRUCTURE. SEE UTILITIES PLAN		GRADE BREAK
			HIGH POINT
			LOW POINT
			TOP OF WALL
			BOTTOM OF WALL
			ELEVATION
	EXISTING CONTOURS		
	EXISTING SPOT ELEVATION		

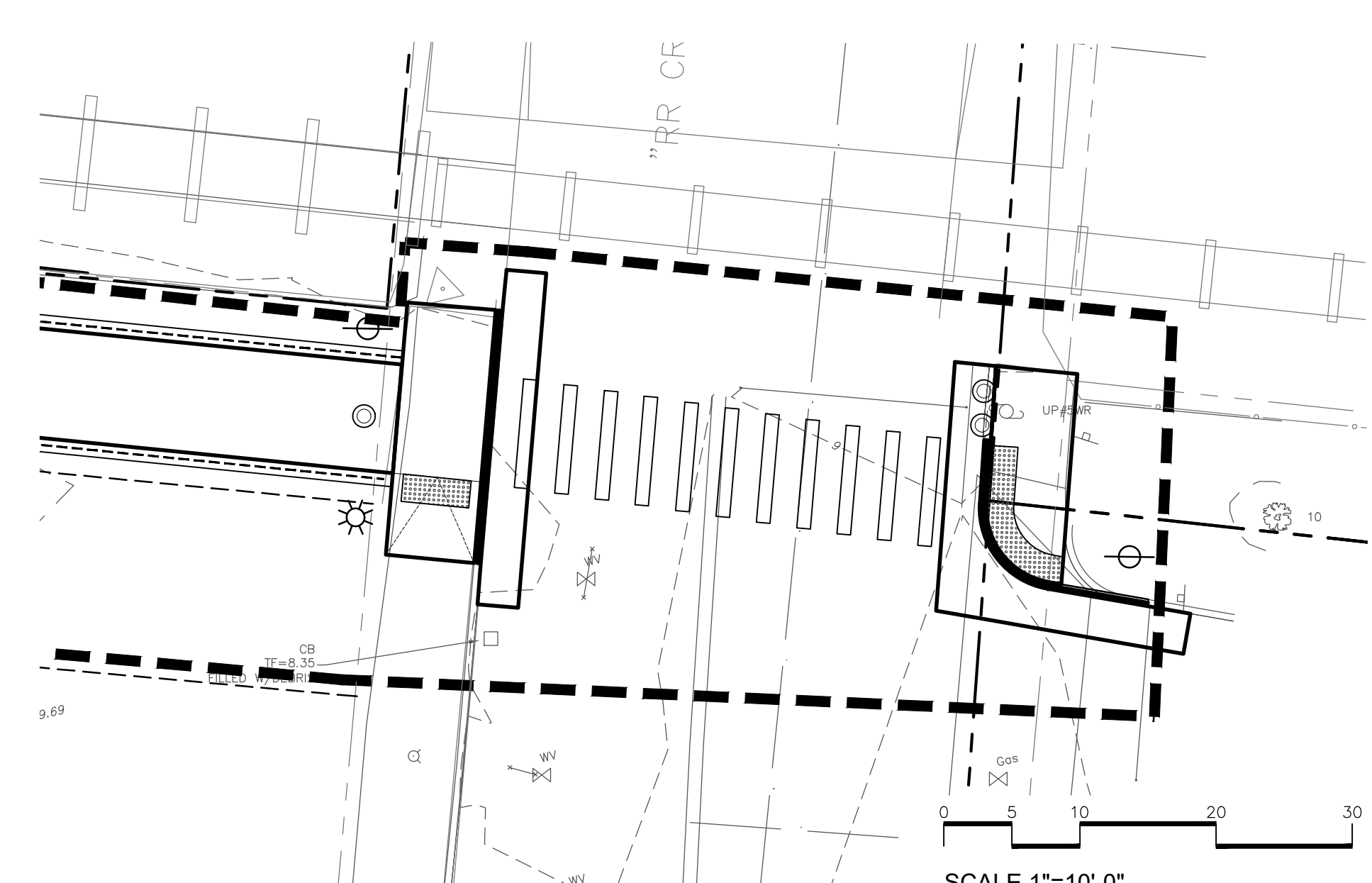

**1** HOWLEY STREET ENLARGEMENT PLAN  
SCALE: 1" = 10'-0"

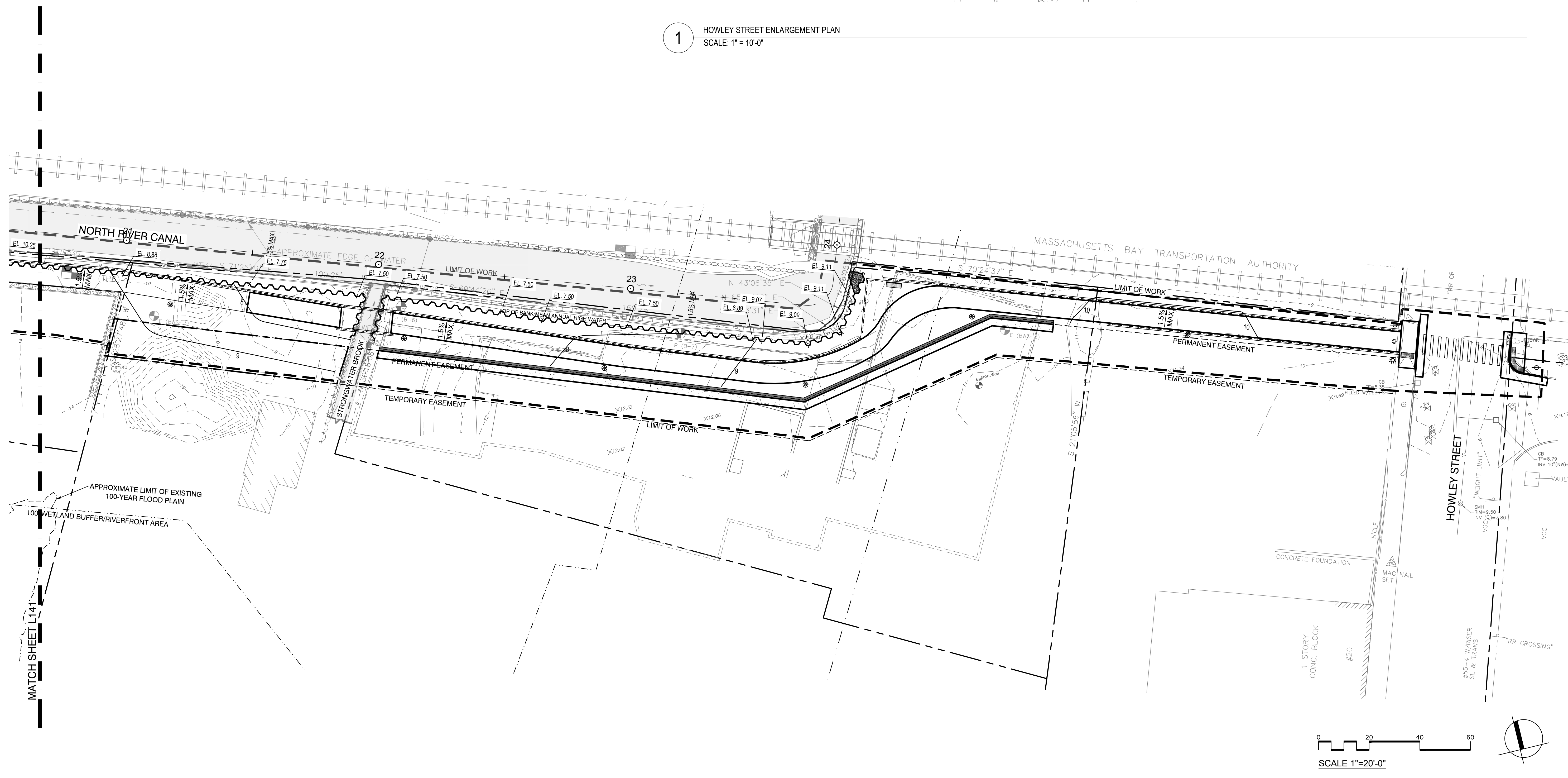

SCALE 1"=20'-0"

Project:  
**PEABODY RIVERWALK RIVERWALK PARK**  
  
 WALLIS STREET - CALLER STREET - HOWLEY STREET  
 PEABODY, MA. 01960

**Weston & Sampson**  
 WESTON & SAMPSON ENGINEERS, INC.  
 85 DEVONSHIRE STREET, 3RD FLOOR  
 BOSTON, MA 02109  
 617-412-4480  
 www.westonandsampson.com

Consultants:

--

Revisions:

No.	Date	Description

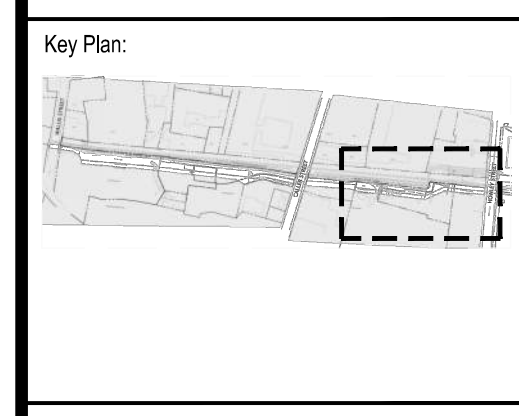

Issued For:  
**75% CONSTRUCTION DOCUMENTS**  
**- NOT FOR CONSTRUCTION -**

Scale: 1" = 20'

Date: APRIL 2021

Drawn By: FD, TY, SG

Reviewed By: CC

Approved By: CFR

W&S Project No.: ENG20-0145

W&S File No.:

Drawing Title:  
**GRADING AND DRAINAGE PLANS**

Sheet Number:  
**L142**



**LEGEND**

- PROPERTY LINE
- LIMIT OF WORK
- EASEMENTS
- 100' WETLAND BUFFER
- 100' RIVERFRONT PROTECTION AREA
- APPROXIMATE LIMIT OF EXISTING 100-YEAR FLOOD PLAIN
- SHEET PILE WALL
- NO-MOW SEED MIX

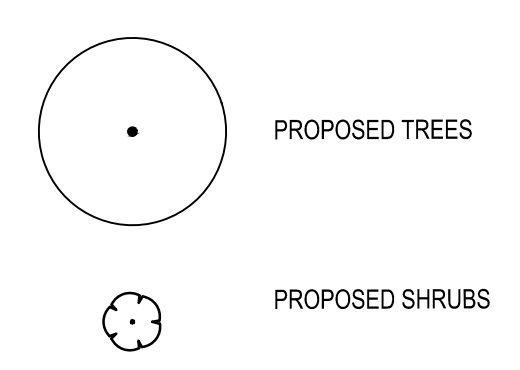

**PLANT SCHEDULE L150**

TREES	BOTANICAL NAME	COMMON NAME	SIZE	QTY	
AR	Acer rubrum	Red Maple	3" Cal.	7	
AS	Acer saccharum	Sugar Maple	---	6	
AC	Amelanchier canadensis 'Autumn Brilliance'	Autumn Brilliance Serviceberry	3" Cal.	4	
BN	Betula nigra 'Dura-Heat'	River Birch 'Dura-Heat'	3" Cal.	8	
BP	Betula papyrifera	Paper Birch	3" Cal.	2	
GT	Gleditsia triacanthos	Honey Locust	---	4	
MV	Magnolia virginiana	Sweet Bay	3" Cal.	4	
OV	Ostrya virginiana	American Hophornbeam	3" Cal.	3	
QA	Quercus alba	White Oak	3" Cal.	3	
QR	Quercus rubra	Red Oak	---	3	
SHRUBS	BOTANICAL NAME	COMMON NAME	SIZE	QTY	
CO	Cephalanthus occidentalis	Buttonbush	#2 Pot	1	
CA	Clethra alnifolia	Summersweet	#3 Pot	2	
CR	Cornus racemosa	Gray Dogwood	#3 Pot	4	
HV	Hamamelis virginiana	Common Witch Hazel	#3 Pot	4	
IV	Ilex verticillata 'Winter Red'	Winterberry 'Winter Red'	#3 Pot	6	
II	Itea virginica	Virginia Sweetspire	#2 Pot	5	
VL	Viburnum lentago	Nannyberry	#3 Pot	2	
SHRUB AREAS	BOTANICAL NAME	COMMON NAME	SIZE	SPACING	QTY
RA	Rhus aromatica 'Gro-Low'	Fragrant Sumac 'Gro-Low'	#3 Pot	36" o.c.	114
GROUND COVERS	BOTANICAL NAME	COMMON NAME	SIZE	SPACING	QTY
AM	Achillea millefolium	Common Yarrow	1 gal.	24" o.c.	196
CP	Carex pensylvanica	---	---	10" o.c.	2,207
DP	Dalea purpurea	---	---	24" o.c.	61
DU	Denistaedia punctilobula	Hay-scented Fern	---	30" o.c.	124
DT	Deschampsia cespitosa	Tufted Hair Grass	---	24" o.c.	71
EP	Echinacea purpurea	---	---	24" o.c.	130
EU	Eutrochium purpureum	---	---	48" o.c.	39
OC	Osmunda cinnamomea	---	---	30" o.c.	82
OR	Osmunda regalis	---	---	36" o.c.	55
SS	Schizachyrium scoparium	Little Bluestem	---	18" o.c.	94
SN	Solidago nemoralis	Blue Vervain	---	24" o.c.	181
VH	Verbena hastata	Blue Vervain	---	24" o.c.	44
SEEDING	BOTANICAL NAME	COMMON NAME	SIZE	SPACING	QTY
NMLM	No Mow Lawn Mix	---	---	---	12,764 sf

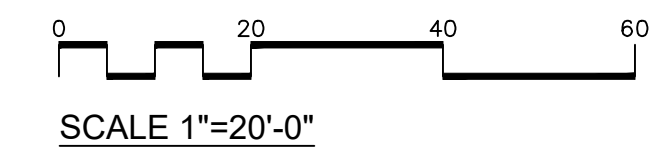
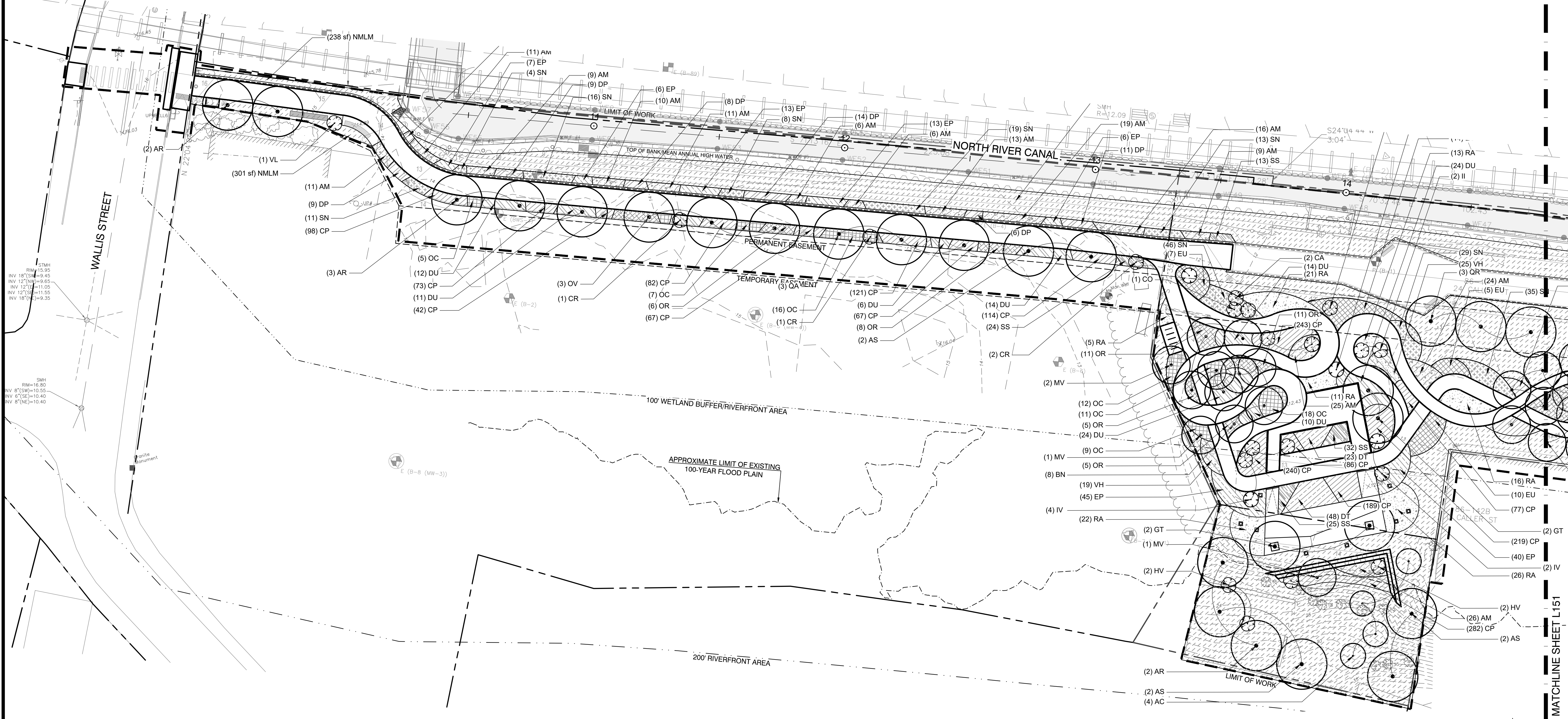

Project:  
**PEABODY RIVERWALK**  
 RIVERWALK PARK

WALLIS STREET -  
 CALLER STREET -  
 HOWLEY STREET  
 PEABODY, MA. 01960

**Weston & Sampson**  
 WESTON & SAMPSON ENGINEERS, INC.  
 85 DEVONSHIRE STREET, 3RD FLOOR  
 BOSTON, MA 02109  
 617-412-4480  
 www.westonandsampson.com

Consultants:

No.	Date	Description

Revisions:

No.	Date	Description

Seal:

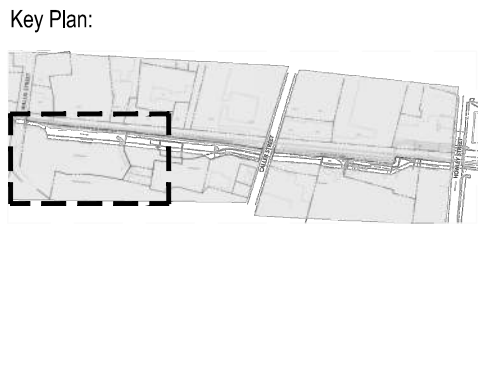

Issued For:  
**75% CONSTRUCTION DOCUMENTS**  
 - NOT FOR CONSTRUCTION -

Scale: 1" = 20'  
 Date: APRIL 2021  
 Drawn By: SG  
 Reviewed By: CC  
 Approved By:  
 W&S Project No.: ENG20-0145  
 W&S File No.:

Drawing Title:  
**PLANTING PLAN**

Sheet Number:  
**L150**



**LEGEND**

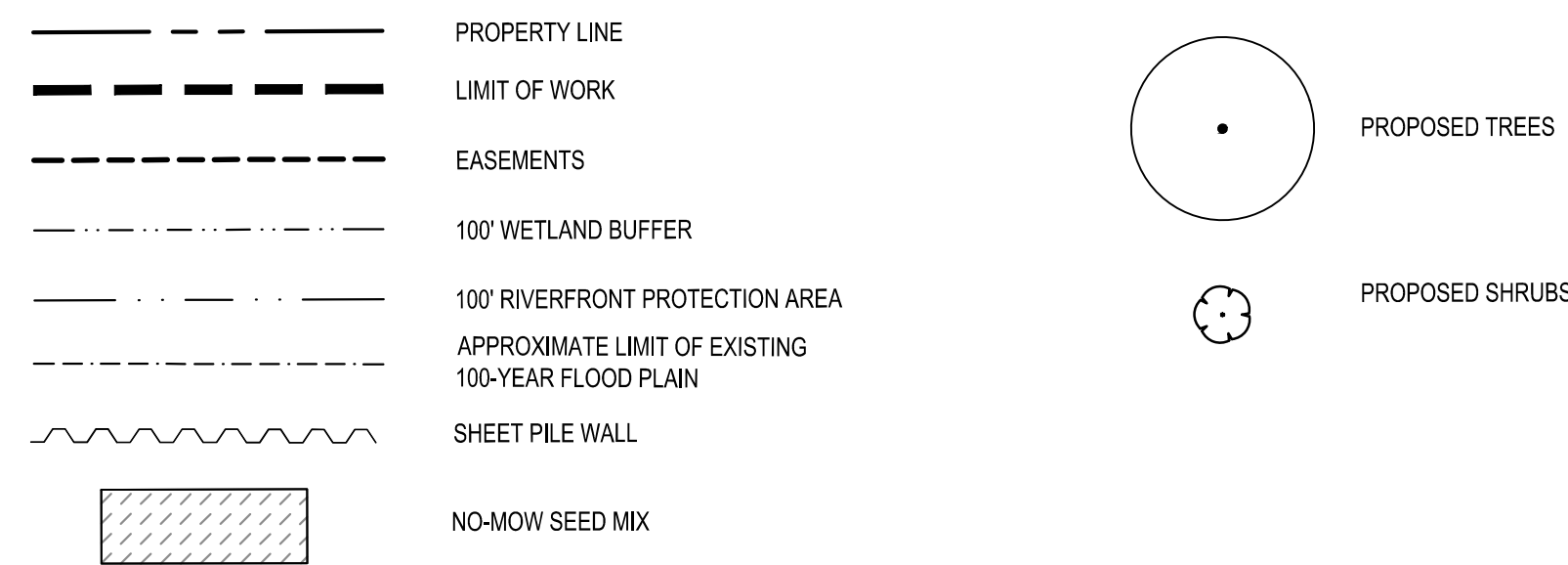

**PLANT SCHEDULE L151**

TREES	BOTANICAL NAME	COMMON NAME	SIZE	QTY	
AR	Acer rubrum	Red Maple	3" Cal.	2	
AS	Acer saccharum	Sugar Maple	---	3	
BP	Betula papyrifera	Paper Birch	3" Cal.	14	
GB	Ginkgo biloba	Maidenhair Tree	3" Cal.	2	
QA	Quercus alba	White Oak	3" Cal.	2	
SHRUB AREAS	BOTANICAL NAME	COMMON NAME	SIZE	SPACING	QTY
RA	Rhus aromatica "Gro-Low"	Fragrant Sumac "Gro-Low"	#3 Pot	36" o.c.	36
GROUND COVERS	BOTANICAL NAME	COMMON NAME	SIZE	SPACING	QTY
DU	Dennstaedtia punctilobula	Hay-scented Fern	---	30" o.c.	25
OC	Osmunda cinnamomea	---	---	30" o.c.	27
OR	Osmunda regalis	---	---	36" o.c.	30
SEEDING	BOTANICAL NAME	COMMON NAME	SIZE	SPACING	QTY
NMLM	No Mow Lawn Mix	---	---	---	8,777 sf

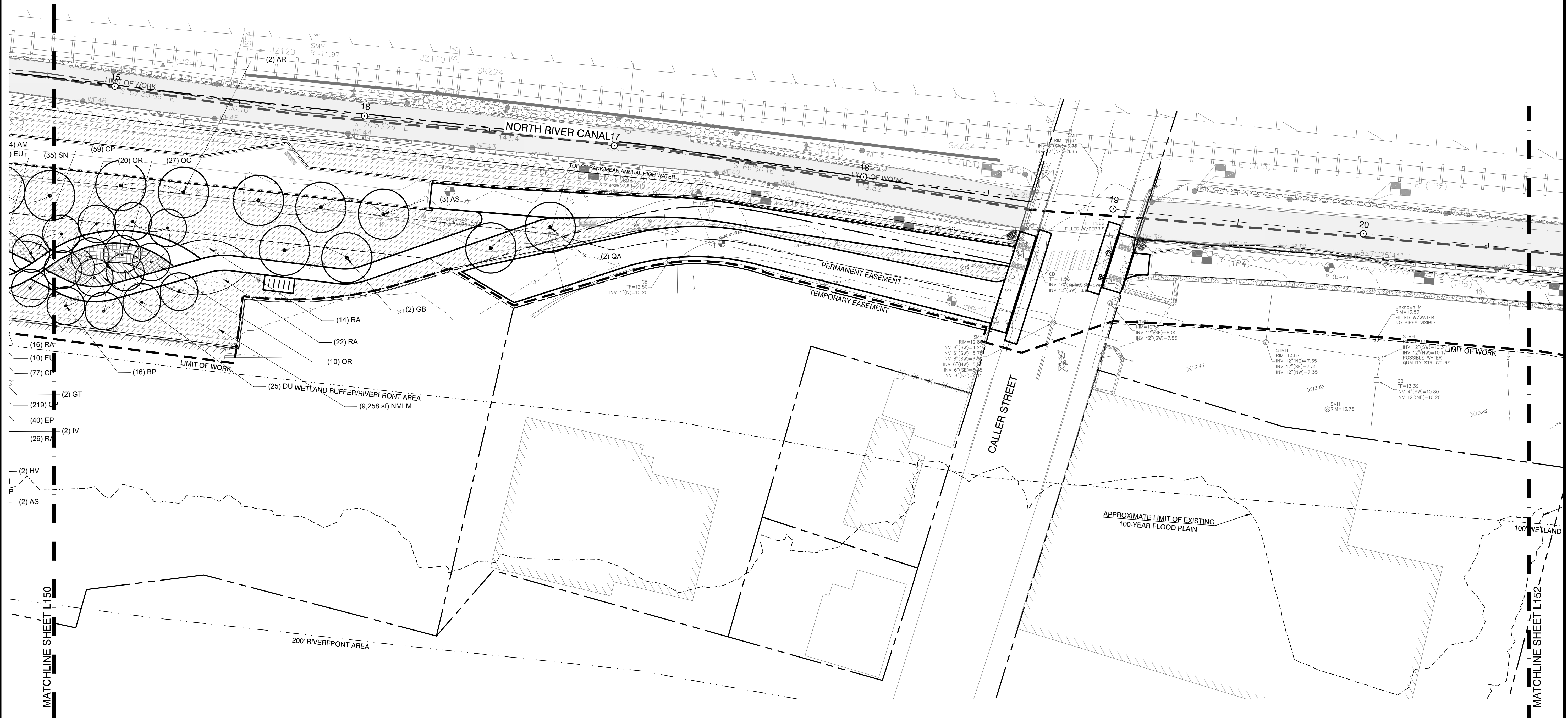

Project:  
PEABODY RIVERWALK  
RIVERWALK PARK

WALLIS STREET -  
CALLER STREET -  
HOWLEY STREET  
PEABODY, MA. 01960

**Weston & Sampson**  
WESTON & SAMPSON ENGINEERS, INC.  
85 DEVONSHIRE STREET, 3RD FLOOR  
BOSTON, MA 02109  
617-412-4480  
www.westonandsampson.com

Consultants:

Revisions:

No.	Date	Description

Seal:

Key Plan:

Issued For:  
**75% CONSTRUCTION DOCUMENTS**  
**- NOT FOR CONSTRUCTION -**

Scale: 1" = 20'

Date: APRIL 2021  
Drawn By: FD, TY, SG  
Reviewed By: CC  
Approved By: CFR

W&S Project No.: ENG20-0145  
W&S File No.:

Drawing Title:  
**PLANTING PLAN**

Sheet Number:  
**L151**

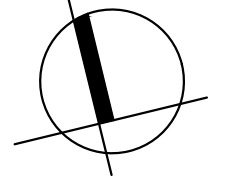
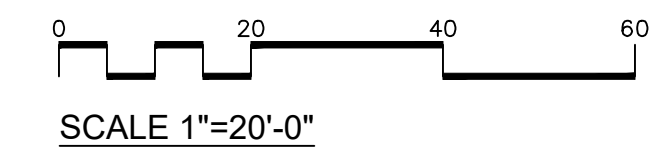

PEABODY RIVERWALK PARK CONSTRUCTION DOCUMENTS - 10/15/2020



**LEGEND**

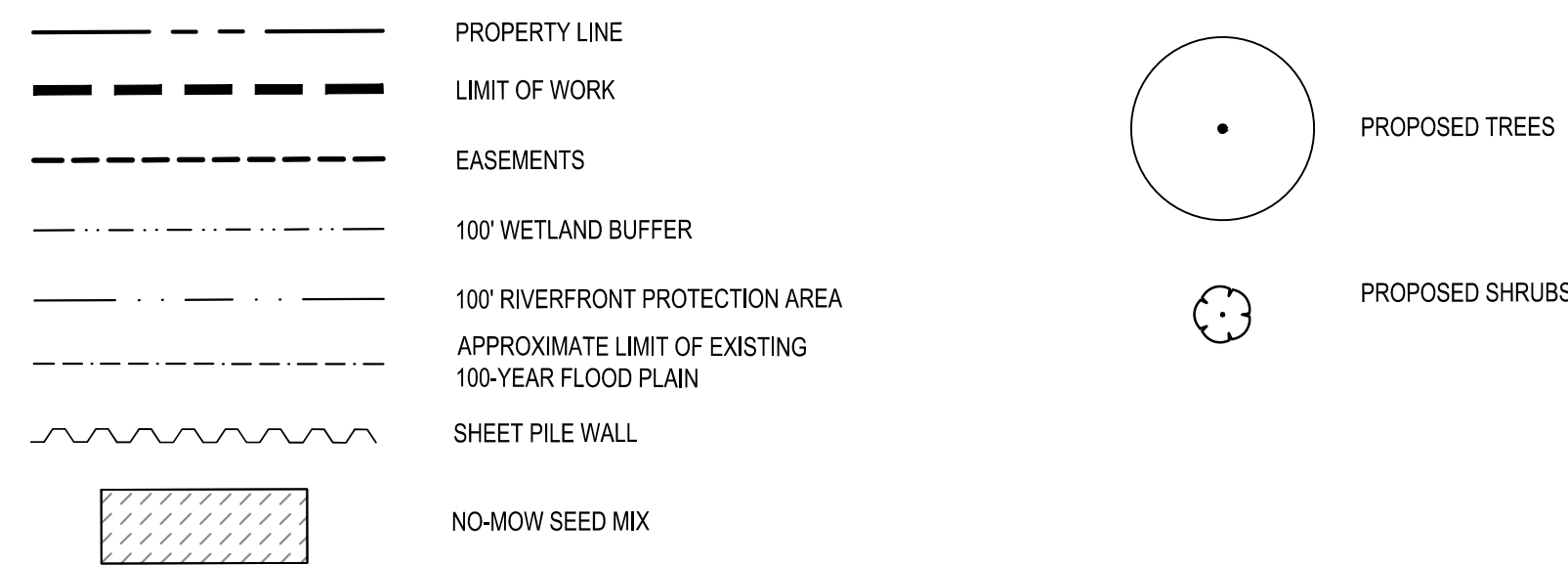

**PLANT SCHEDULE L152**

TREES	BOTANICAL NAME	COMMON NAME	SIZE	QTY
AR	Acer rubrum	Red Maple	3" Cal.	3
NS	Nyssa sylvatica	Sour Gum	3" Cal.	4

SEEDING	BOTANICAL NAME	COMMON NAME	SIZE	SPACING	QTY
NMLM	No Mow Lawn Mix		---		4,031 sf

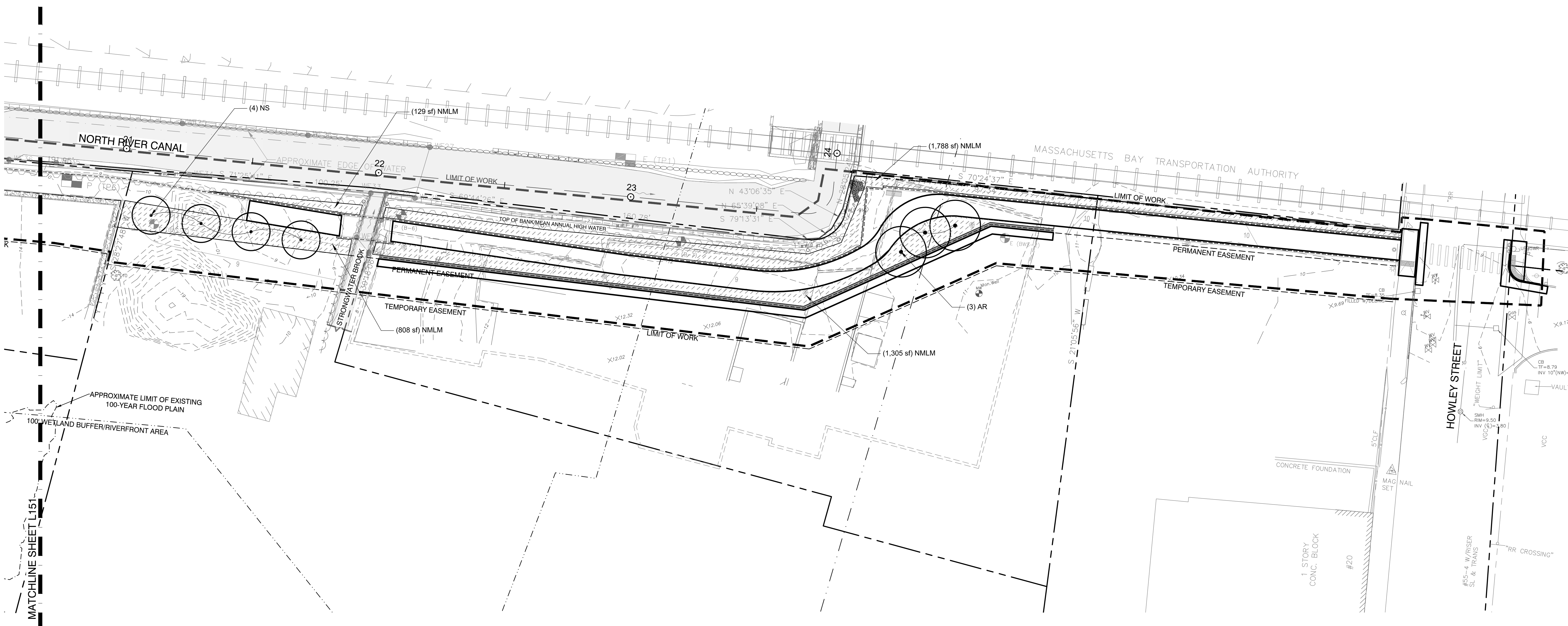

MATCHLINE SHEET L151

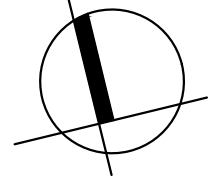
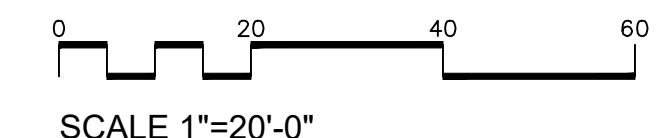

Project:  
**PEABODY RIVERWALK RIVERWALK PARK**

WALLIS STREET -  
 CALLER STREET -  
 HOWLEY STREET  
 PEABODY, MA. 01960

**Weston & Sampson**  
 WESTON & SAMPSON ENGINEERS, INC.  
 85 DEVONSHIRE STREET, 3RD FLOOR  
 BOSTON, MA 02109  
 617-412-4480  
 www.westonandsampson.com

Consultants:

Revisions:

No.	Date	Description

Seal:

Key Plan:

Issued For:  
**75% CONSTRUCTION DOCUMENTS**  
**- NOT FOR CONSTRUCTION -**

Scale: 1" = 20'  
 Date: APRIL 2021  
 Drawn By: TY, SG  
 Reviewed By: CC  
 Approved By: CFR

W&S Project No.: ENG20-0145  
 W&S File No.:

Drawing Title:  
**PLANTING PLAN**

Sheet Number:  
**L152**







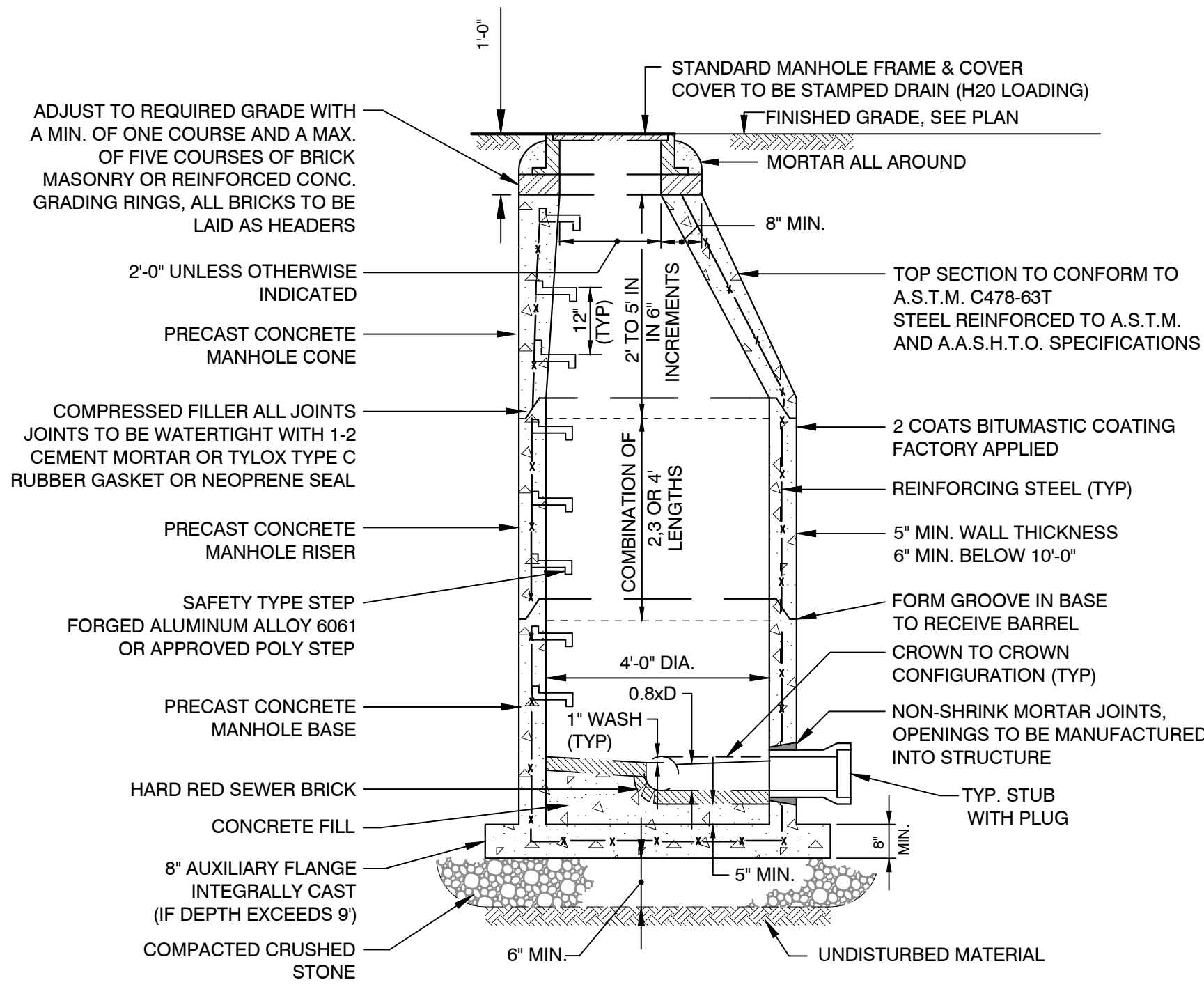

**1** DRAIN MANHOLE  
SCALE: N.T.S.

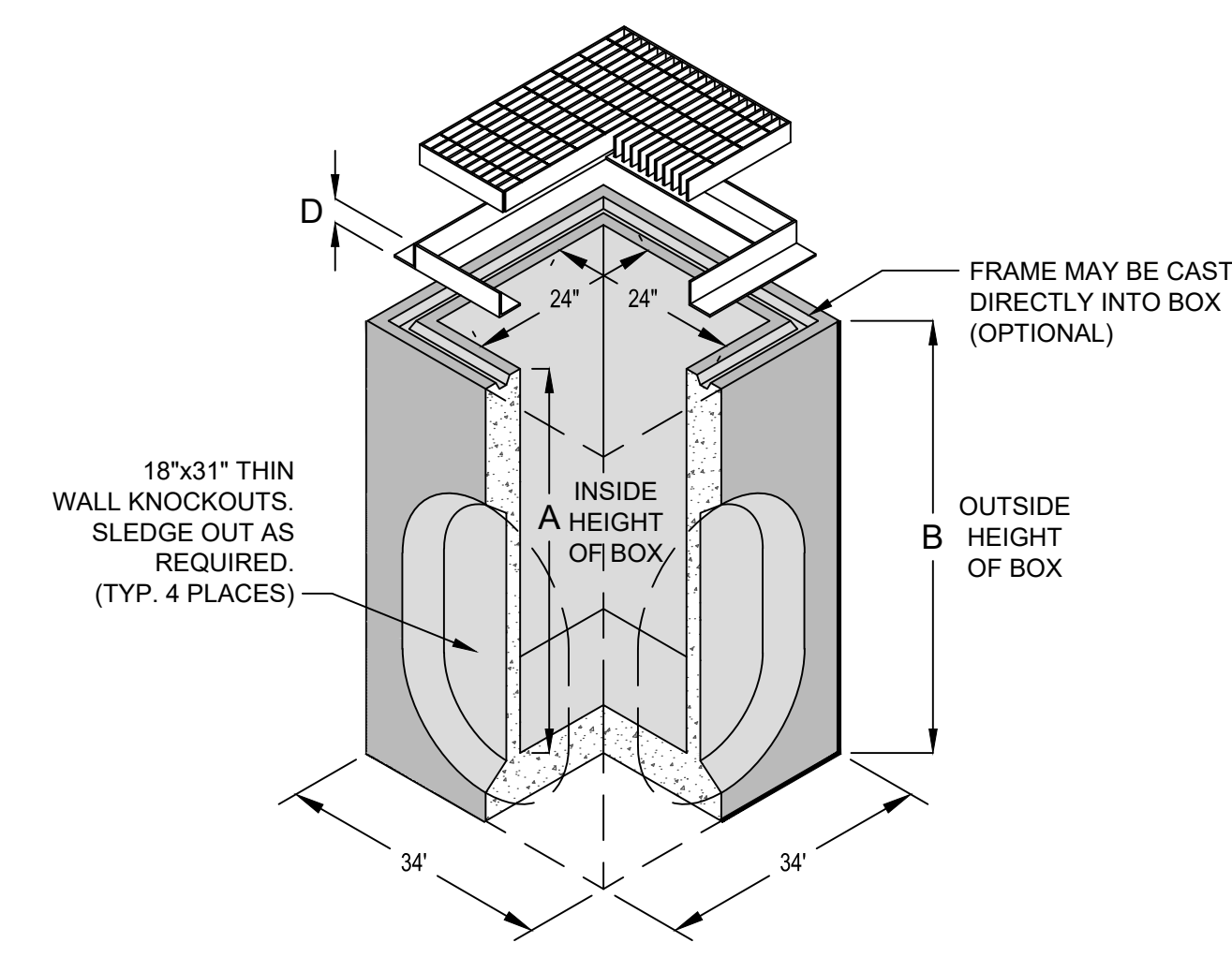

DROP INLET			
MODEL NO.	A	B	* WEIGHT
DI242436	36"	42"	1900 LBS.

\* BOX ONLY

FRAME AND GRATE			
MODEL NO.	RATING	D	WEIGHT
SG2424-DIT	TRAFFIC	3"	120 LBS.

**2** DROP INLET  
SCALE: N.T.S.

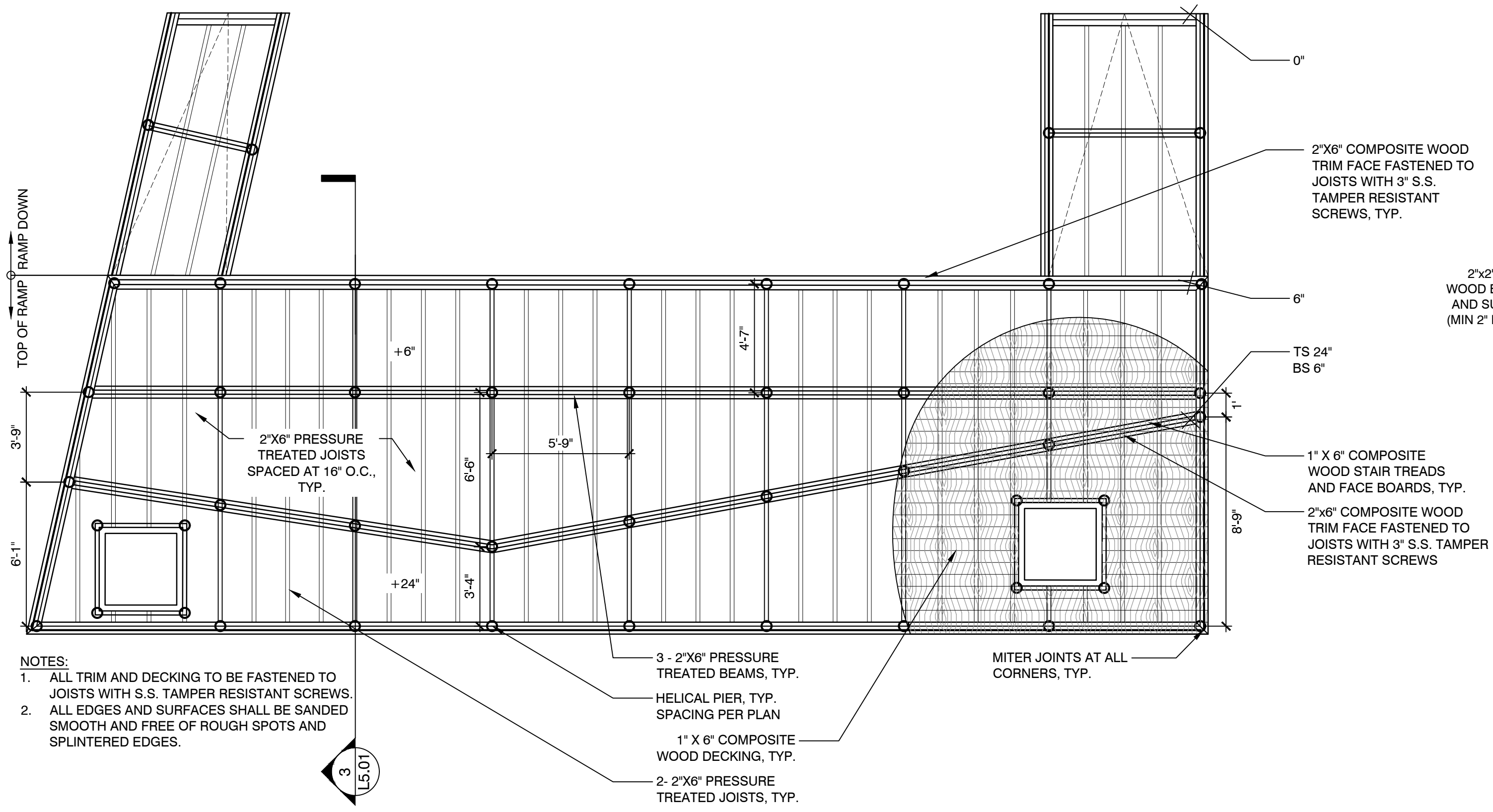

- NOTES:
- ALL TRIM AND DECKING TO BE FASTENED TO JOISTS WITH S.S. TAMPER RESISTANT SCREWS.
  - ALL EDGES AND SURFACES SHALL BE SANDED SMOOTH AND FREE OF ROUGH SPOTS AND SPLINTERED EDGES.

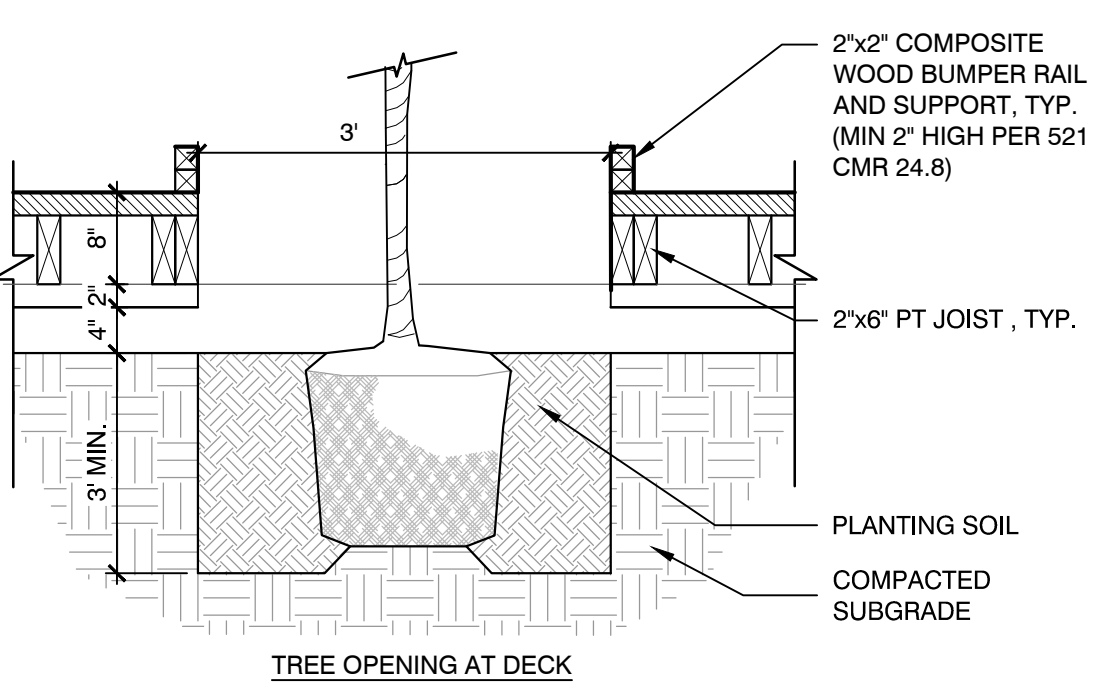
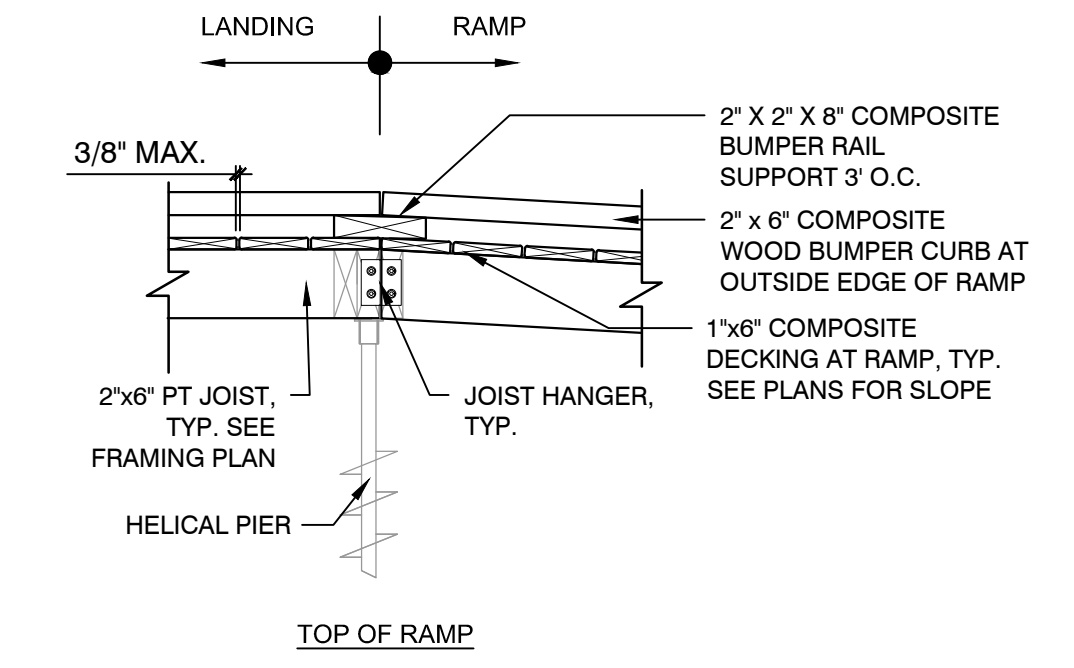
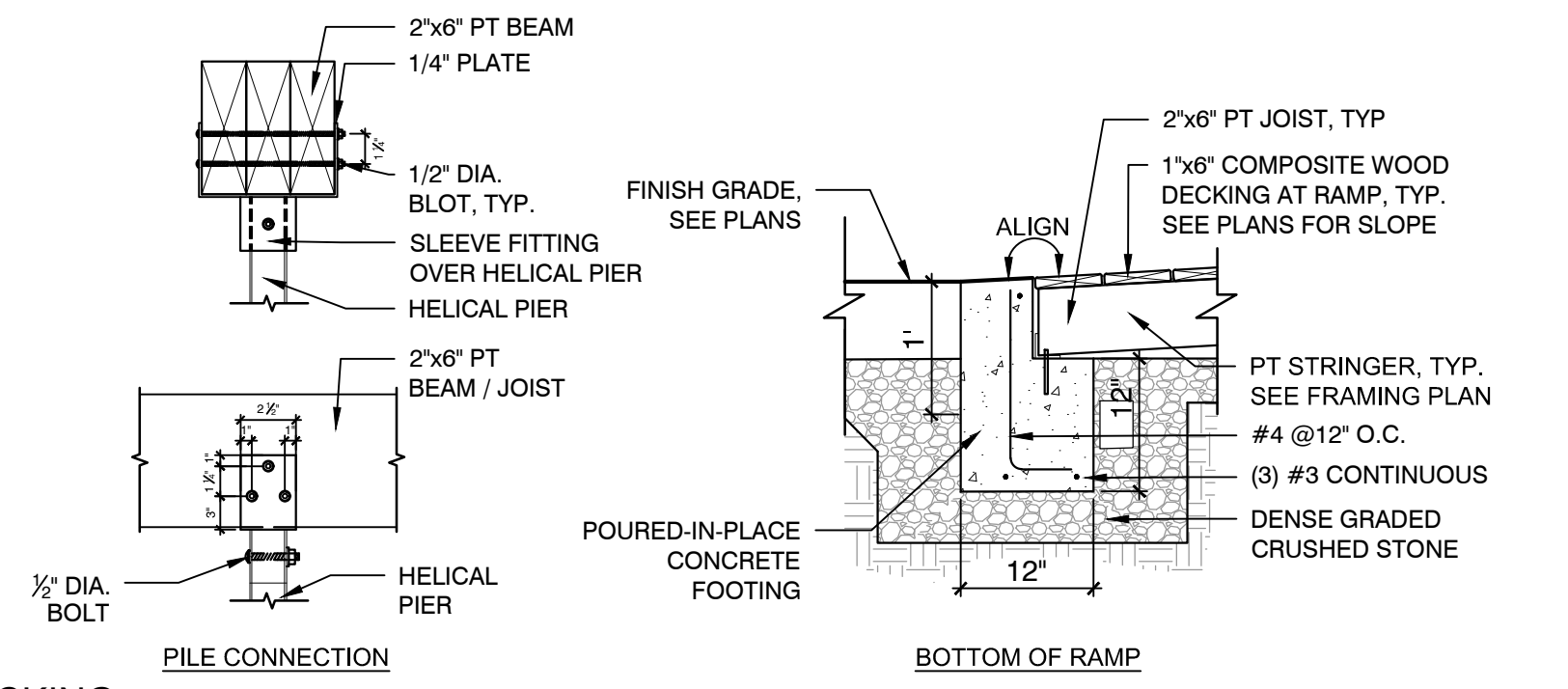
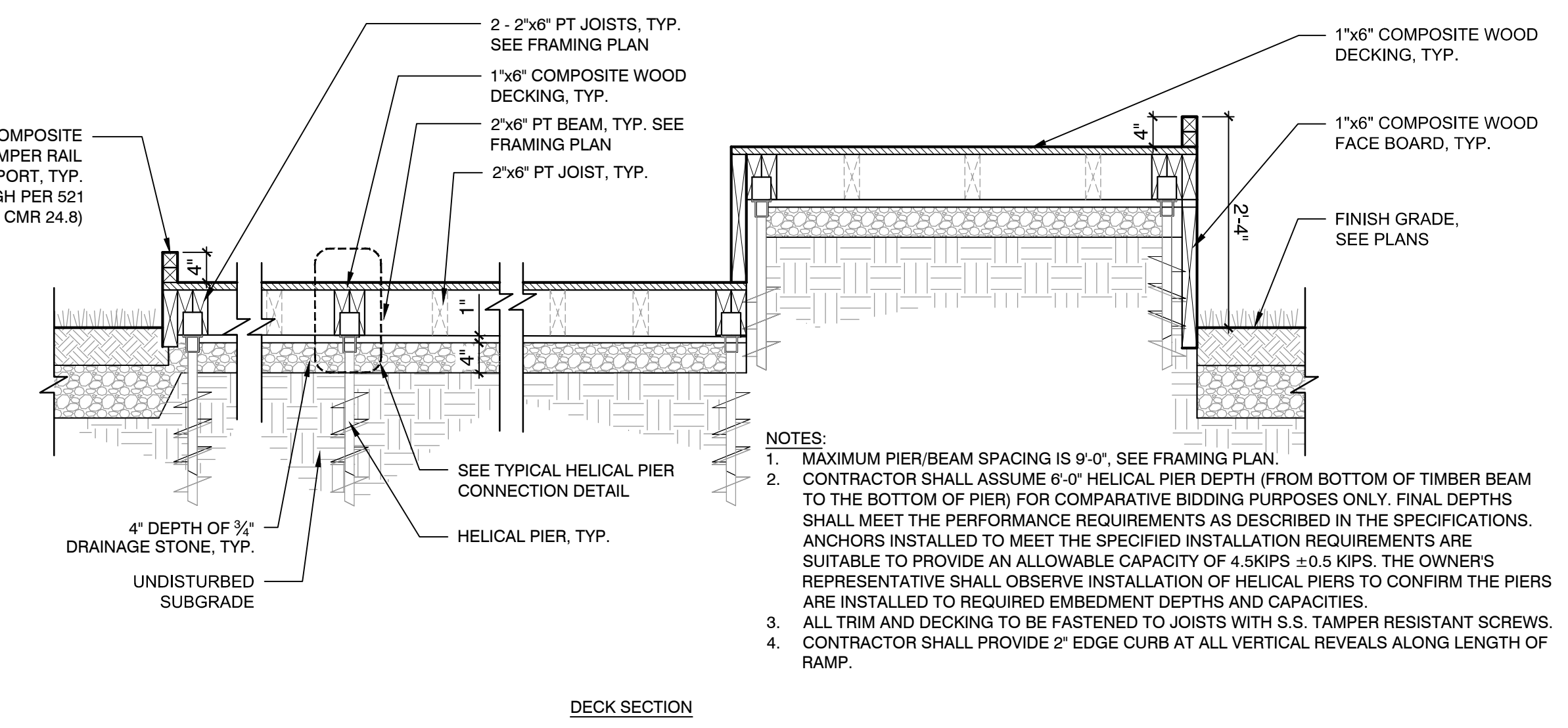

**3** WOOD DECKING  
SCALE: N.T.S.

Revisions:

No.	Date	Description

Seal:

Key Plan:

Issued For:  
**75% CONSTRUCTION DOCUMENTS**  
- NOT FOR CONSTRUCTION -

Scale: N.T.S.  
Date: APRIL 2021  
Drawn By: FD, TY, SG  
Reviewed By: CC  
Approved By: CFR  
W&S Project No.: ENG20-0145  
W&S File No.:



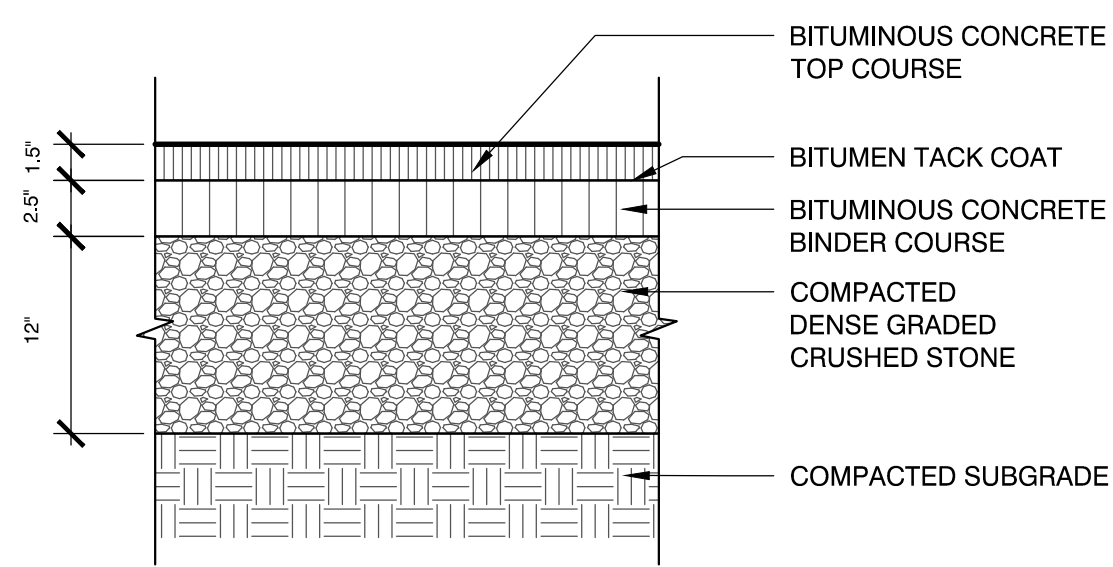

NOTES:  
1. CONTRACTOR TO PROVIDE SMOOTH TRANSITION WHERE NEW PAVEMENT ABUTS EXISTING PAVEMENT, TYP.

**1** VEHICULAR BITUMINOUS CONCRETE PAVEMENT  
SCALE: N.T.S.

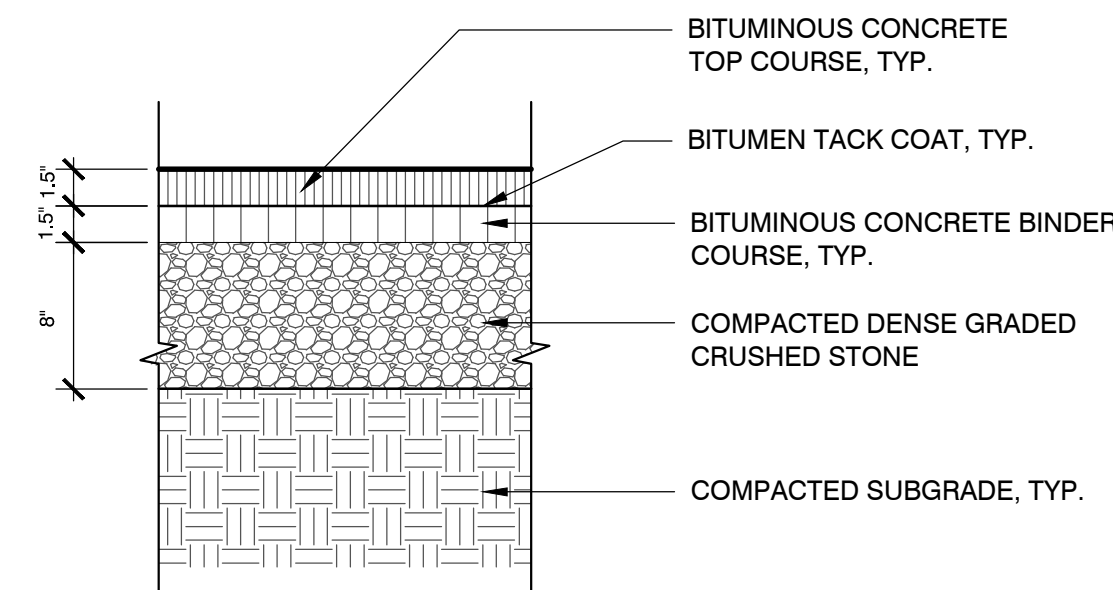

NOTE:  
1. CONTRACTOR TO PROVIDE SMOOTH TRANSITION WHERE NEW PAVEMENT ABUTS EXISTING PAVEMENT, TYP.

**2** PEDESTRIAN BITUMINOUS CONCRETE PAVEMENT  
SCALE: N.T.S.

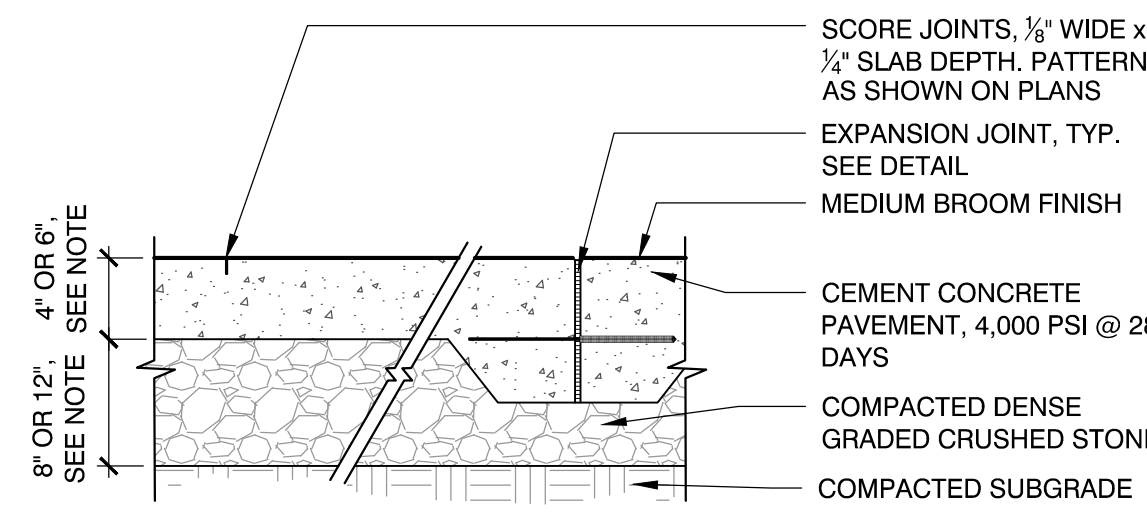

CAST-IN-PLACE CONCRETE PAVEMENT  
CAST-IN-PLACE CONCRETE NOTES:  
1. PEDESTRIAN CAST-IN-PLACE CONCRETE PAVEMENT TO BE 4\"/>

**3** CIP CONCRETE PAVEMENT  
SCALE: N.T.S.

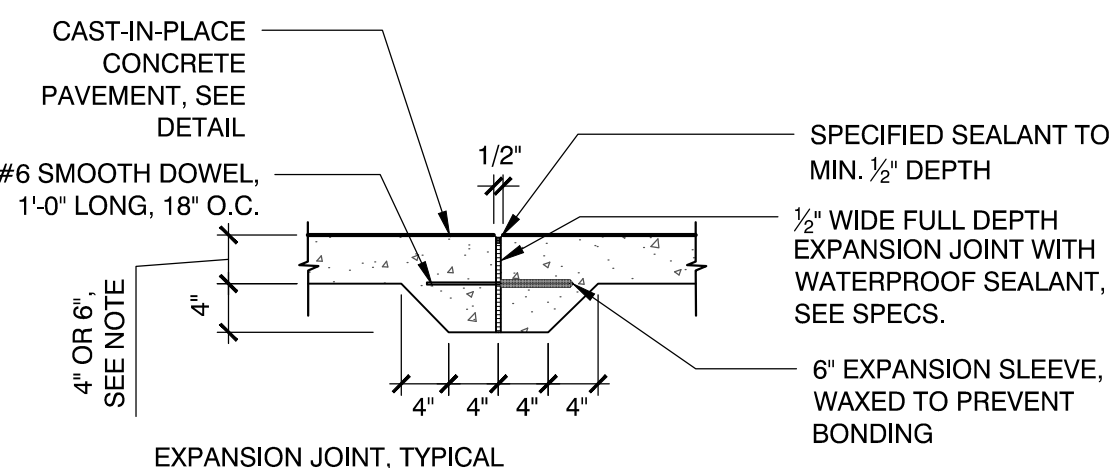

EXPANSION JOINT, TYPICAL  
EXPANSION JOINT INSTALLATION NOTES:  
1. DOWEL IS TYPICAL AT ALL EXPANSION JOINTS (18\"/>

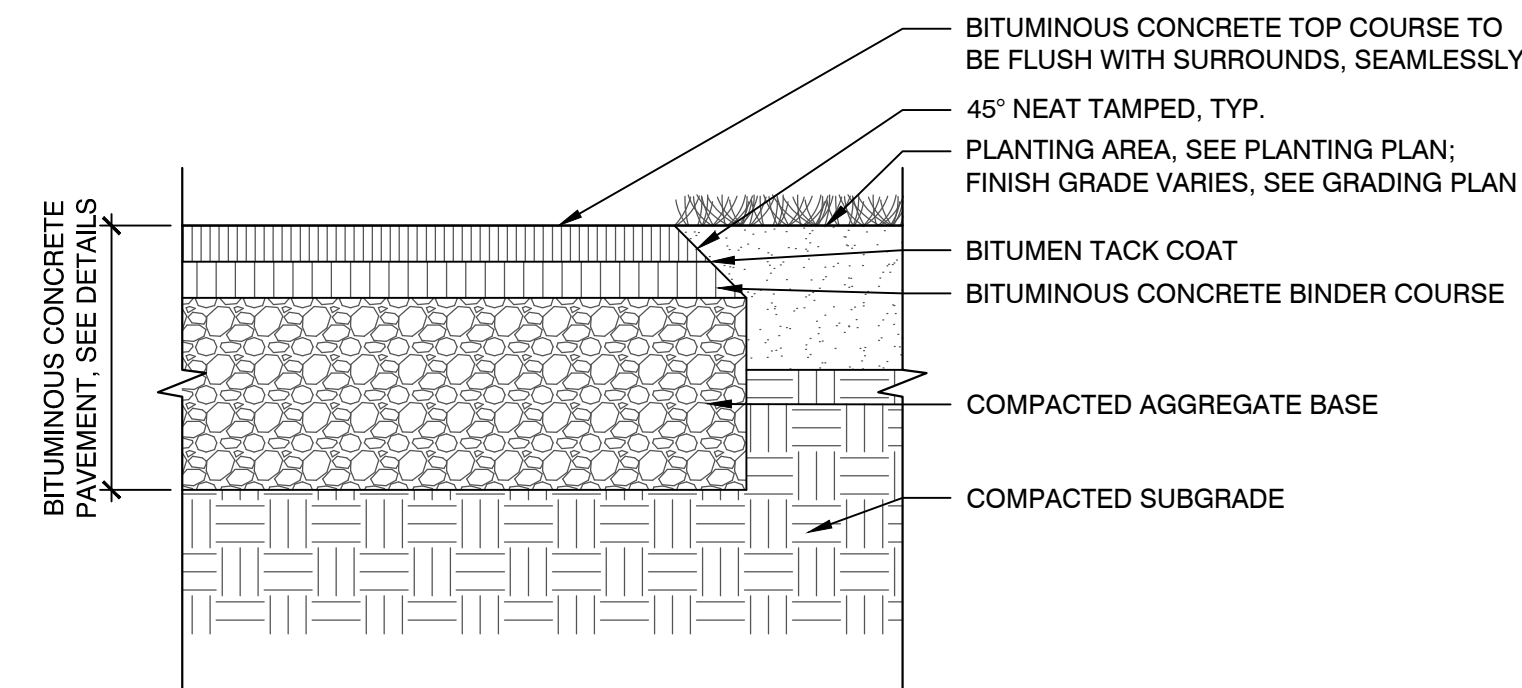

**4** BITUMINOUS CONCRETE AT PLANTING  
SCALE: N.T.S.

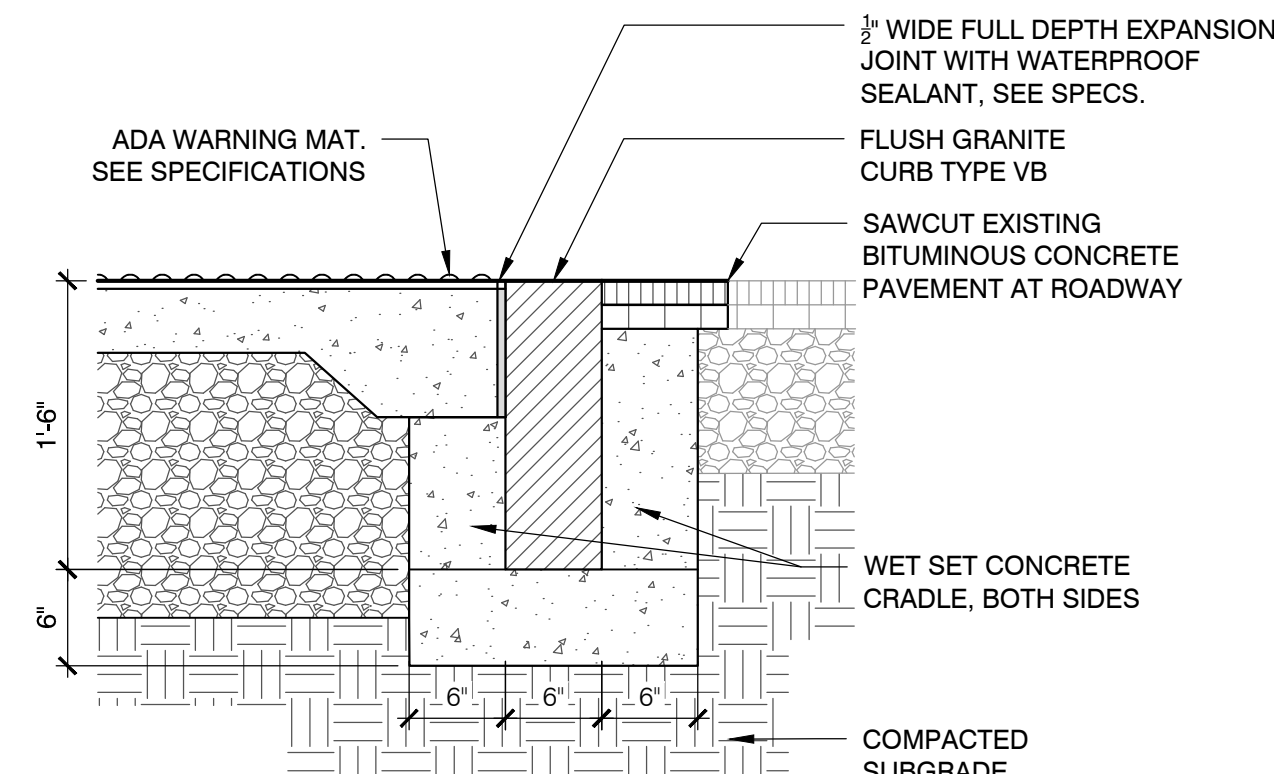

**5** FLUSH GRANITE CURB WITH ADA DETECTABLE WARNING MAT  
SCALE: N.T.S.

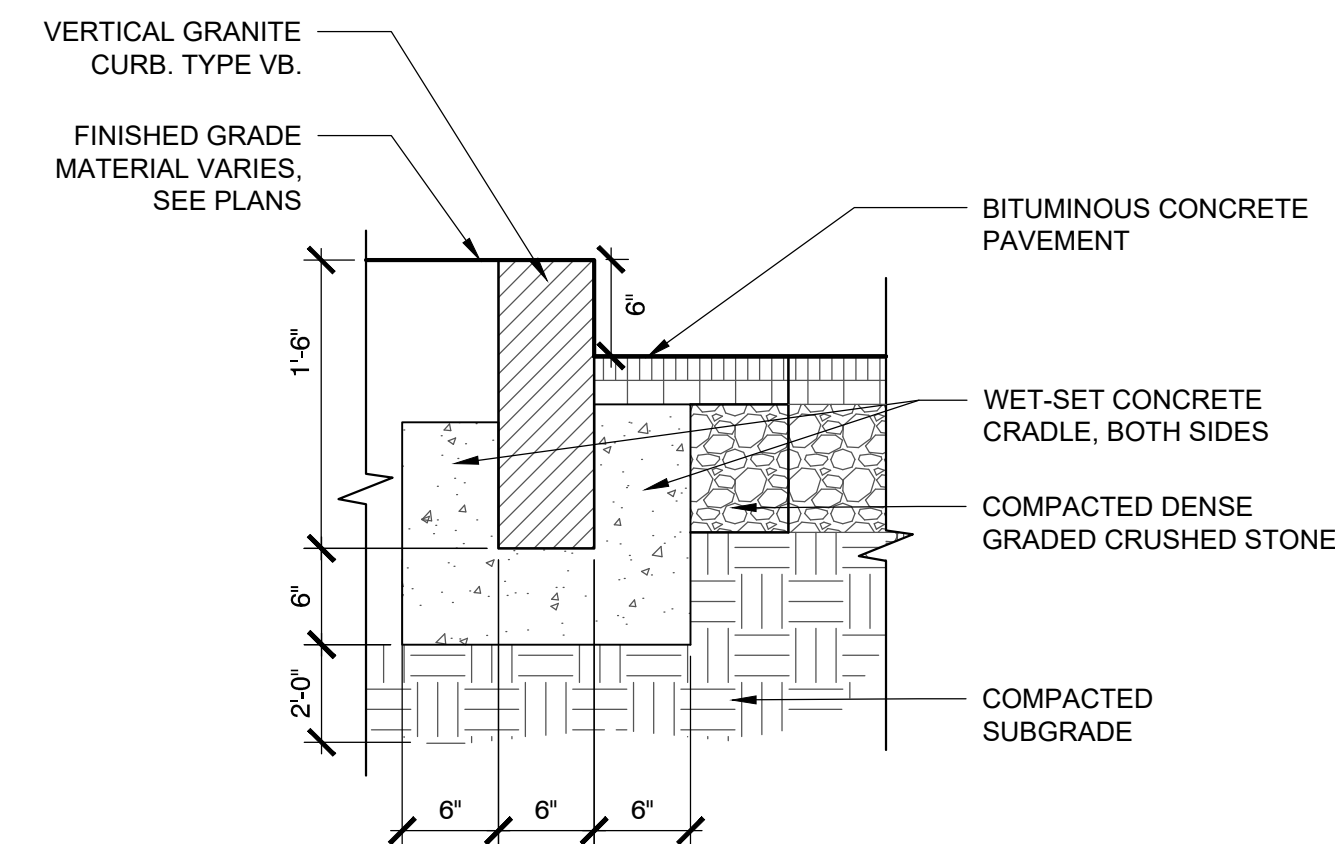

**6** VERTICAL GRANITE CURB  
SCALE: N.T.S.

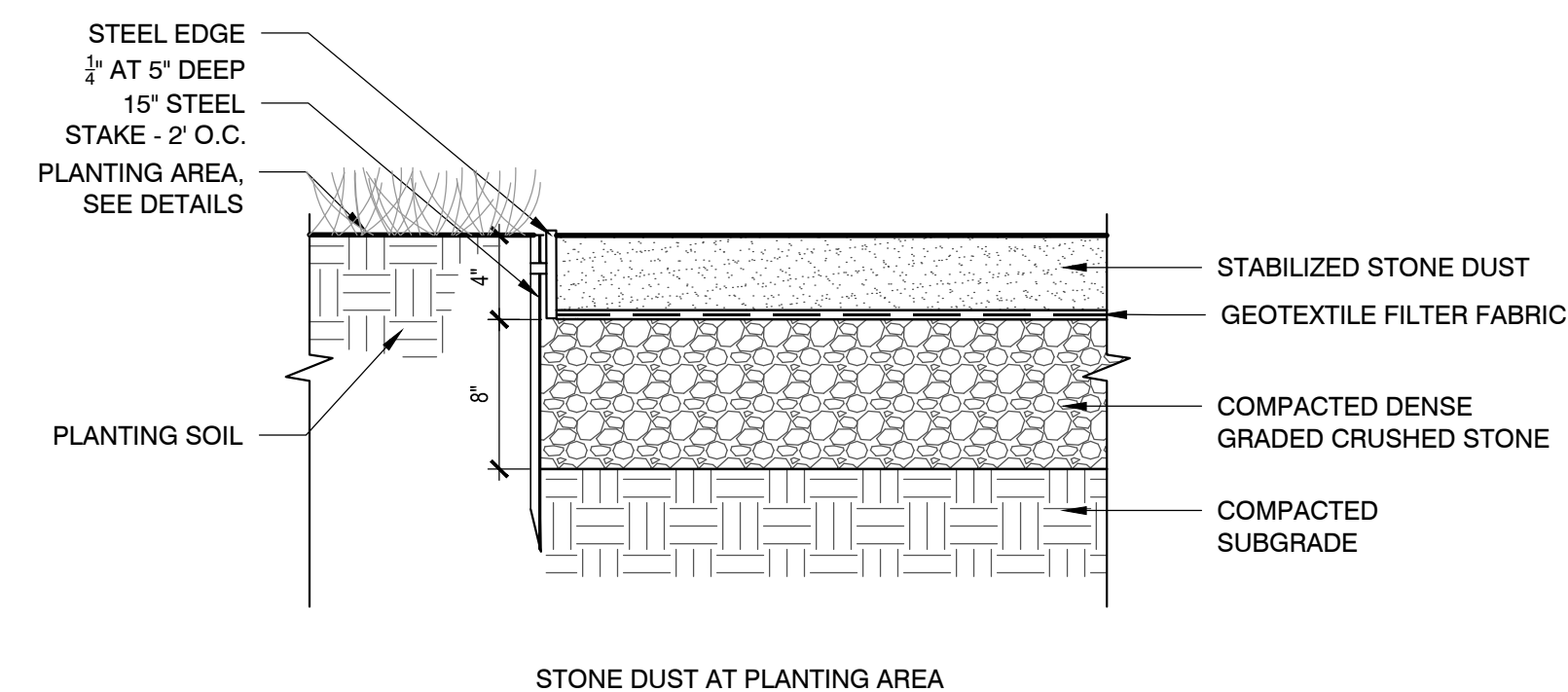

**7** STONE DUST PAVING WITH STEEL EDGE  
SCALE: N.T.S.

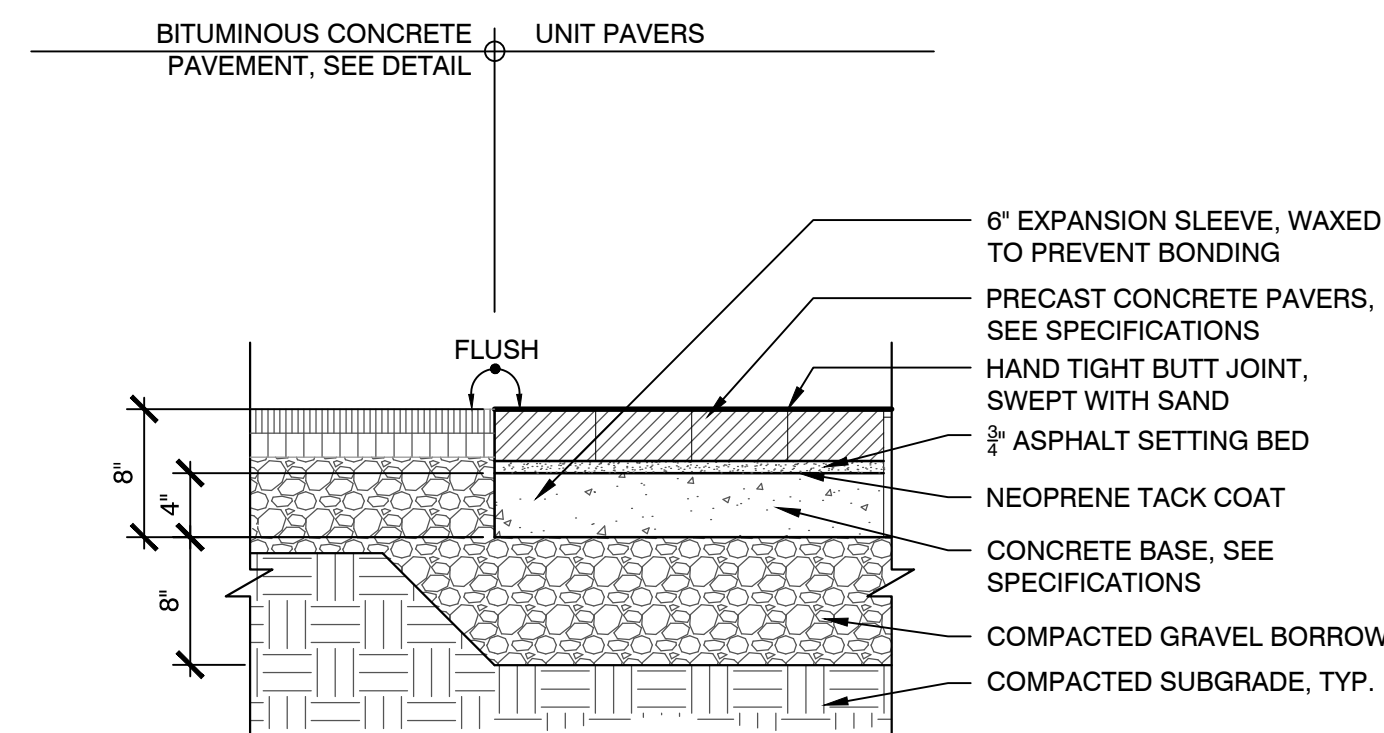

**8** UNIT PAVERS AT BITUMINOUS CONCRETE PAVEMENT  
SCALE: N.T.S.

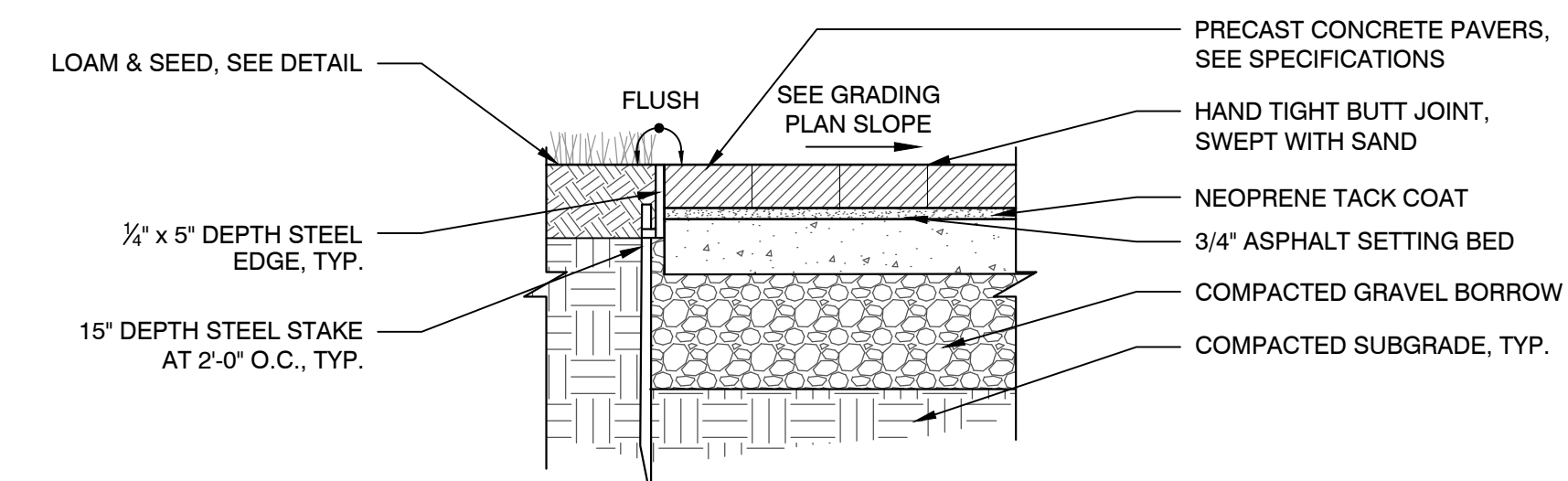

**9** UNIT PAVERS AT PLANTING AREA  
SCALE: N.T.S.

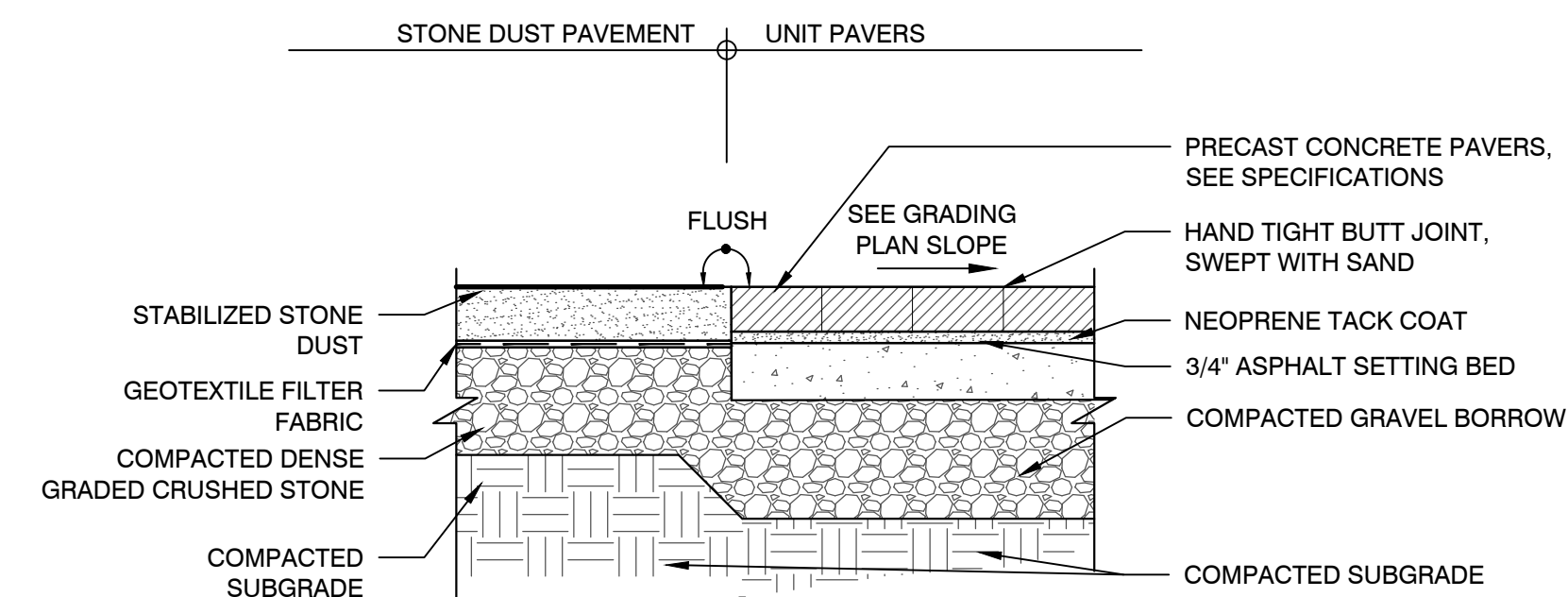

**10** UNIT PAVERS AT STONE DUST  
SCALE: N.T.S.

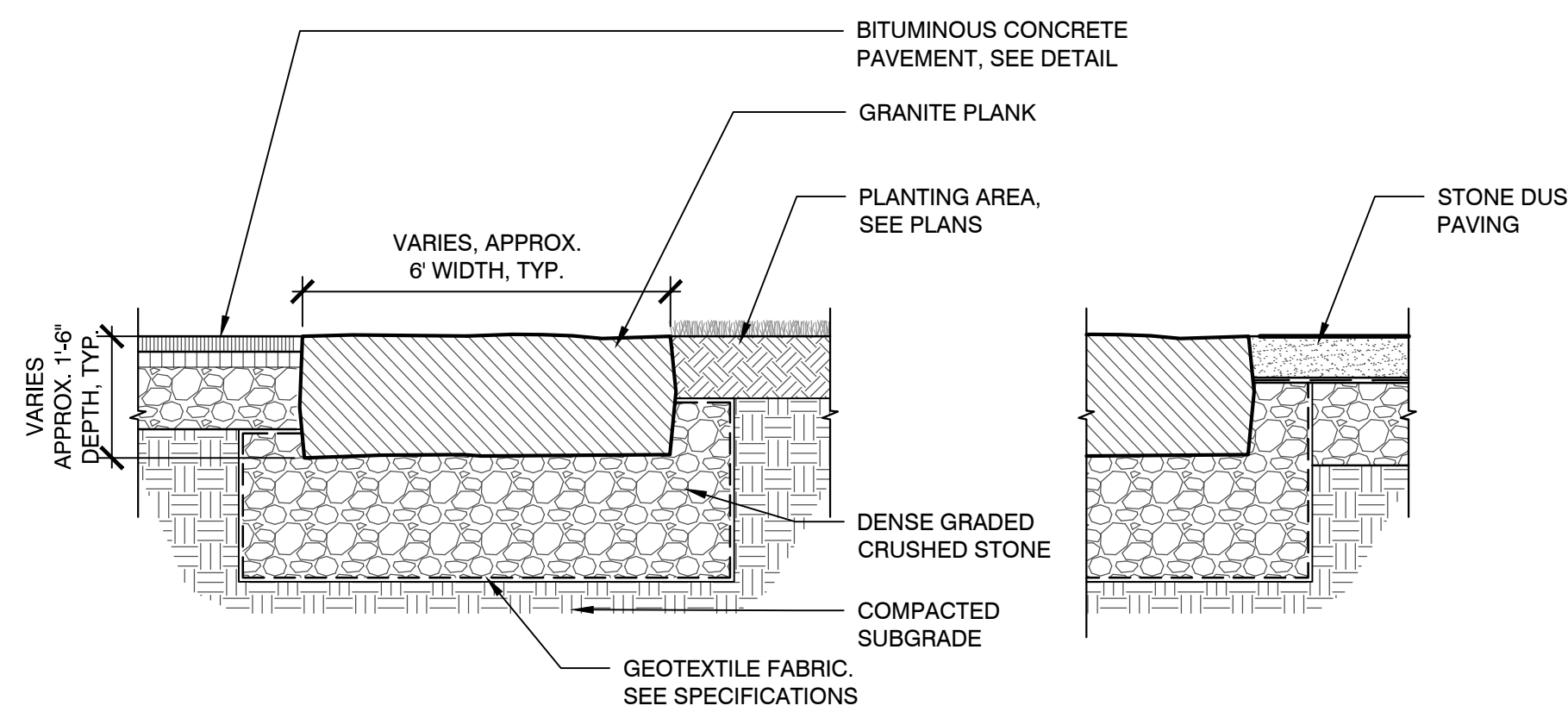

**11** ENGRAVED GRANITE PLANKS  
SCALE: N.T.S.

Project:  
PEABODY RIVERWALK  
RIVERWALK PARK

WALLIS STREET -  
CALLER STREET -  
HOWLEY STREET  
PEABODY, MA. 01960

Weston & Sampson  
WESTON & SAMPSON ENGINEERS, INC.  
85 DEVONSHIRE STREET, 3RD FLOOR  
BOSTON, MA 02109  
617-412-4480  
www.westonandsampson.com

Consultants:

Revisions:

No.	Date	Description

Seal:

Key Plan:

Issued For:

75% CONSTRUCTION DOCUMENTS  
- NOT FOR CONSTRUCTION -

Scale: N.T.S.  
Date: APRIL 2021  
Drawn By: FD, TY, SG  
Reviewed By: CC  
Approved By: CFR

W&S Project No.: ENG20-0145  
W&S File No.:

Drawing Title:

CONSTRUCTION DETAILS

Sheet Number:

L502

COPYRIGHT © 2020 WESTON & SAMPSON, INC.



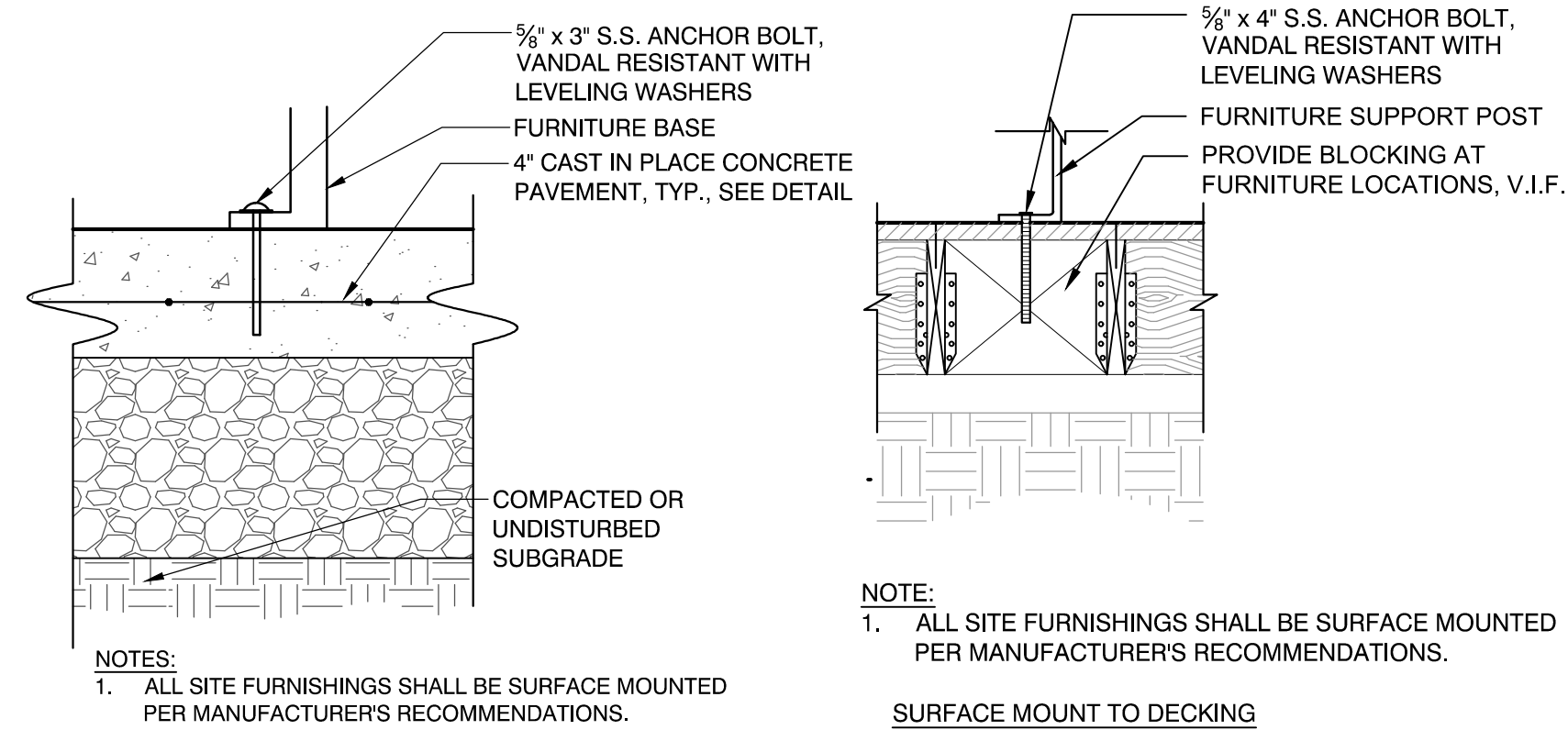

**1 FURNITURE SURFACE MOUNT**  
SCALE: N.T.S.

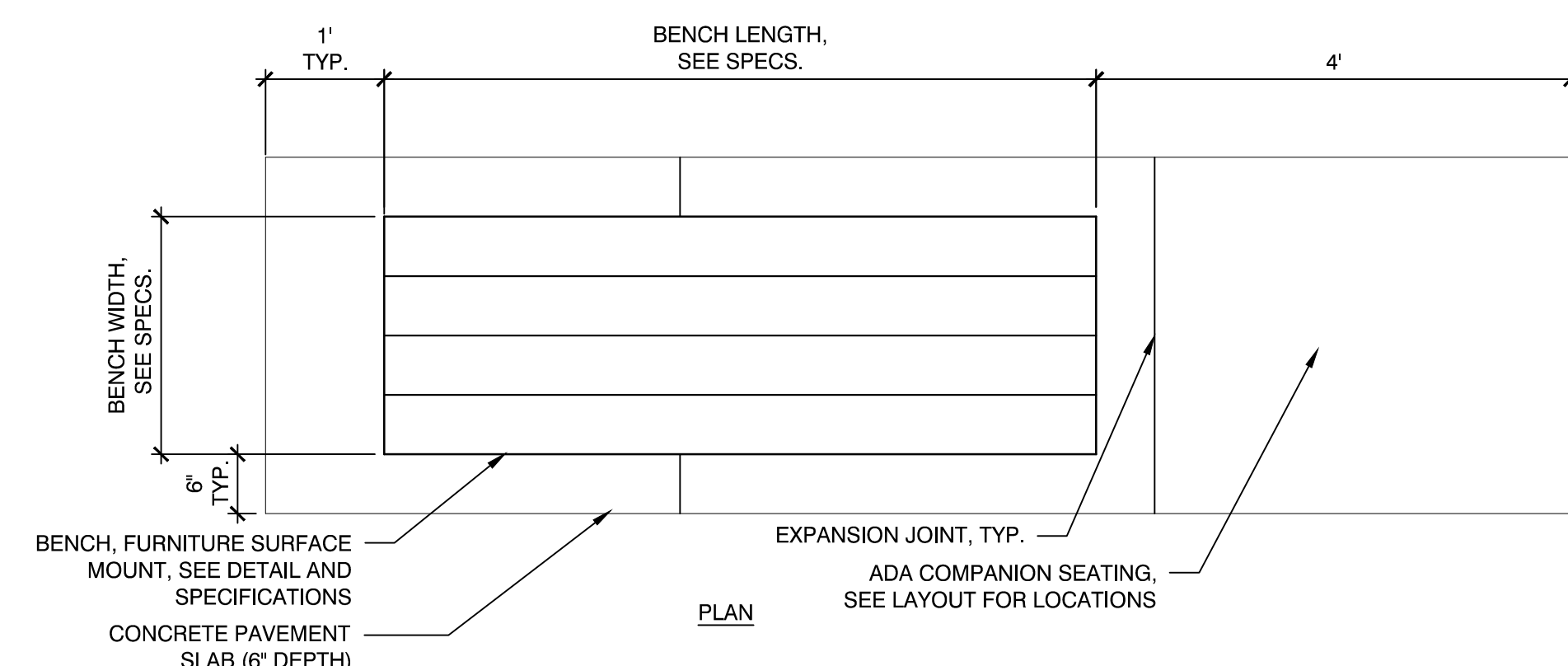

**2 BENCH ON CONCRETE PAD**  
SCALE: N.T.S.

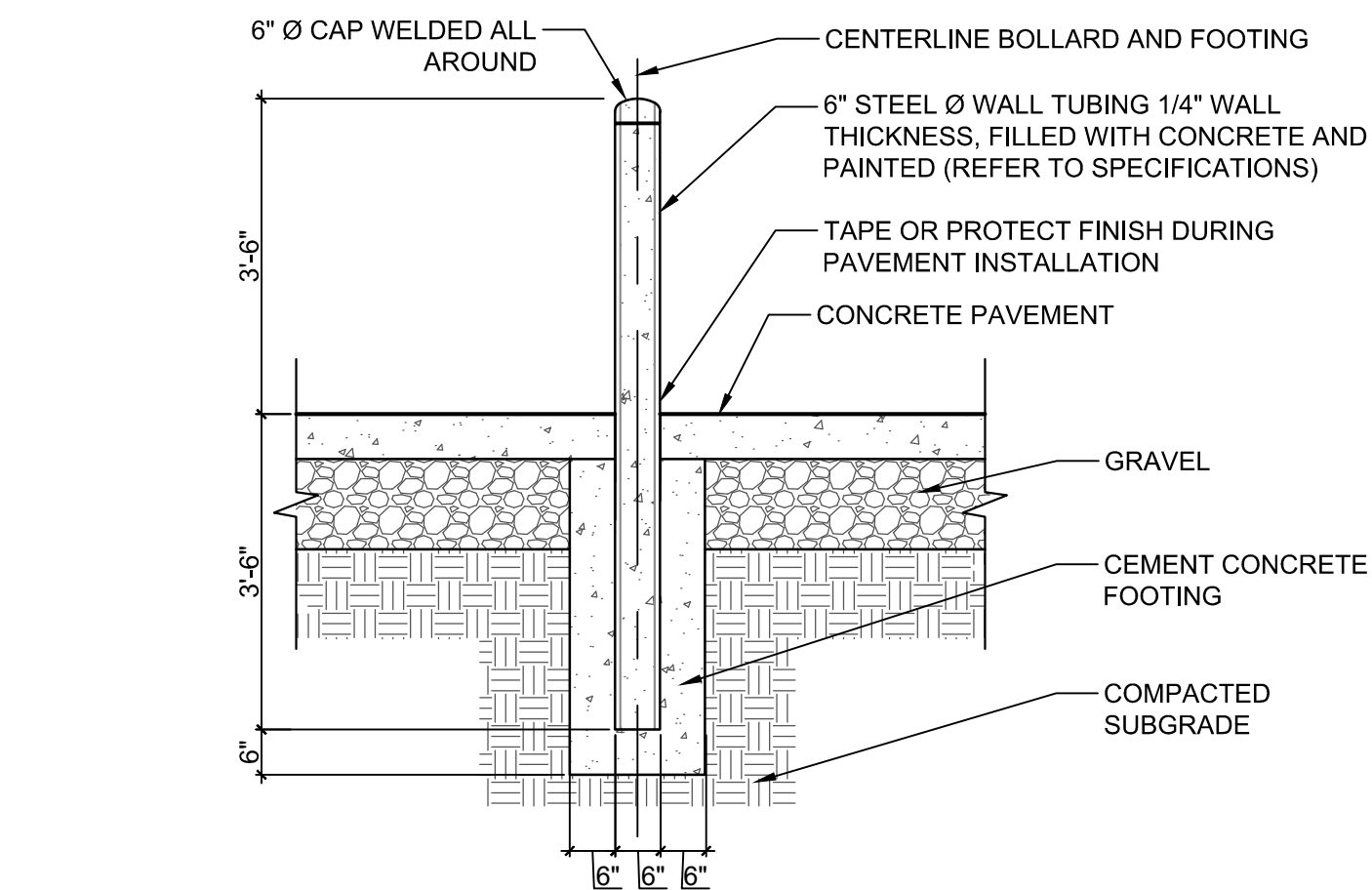

**3 VEHICLE BOLLARD**  
SCALE: N.T.S.

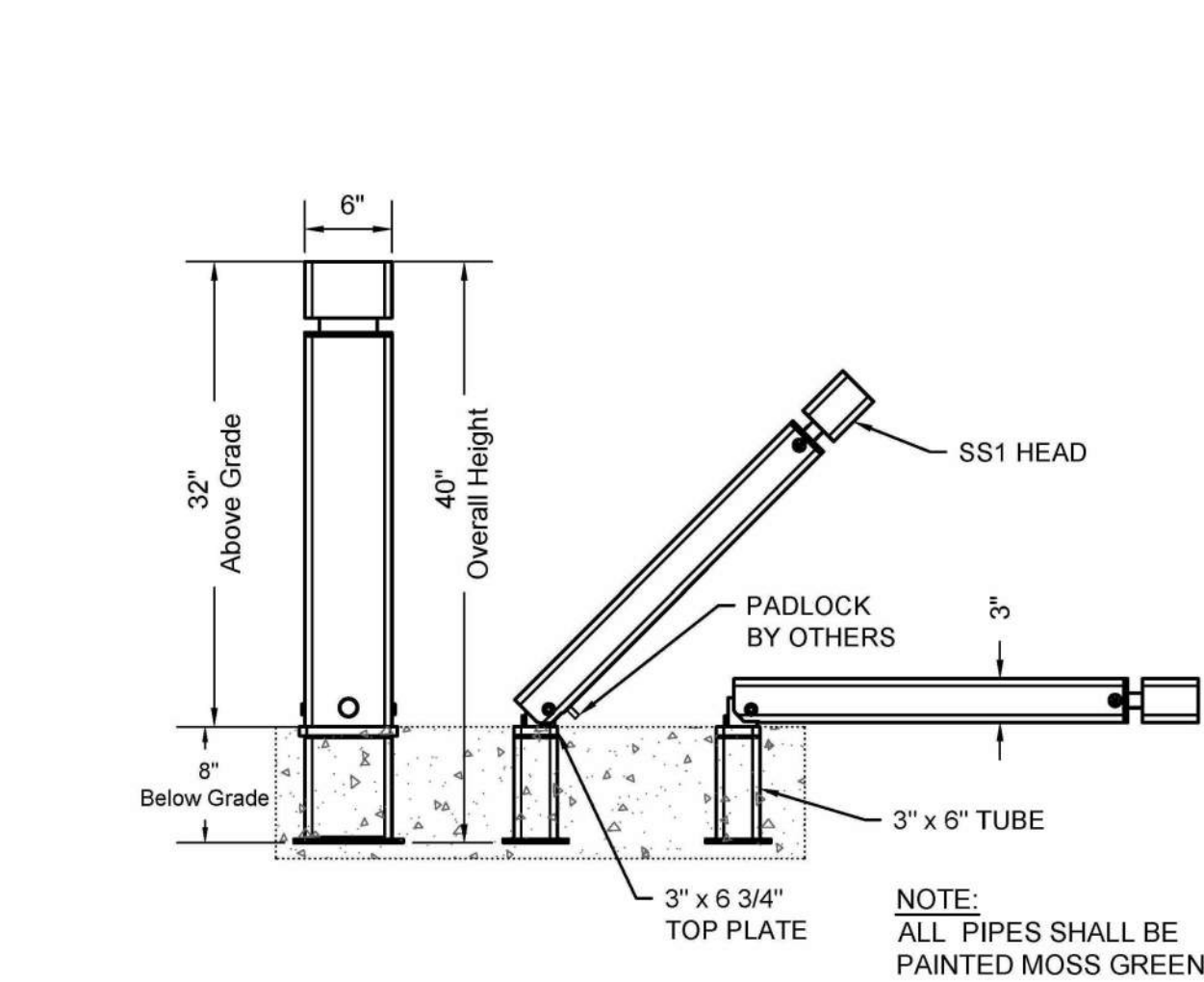

**4 COLLAPSIBLE BOLLARD**  
SCALE: N.T.S.

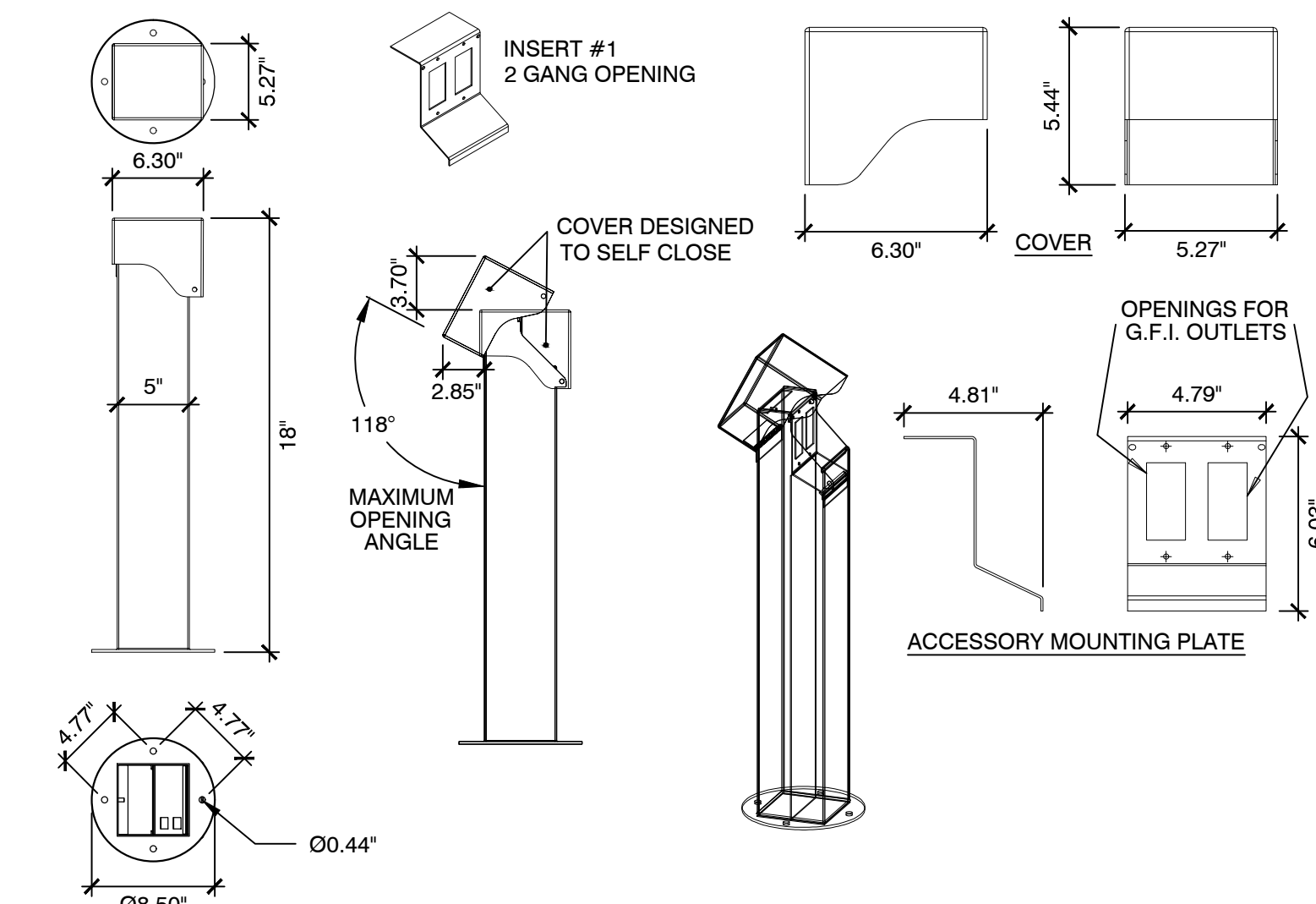

**5 UTILITY BOLLARD**  
SCALE: N.T.S.

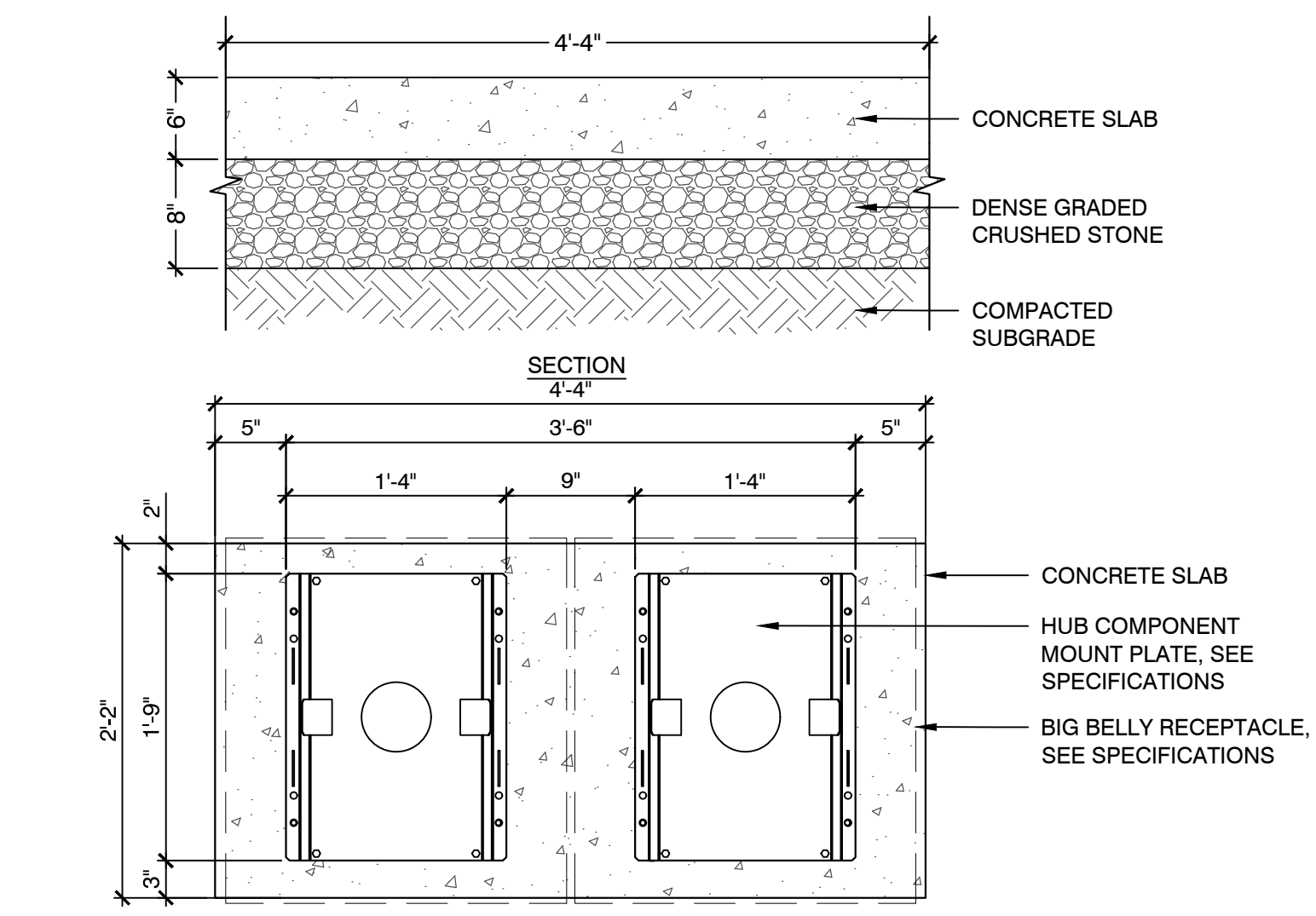

**6 TRASH AND RECYCLE RECEPTACLES ON CONCRETE SLAB**  
SCALE: N.T.S.

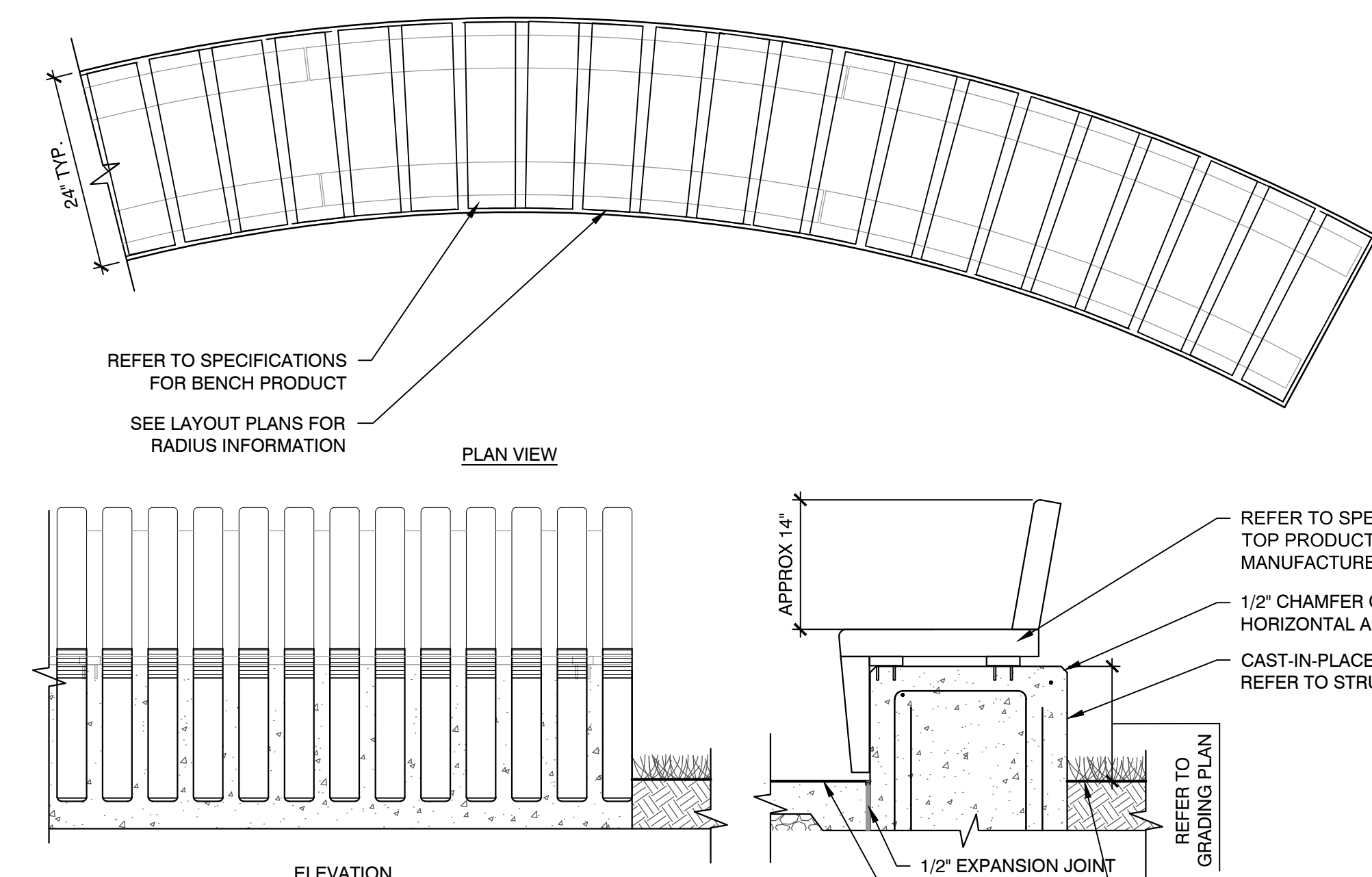

**7 CIP CONCRETE SEATWALL WITH WOOD SLAT TOP**  
SCALE: N.T.S.

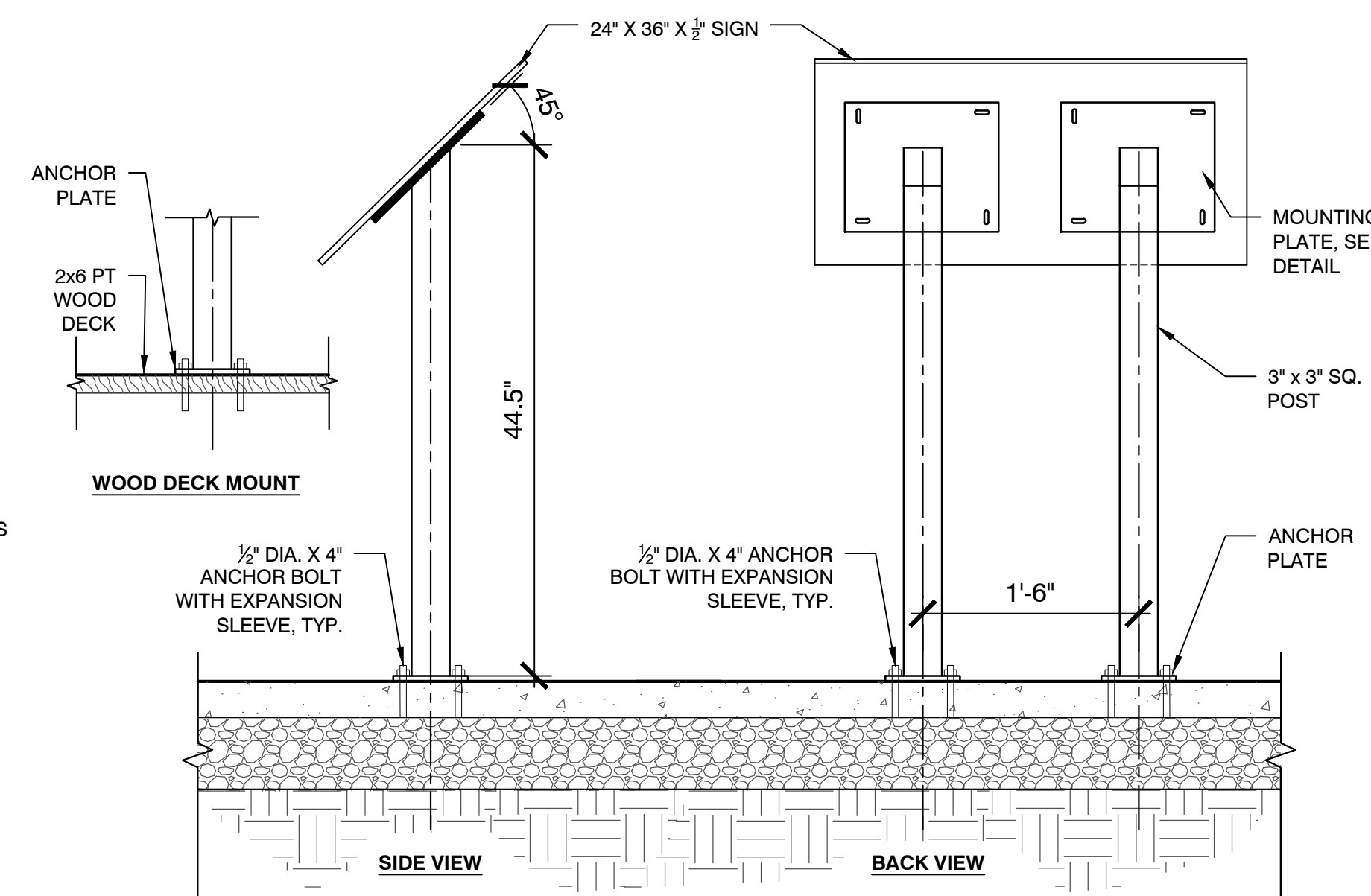

**8 INTERPRETIVE SIGNAGE - DOUBLE POST**  
SCALE: N.T.S.

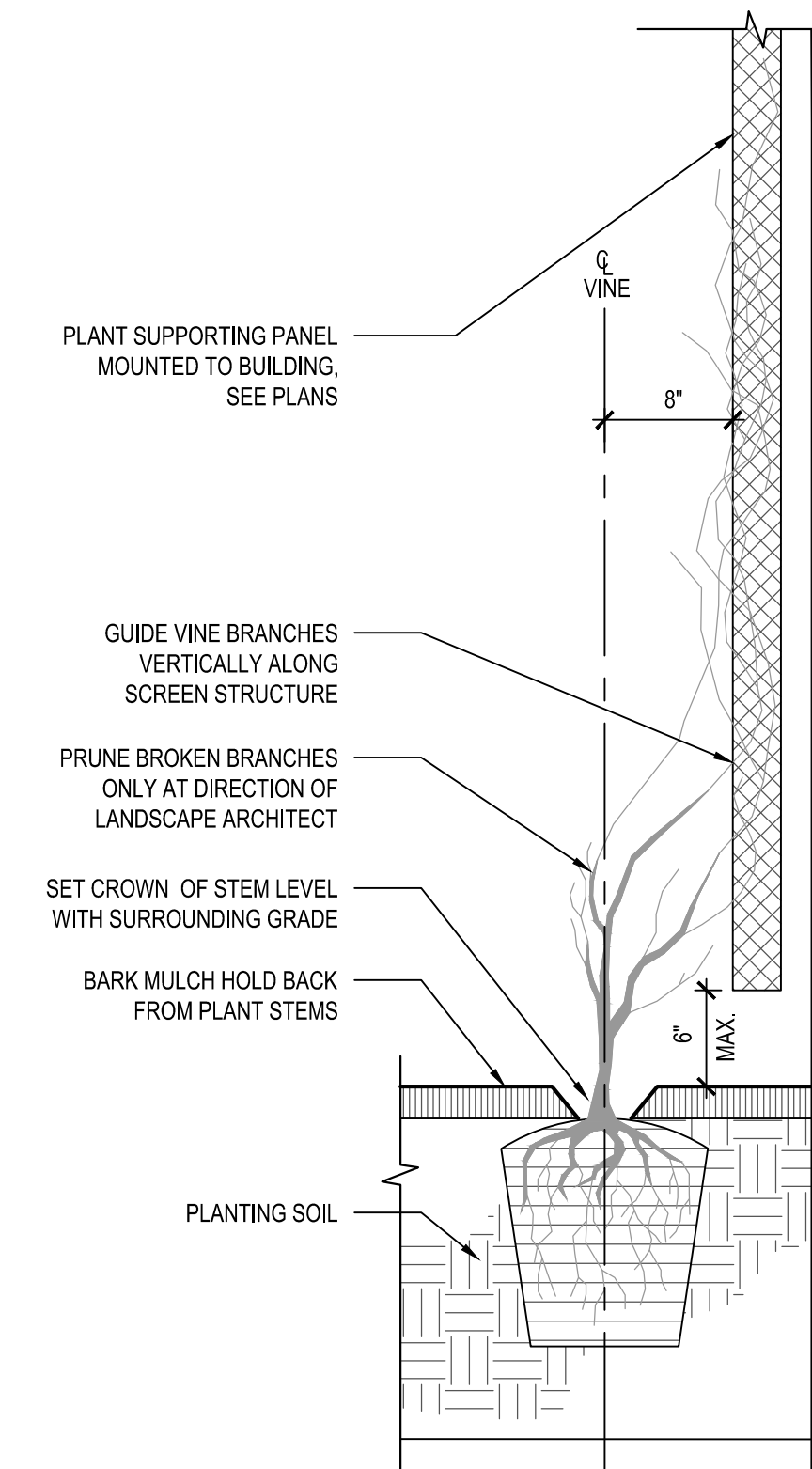

**9 GREEN SCREEN PLANTING AT FACE OF BUILDING**  
SCALE: N.T.S.

Consultants:

Revisions:

No.	Date	Description

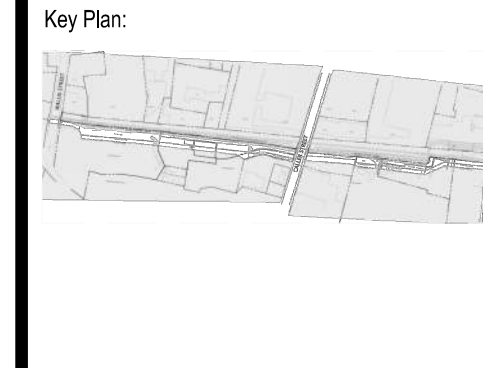

Issued For:  
**75% CONSTRUCTION DOCUMENTS - NOT FOR CONSTRUCTION -**

Scale: N.T.S.  
Date: APRIL 2021  
Drawn By: FD, TY, SG  
Reviewed By: CC  
Approved By: CFR  
W&S Project No.: ENG20-0145  
W&S File No.:

Drawing Title:  
**CONSTRUCTION DETAILS**

Sheet Number:  
**L503**



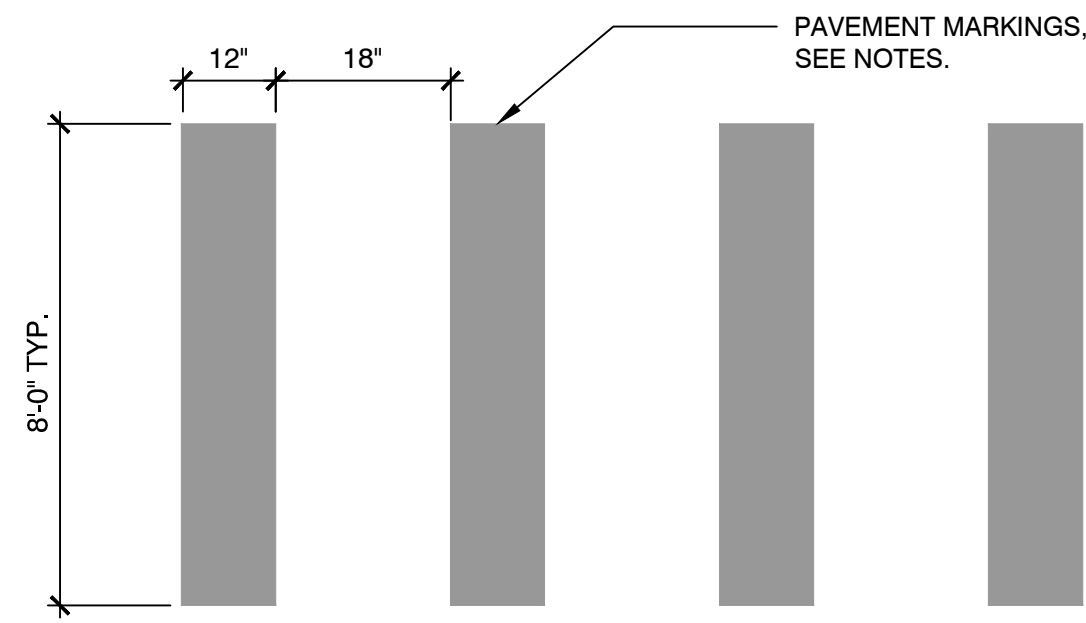

- NOTES:
1. PROVIDE PAVEMENT MARKINGS WHERE SHOWN ON PLANS IN ACCORDANCE WITH THIS DETAIL.
  2. PAVEMENT MARKINGS SHALL BE WHITE, REFLECTORIZED TRAFFIC PAINT CONFORMING TO FEDERAL SPECIFICATION TTP-1952B TRAFFIC PAINT, TYPE I OR II.

**1** CROSSWALK PAVEMENT MARKINGS  
SCALE: N.T.S.

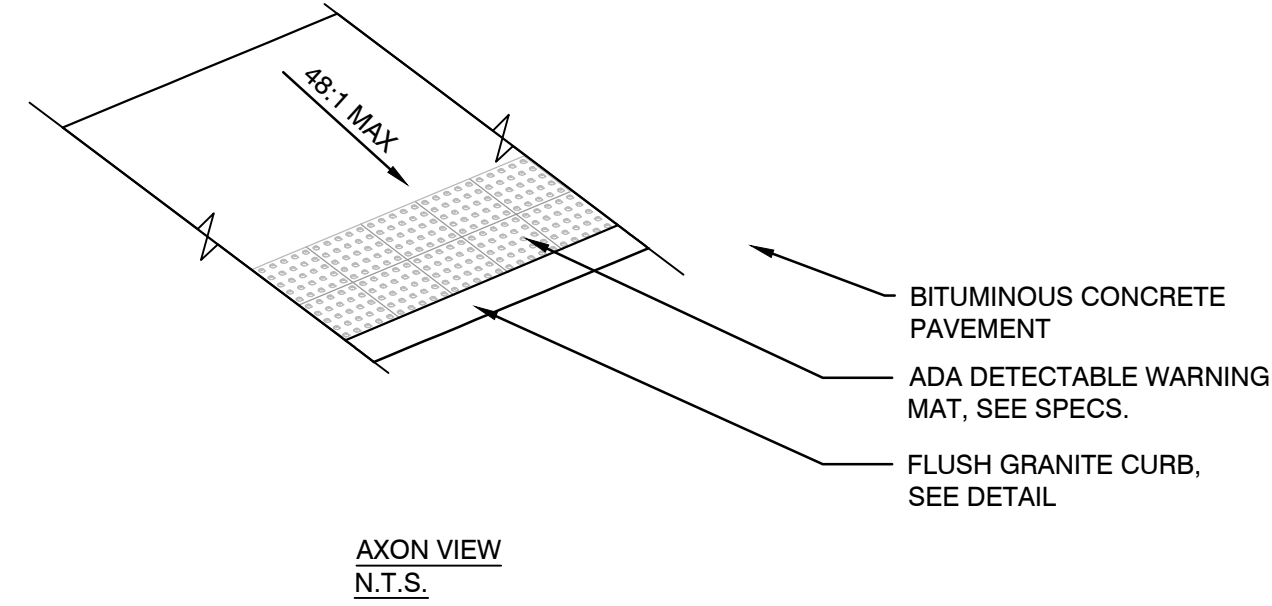

BITUMINOUS CONCRETE PAVEMENT  
ADA DETECTABLE WARNING MAT, SEE SPECS.  
FLUSH GRANITE CURB, SEE DETAIL

**2** ADA ACCESSIBLE CURB CUT AT WALLIS STREET - WEST  
SCALE: N.T.S.

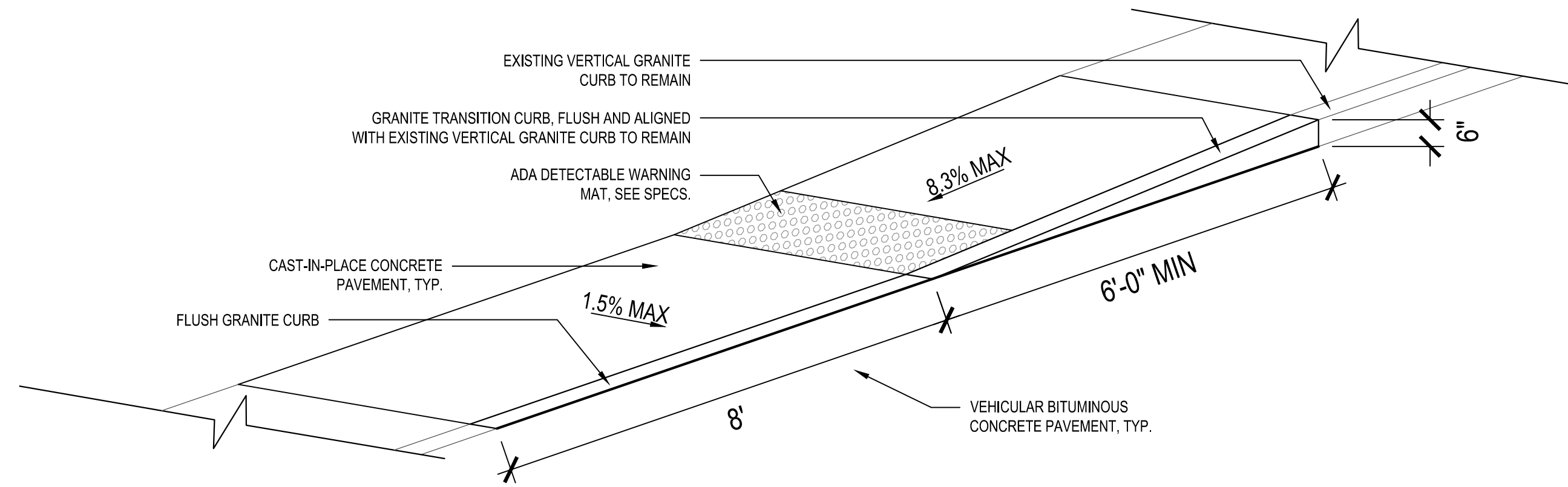

- NOTES:
1. CONTRACTOR SHALL PROVIDE CLEAN AND STRAIGHT SAWCUT LINES AT LIMIT OF REMOVAL OF EXISTING ASPHALT PAVEMENT TO REMAIN.
  2. CONTRACTOR SHALL VERIFY LIMITS OF EXISTING ASPHALT PAVEMENT REMOVAL PRIOR TO COMMENCING DEMOLITION.
  3. CONTRACTOR SHALL REMOVE AND REPLACE ASPHALT PAVEMENT, GRAVEL BORROW, AND SUBGRADE NECESSARY TO CONSTRUCT A CLEAN, SMOOTH TRANSITION AT ADA CURB CUT.

**3** ADA ACCESSIBLE CURB CUT AT WALLIS STREET - EAST  
SCALE: N.T.S.

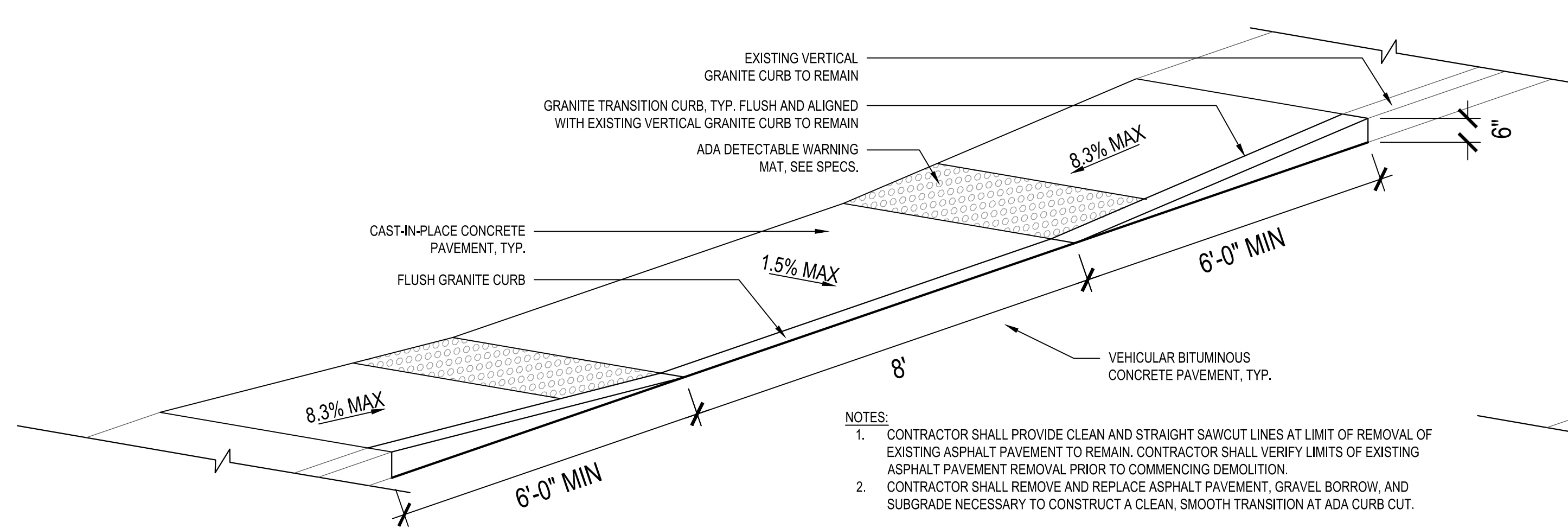

- NOTES:
1. CONTRACTOR SHALL PROVIDE CLEAN AND STRAIGHT SAWCUT LINES AT LIMIT OF REMOVAL OF EXISTING ASPHALT PAVEMENT TO REMAIN. CONTRACTOR SHALL VERIFY LIMITS OF EXISTING ASPHALT PAVEMENT REMOVAL PRIOR TO COMMENCING DEMOLITION.
  2. CONTRACTOR SHALL REMOVE AND REPLACE ASPHALT PAVEMENT, GRAVEL BORROW, AND SUBGRADE NECESSARY TO CONSTRUCT A CLEAN, SMOOTH TRANSITION AT ADA CURB CUT.

**4** ADA ACCESSIBLE CURB CUT AT CALLER STREET - WEST  
SCALE: N.T.S.

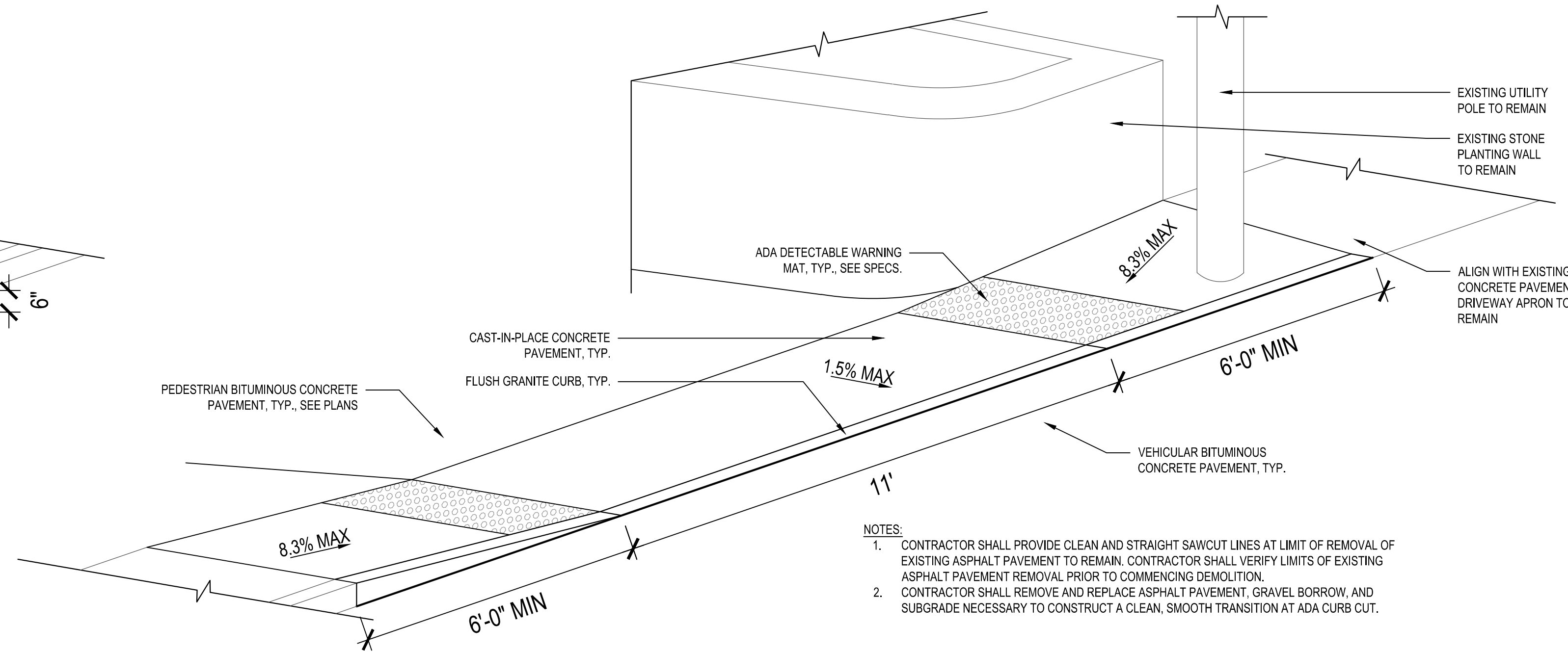

- NOTES:
1. CONTRACTOR SHALL PROVIDE CLEAN AND STRAIGHT SAWCUT LINES AT LIMIT OF REMOVAL OF EXISTING ASPHALT PAVEMENT TO REMAIN. CONTRACTOR SHALL VERIFY LIMITS OF EXISTING ASPHALT PAVEMENT REMOVAL PRIOR TO COMMENCING DEMOLITION.
  2. CONTRACTOR SHALL REMOVE AND REPLACE ASPHALT PAVEMENT, GRAVEL BORROW, AND SUBGRADE NECESSARY TO CONSTRUCT A CLEAN, SMOOTH TRANSITION AT ADA CURB CUT.

**5** ADA ACCESSIBLE CURB CUT AT CALLER STREET - EAST  
SCALE: N.T.S.

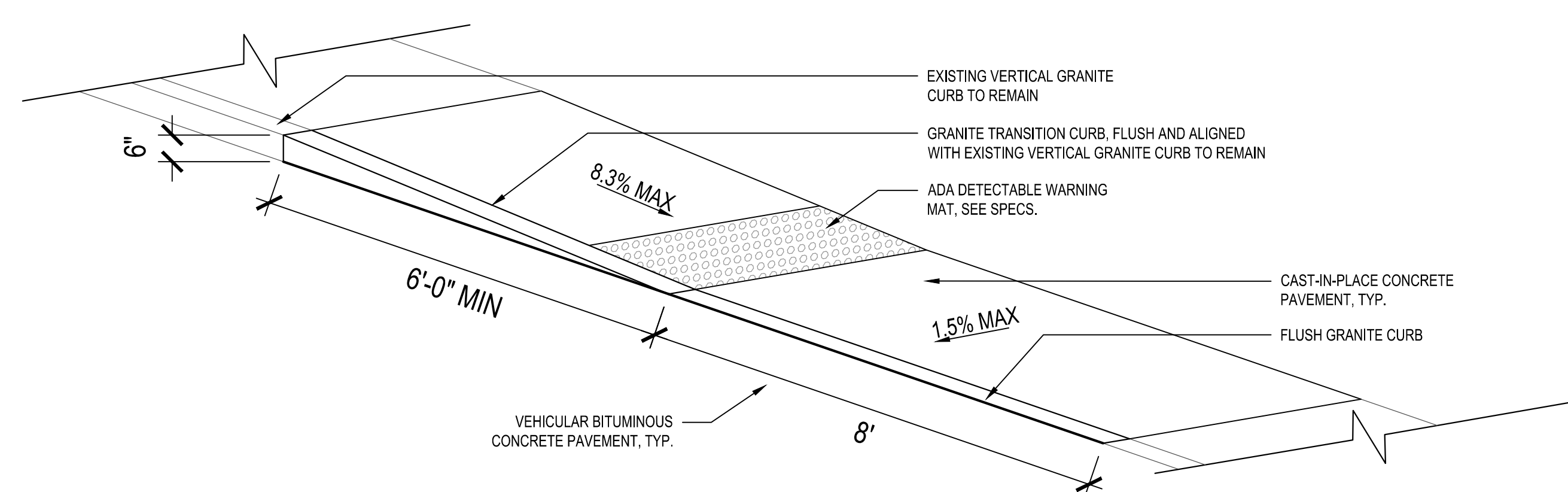

- NOTES:
1. CONTRACTOR SHALL PROVIDE CLEAN AND STRAIGHT SAWCUT LINES AT LIMIT OF REMOVAL OF EXISTING ASPHALT PAVEMENT TO REMAIN. CONTRACTOR SHALL VERIFY LIMITS OF EXISTING ASPHALT PAVEMENT REMOVAL PRIOR TO COMMENCING DEMOLITION.
  2. CONTRACTOR SHALL REMOVE AND REPLACE ASPHALT PAVEMENT, GRAVEL BORROW, AND SUBGRADE NECESSARY TO CONSTRUCT A CLEAN, SMOOTH TRANSITION AT ADA CURB CUT.

**6** ADA ACCESSIBLE CURB CUT AT HOWLEY STREET - WEST  
SCALE: N.T.S.

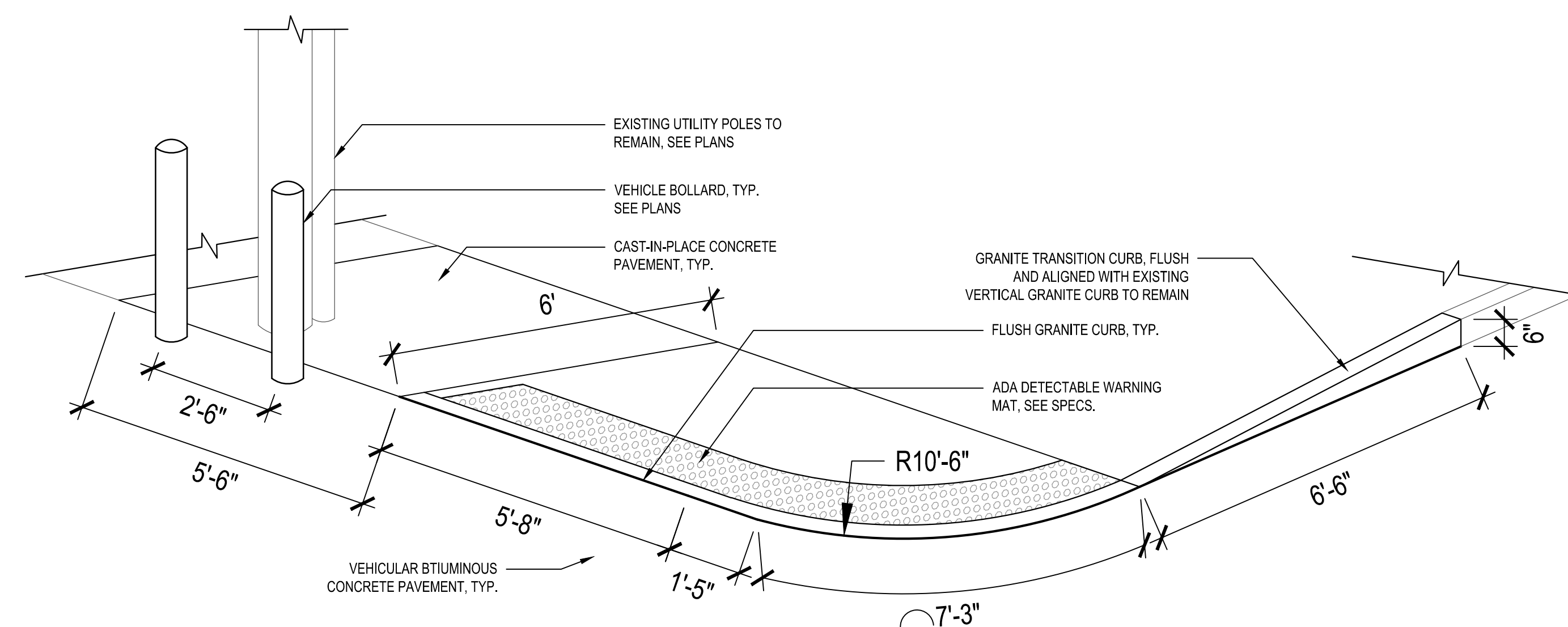

- NOTES:
1. ALL CROSS SLOPES SHALL NOT EXCEED 1.50%.
  2. CONTRACTOR SHALL PROVIDE CLEAN AND STRAIGHT SAWCUT LINES AT LIMIT OF REMOVAL OF EXISTING BITUMINOUS CONCRETE PAVEMENT TO REMAIN AT ROADWAY. CONTRACTOR SHALL VERIFY LIMITS OF EXISTING ASPHALT PAVEMENT REMOVAL PRIOR TO COMMENCING DEMOLITION.
  3. CONTRACTOR SHALL REMOVE AND REPLACE BITUMINOUS CONCRETE PAVEMENT, GRAVEL BORROW, AND SUBGRADE NECESSARY TO CONSTRUCT A CLEAN, SMOOTH TRANSITION AT ADA CURB CUT.

**7** ADA ACCESSIBLE CURB CUT AT HOWLEY STREET - EAST  
SCALE: N.T.S.

Consultants:

Revisions:

No.	Date	Description

Seal:



Issued For:  
75% CONSTRUCTION DOCUMENTS  
- NOT FOR CONSTRUCTION -

Scale: N.T.S.  
Date: APRIL 2021  
Drawn By: FD, TY, SG  
Reviewed By: CC  
Approved By: CFR  
W&S Project No.: ENG20-0145  
W&S File No.:

Drawing Title:  
CONSTRUCTION DETAILS

Sheet Number:  
L504



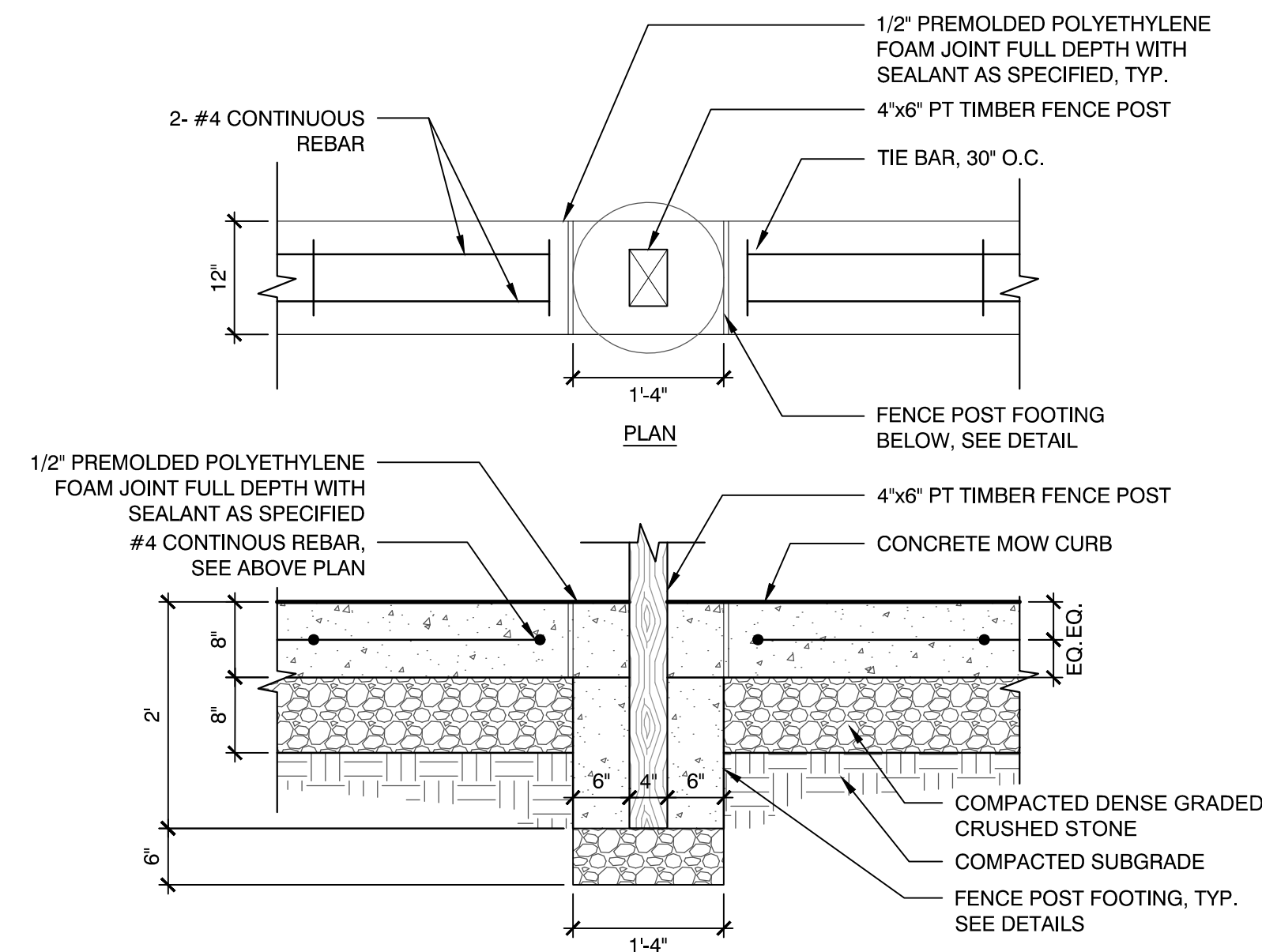

- NOTES:**
- MOW CURB CORNERS ADJACENT TO WALLS AND CURBS SHALL BE SQUARE TO ENSURE SMOOTH INTERFACE BETWEEN MATERIALS.
  - MOW CURB CORNERS ADJACENT TO PLANTING BED OR LAWN AREAS SHALL HAVE 1/2" CHAMFER.
  - CONTRACTOR SHALL PROVIDE 3/4" PRE-MOLDED POLYETHYLENE FOAM EXPANSION JOINT, FULL DEPTH WITH SEALANT AS SPECIFIED AT FENCE POSTS UNLESS OTHERWISE NOTED.
  - SEE CRITICAL ROOT ZONE NOTE ON SITE DEMOLITION AND PREPARATION PLAN.

**1 MOW CURB AT FENCE**  
SCALE: N.T.S.

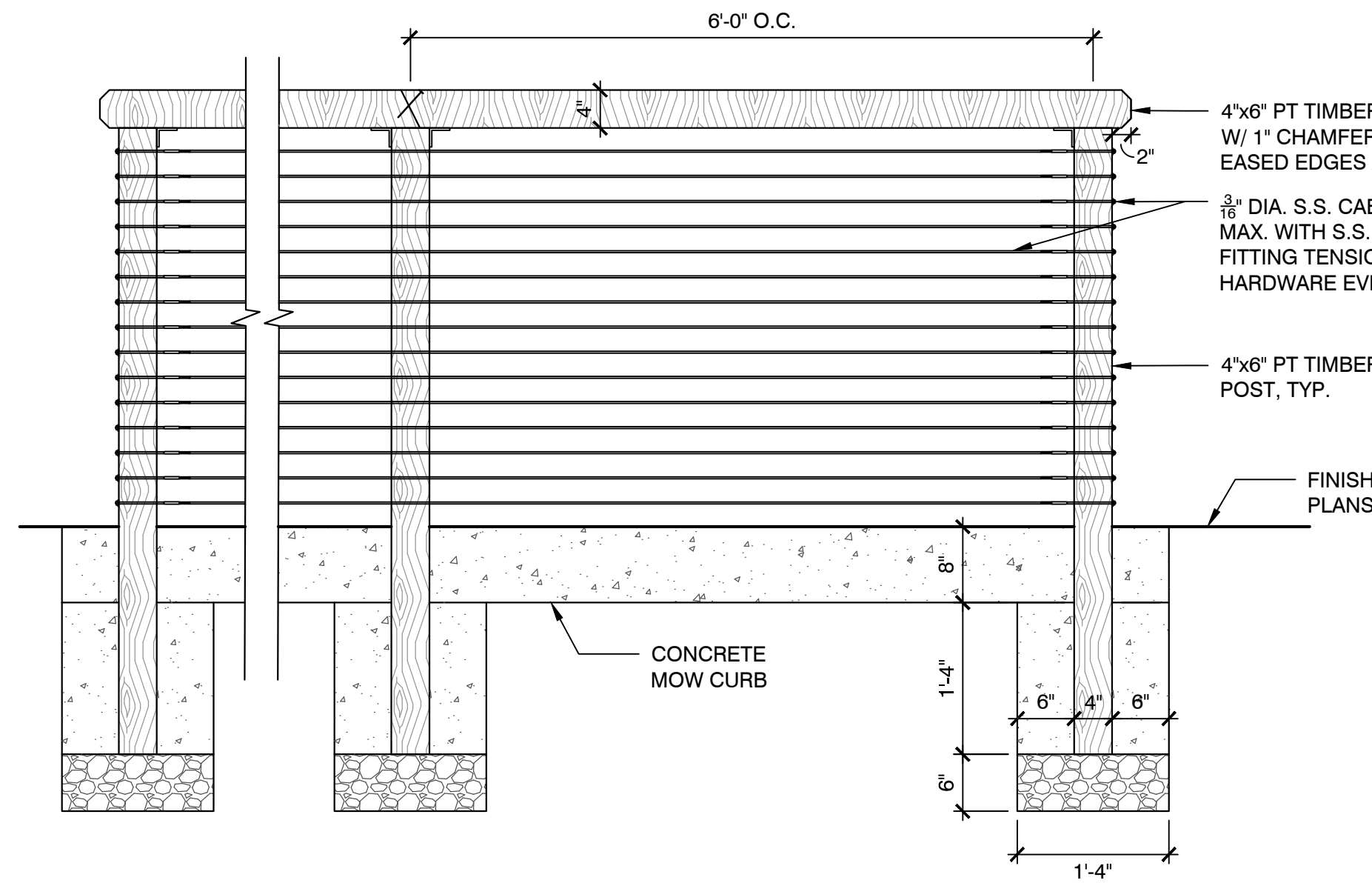

CABLE RAILING ELEVATION

**2 FENCE WITH CABLE RAILING**  
SCALE: N.T.S.

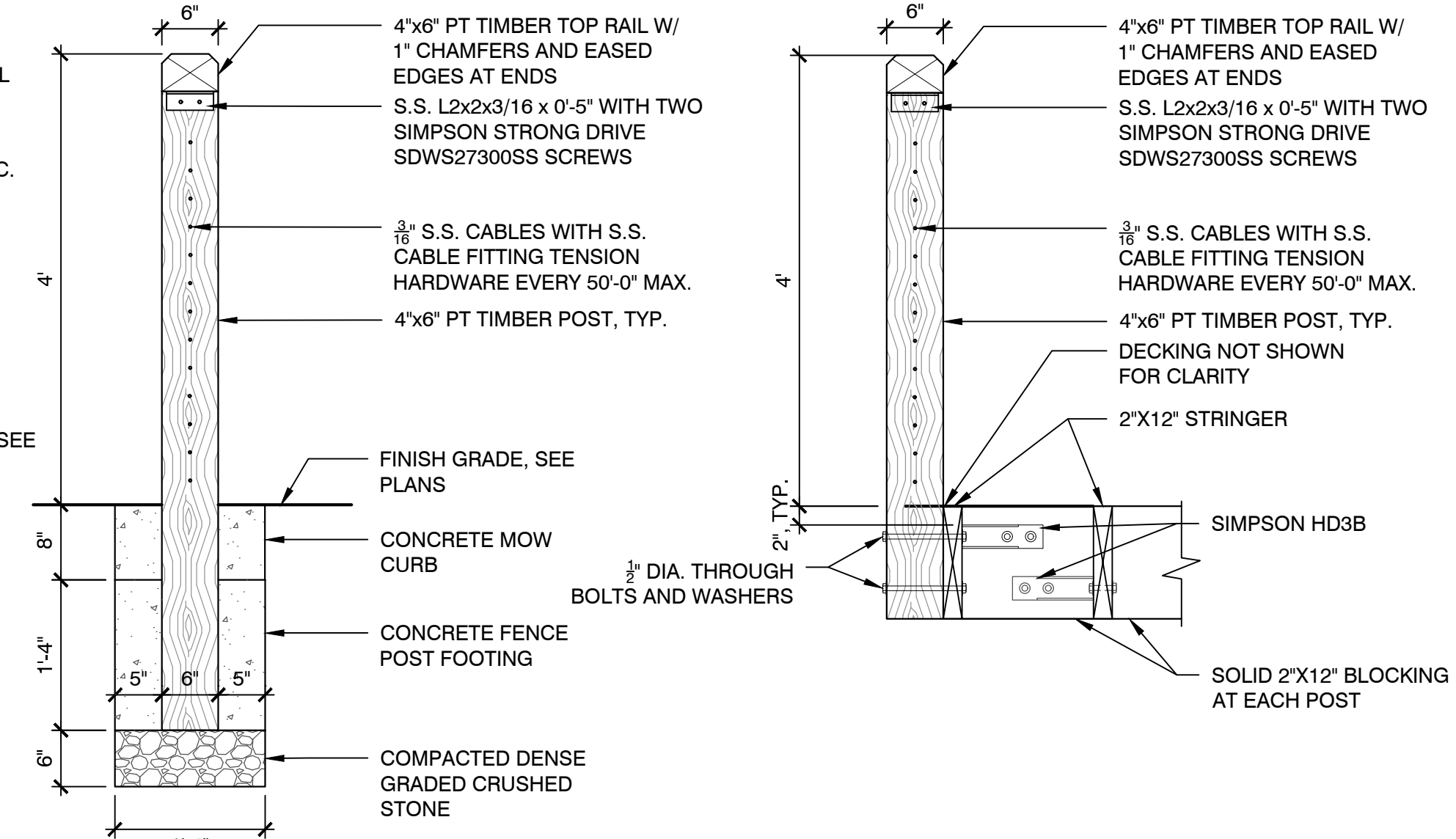

AT PATHWAY

AT BOARDWALK

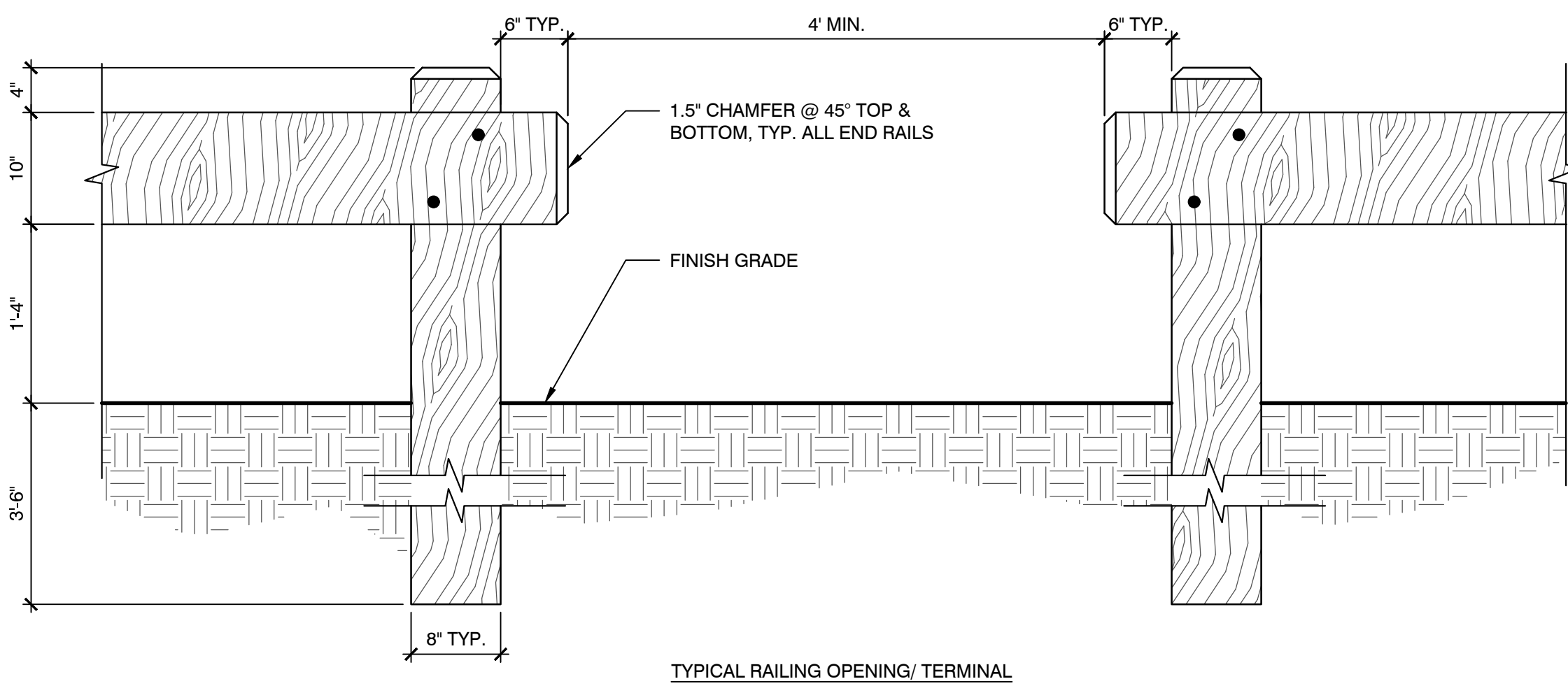

TYPICAL RAILING OPENING/ TERMINAL

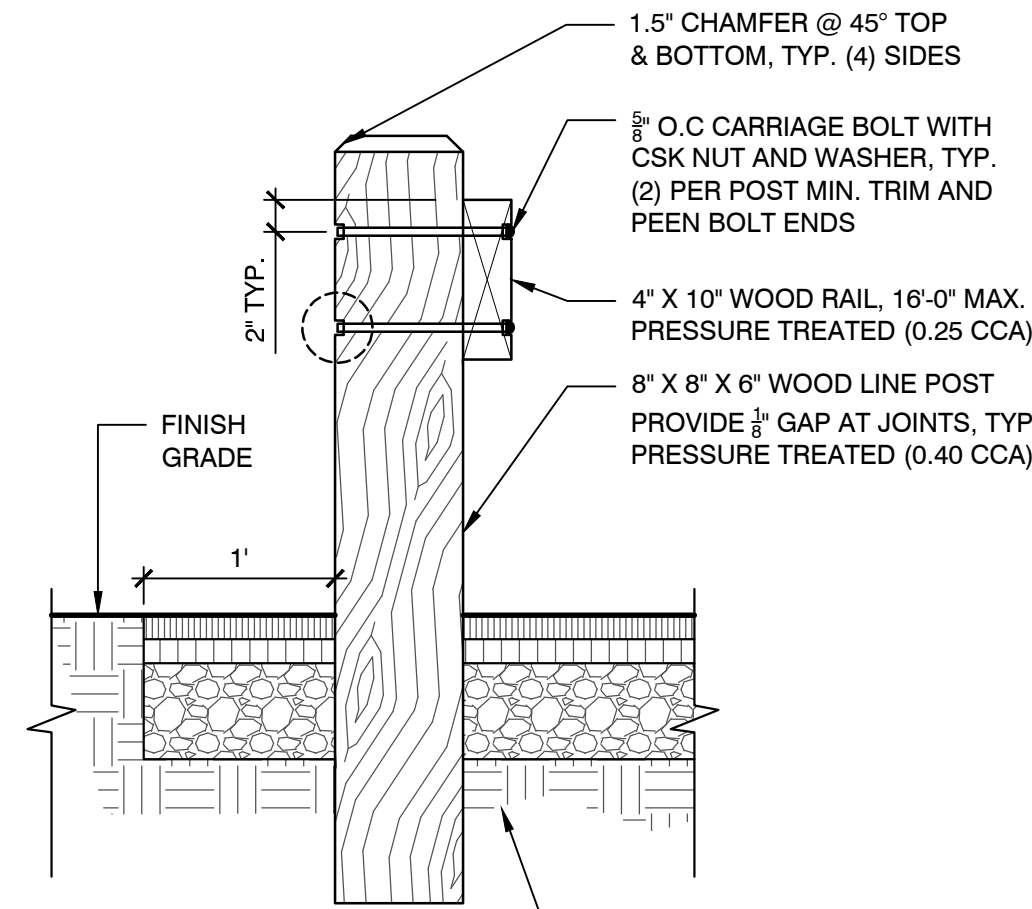

TYPICAL RAILING SECTION

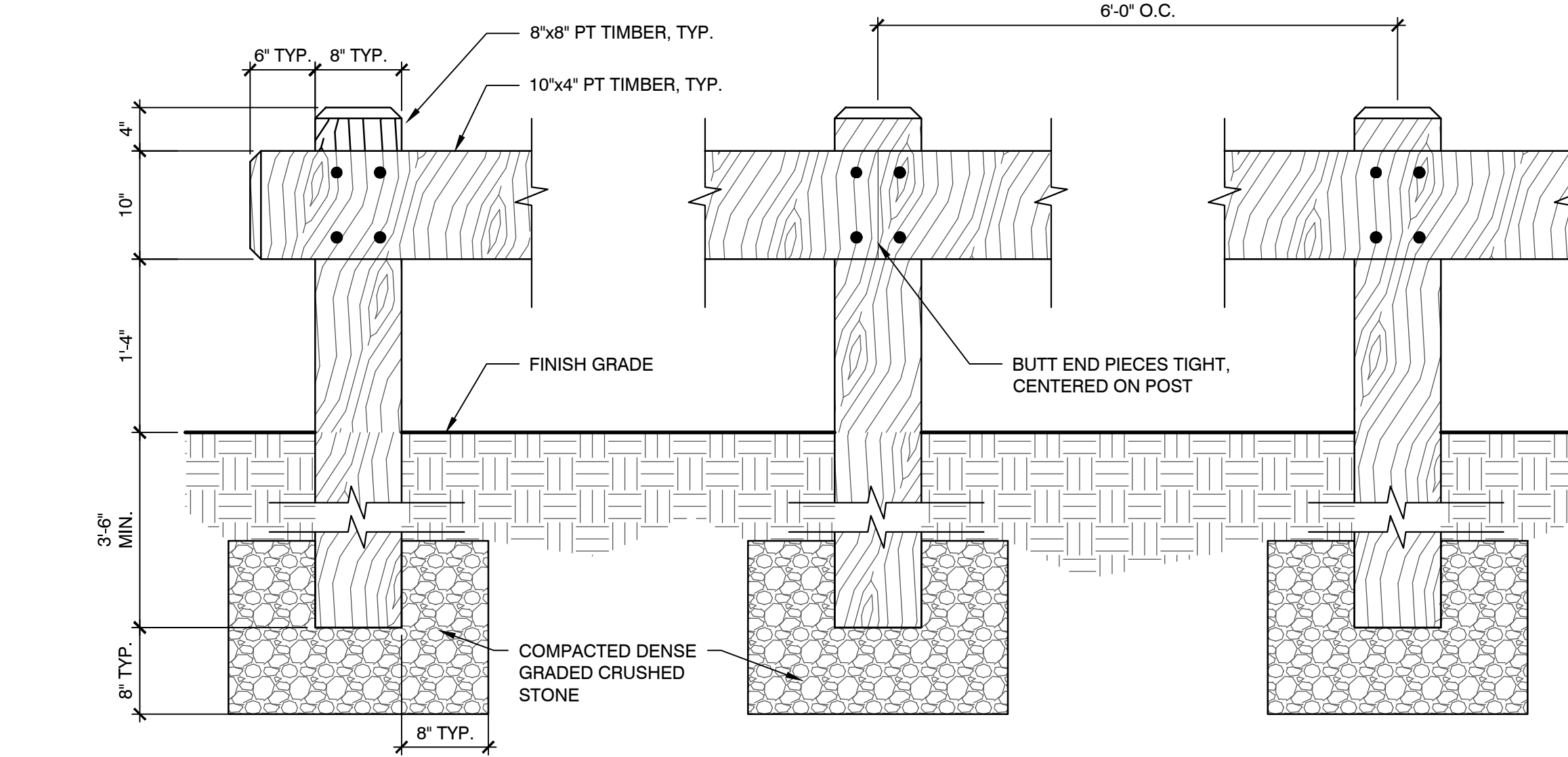

**3 WOOD GUARDRAIL**  
SCALE: N.T.S.

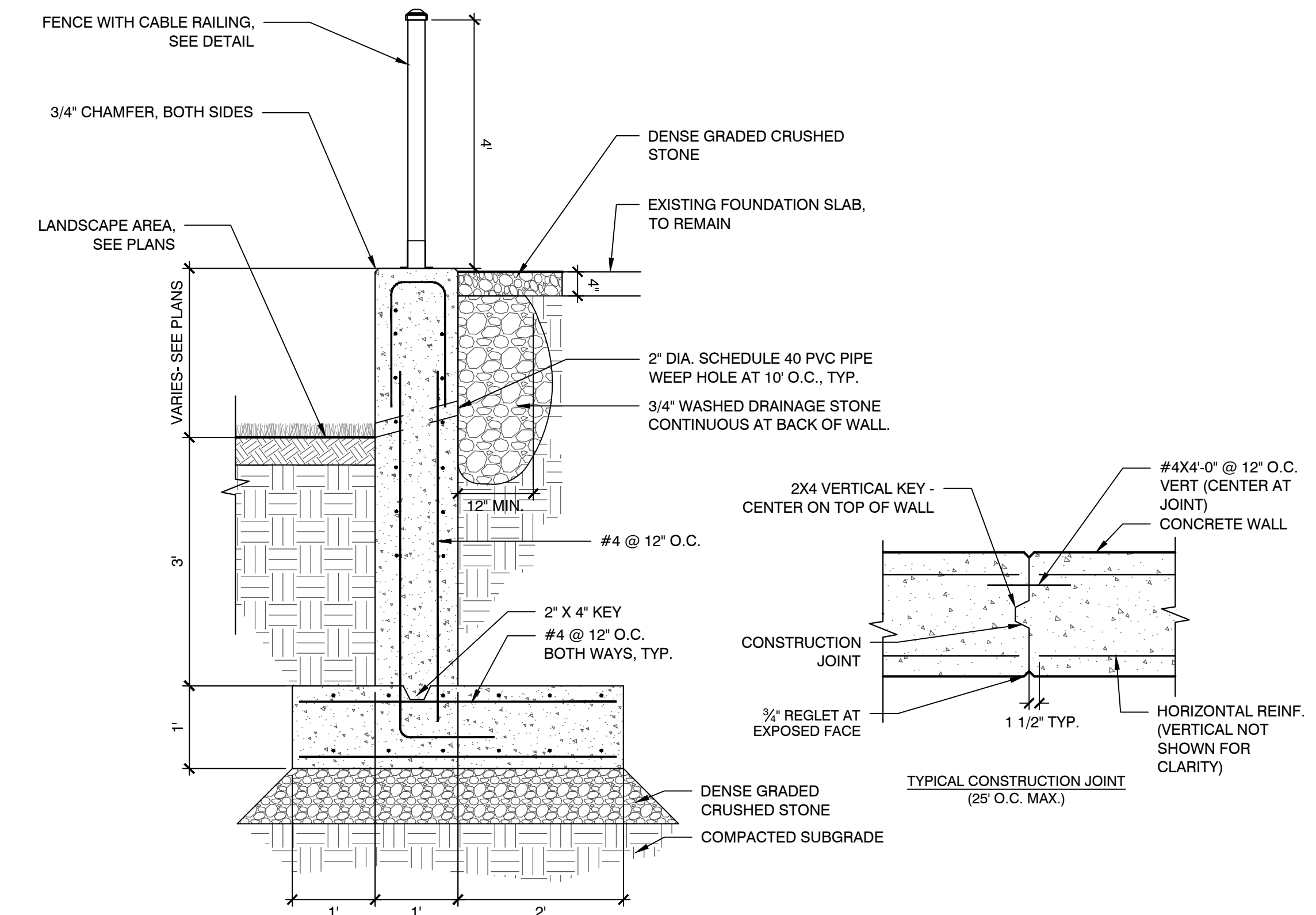
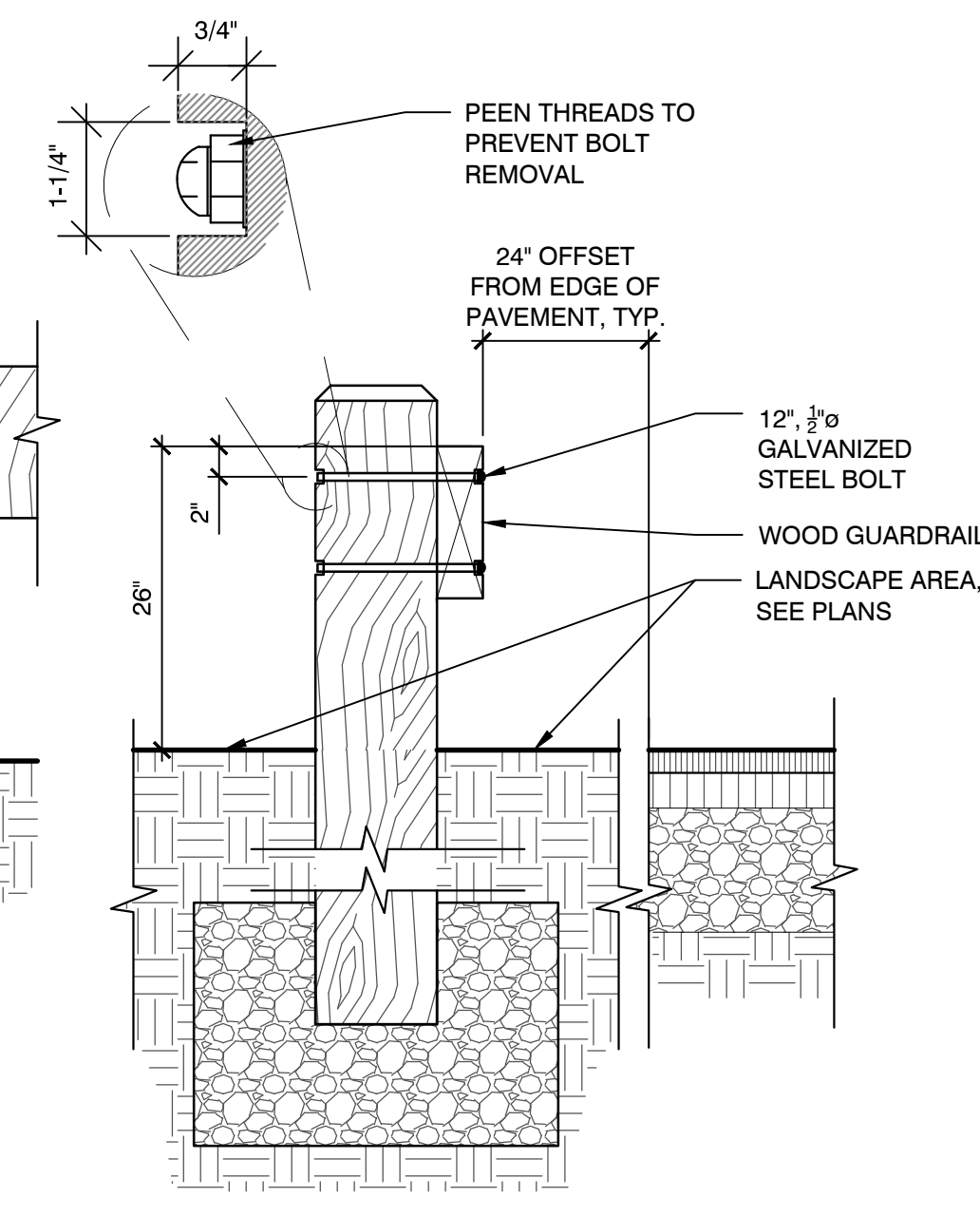

**4 CIP CONCRETE RETAINING WALL WITH DENSE GRADED CRUSHED STONE BACKFILL**  
SCALE: N.T.S.

Consultants:

Revisions:

No.	Date	Description

Key Plan:

Issued For:  
**75% CONSTRUCTION DOCUMENTS**  
- NOT FOR CONSTRUCTION -

Scale: N.T.S.  
Date: APRIL 2021  
Drawn By: FD, TY, SG  
Reviewed By: CC  
Approved By: CFR  
W&S Project No.: ENG20-0145  
W&S File No.:

Drawing Title:  
**CONSTRUCTION DETAILS**

Sheet Number:  
**L505**



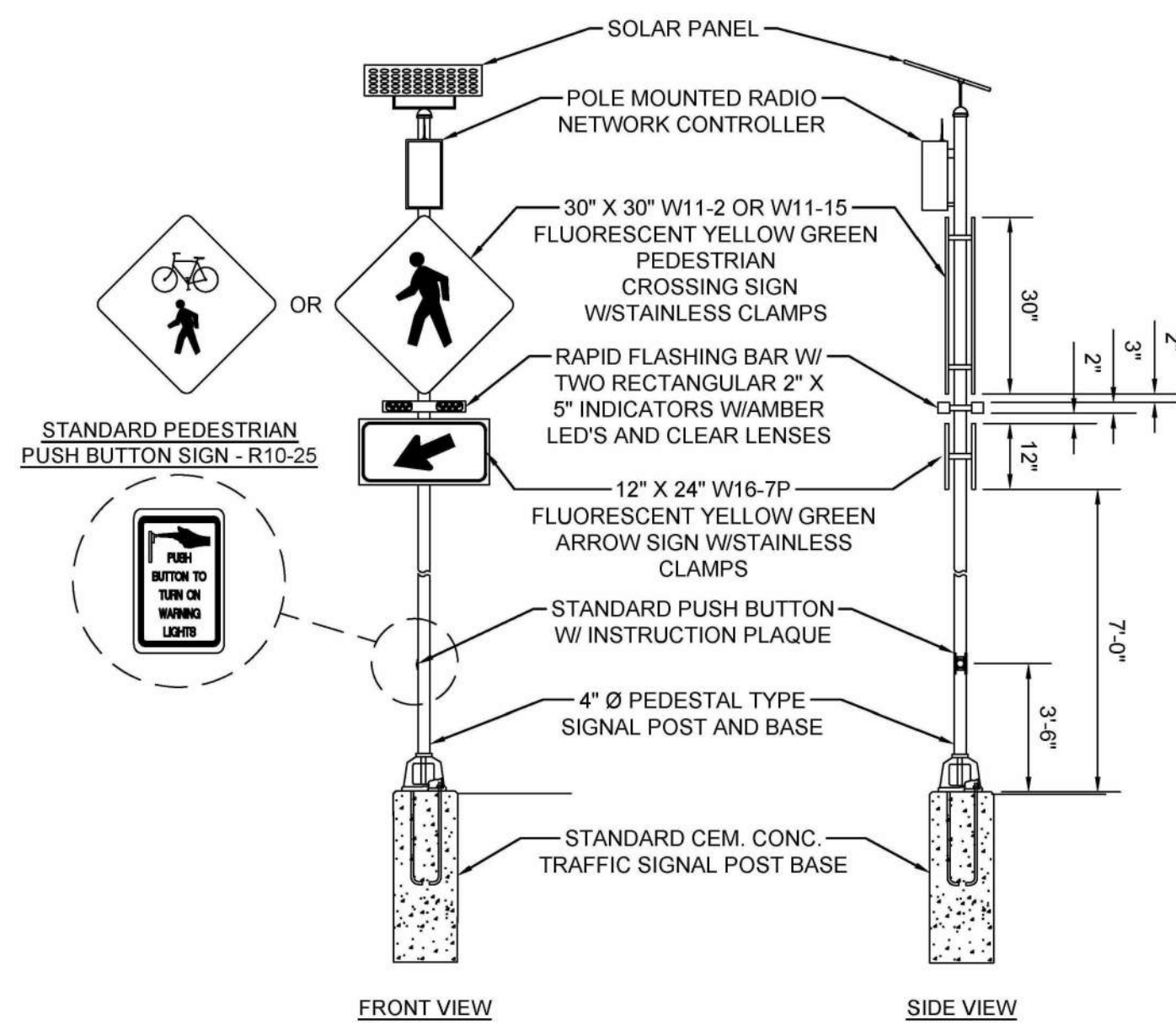

**1 RAPID FLASHING BEACON**  
SCALE: N.T.S.

- RRFB NOTES:**
- RECTANGULAR RAPID FLASHING BEACON (RRFB) SHALL BE SUPPLIED FROM A MANUFACTURER LISTED ON THE MASSDOT APPROVED EQUIPMENT LIST.
  - EACH LOCATION SHALL HAVE TWO (2) RRFB INSTALLED (ONE ON EACH SIDE OF THE CROSSWALK).
  - LOCATIONS 1 AND 3 WILL USE SIGN W11-15 AND LOCATION 2 WILL USE SIGN W11-2.
  - R10-25 SIGNS SHALL BE INSTALLED ABOVE ALL PEDESTRIAN PUSH BUTTONS.
  - OPERABLE CONTROLS ON RRFB SHALL BE LOCATED PER ADA STANDARDS 305-309
  - WARNING SIGNS AND INSTRUCTIONAL SIGNS ARE PAID SEPARATELY UNDER ITEM 832.
- | RRFB CLEARANCE TIME |             |               |
|---------------------|-------------|---------------|
| APPROACH            | LENGTH (ft) | CLEARANCE (s) |
| LOCATION 1          | 40          | 14            |
| LOCATION 2          | 36          | 12            |
| LOCATION 3          | 34          | 12            |

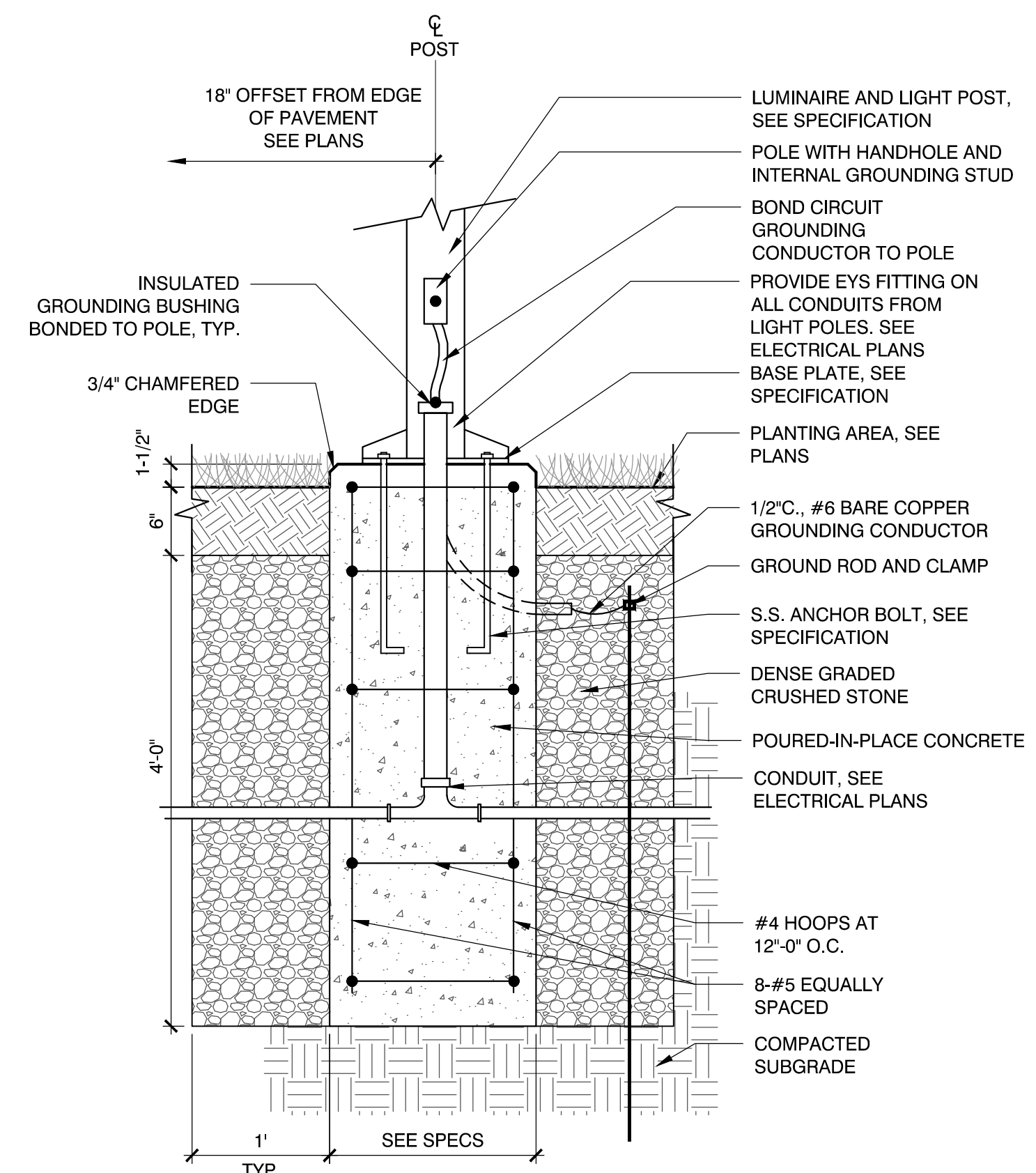

**2 LIGHT POST FOOTING**  
SCALE: N.T.S.

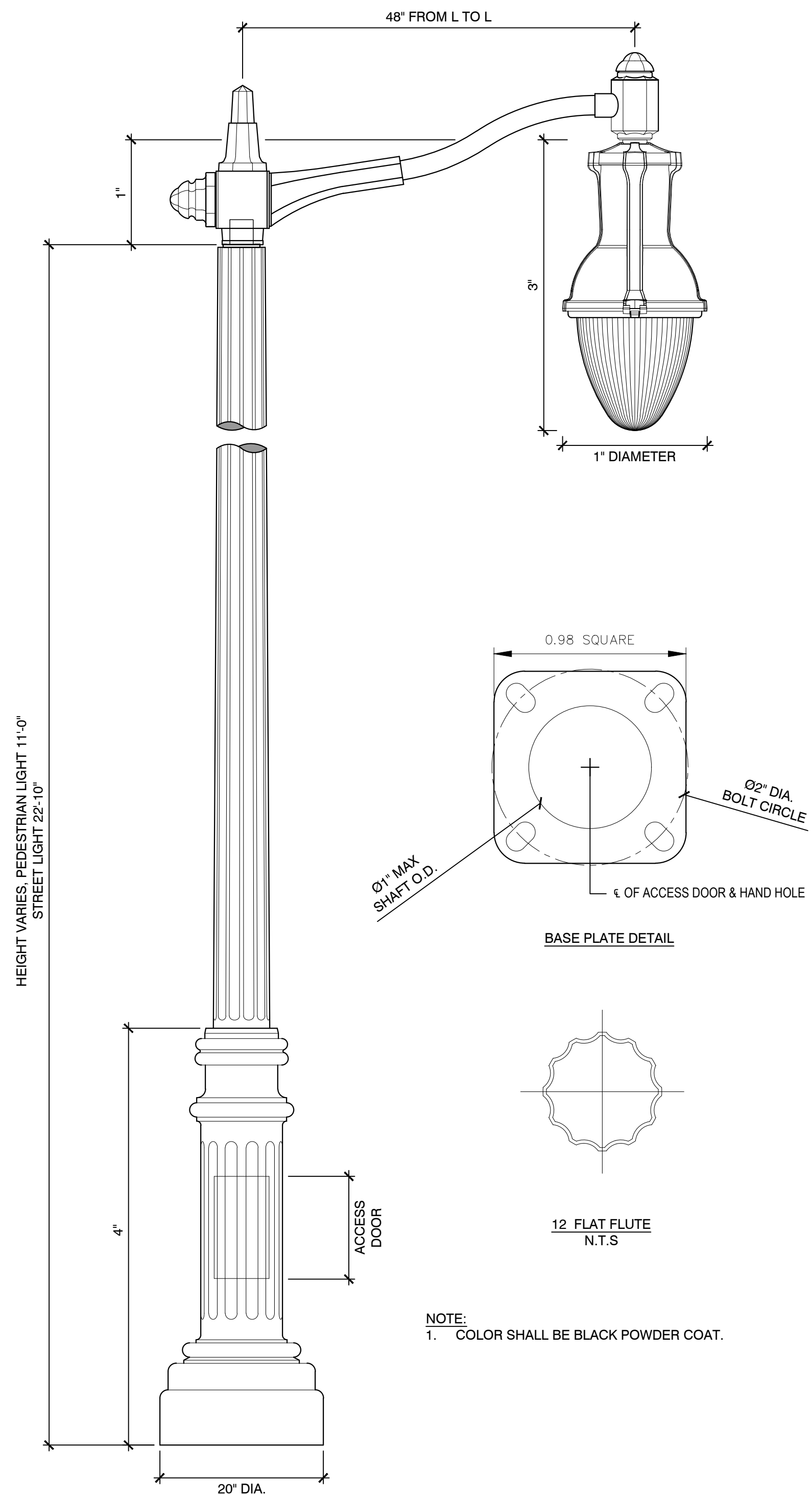

**3 PEDESTRIAN AND STREET LIGHT**  
SCALE: N.T.S.

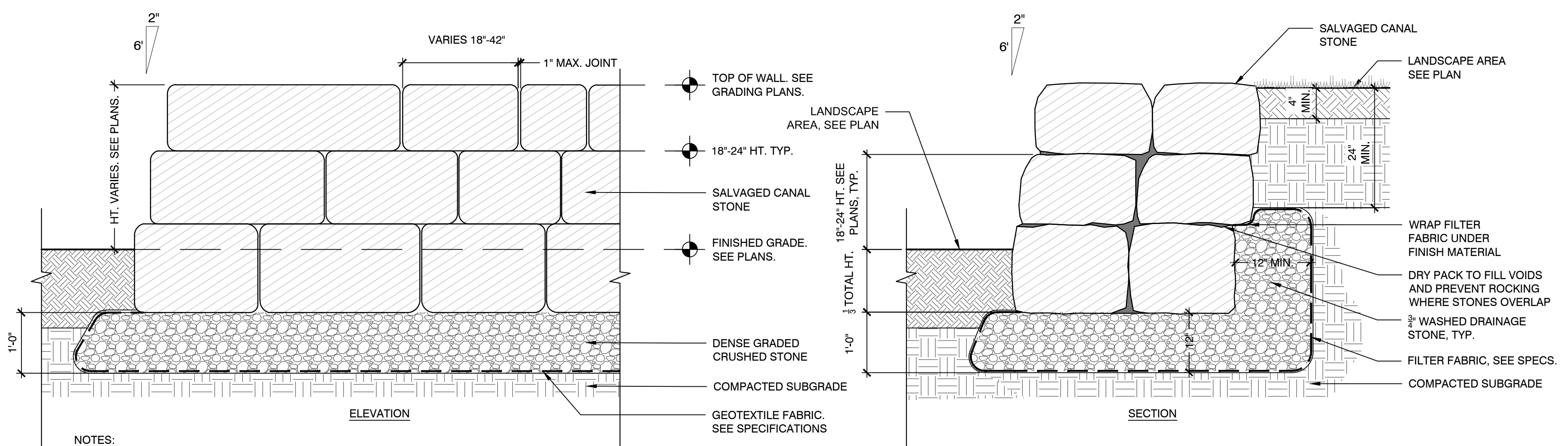

- NOTES:**
- BLOCK SELECTION SHALL BE BY OWNER'S REPRESENTATIVE.
  - FINAL LOCATION AND LAYOUT SHALL BE BY OWNER'S REPRESENTATIVE IN FIELD. CONTRACTOR SHALL ASSUME PLACEMENT OF EACH BLOCK A MINIMUM OF 3 TIMES.
  - CONTRACTOR SHALL PROVIDE 6\"/>

**4 SALVAGED CANAL STONE RETAINING WALL**  
SCALE: N.T.S.

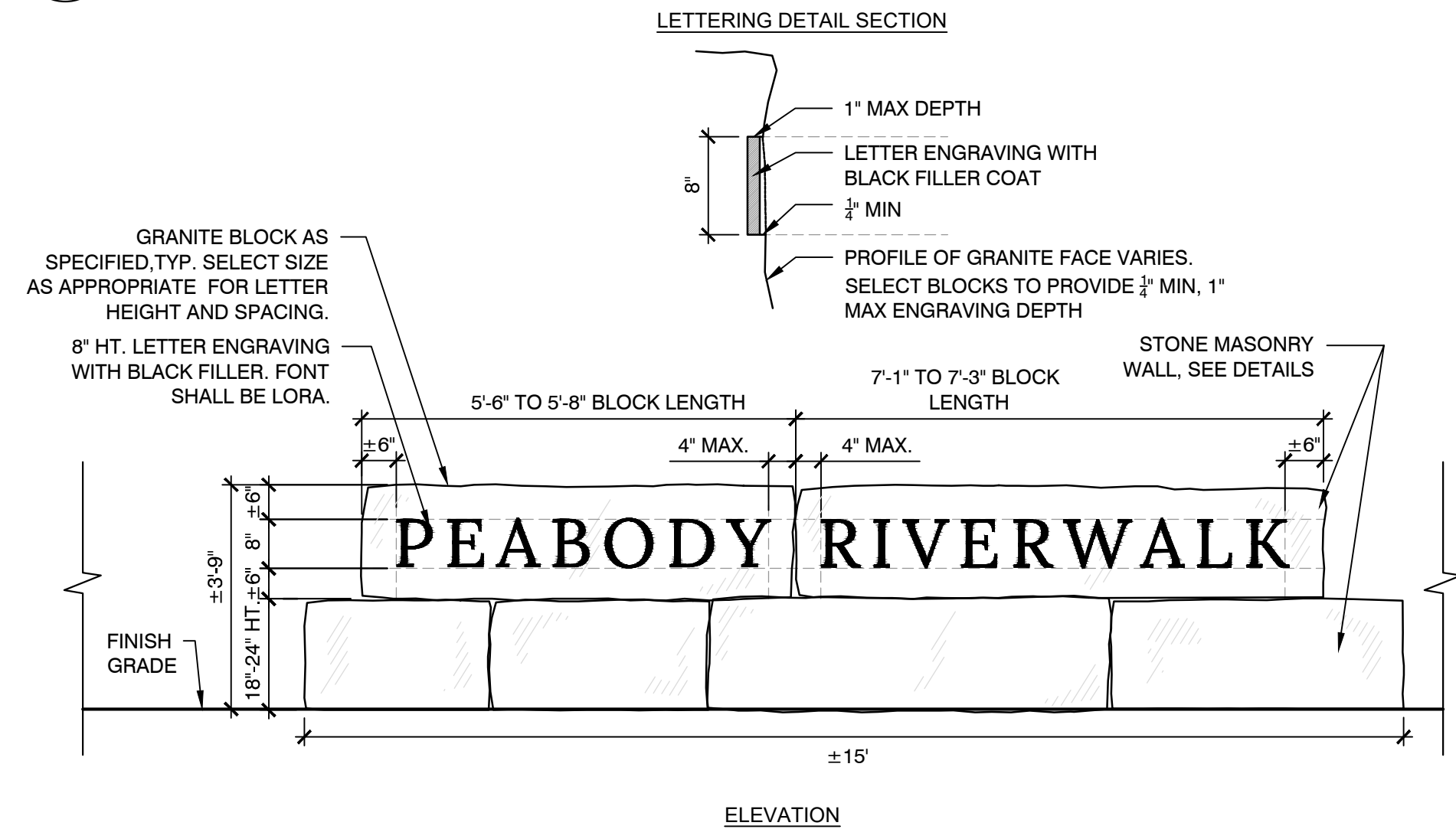

**5 GRANITE BLOCK RIVERWALK ENTRY SIGN**  
SCALE: N.T.S.



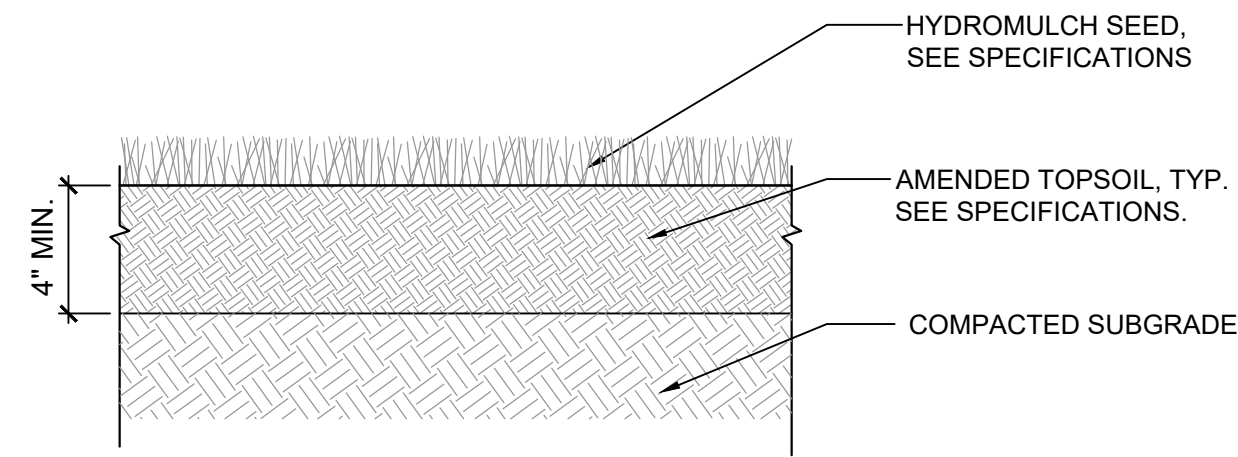

**1 LOAM AND SEED**  
SCALE: N.T.S.

GROUND COVER SPACING TABLE

PLANT SPACING "A"	ROW SPACING "B"	PLANTS	AREA UNIT
6" O.C.	5.2"	4.61	1 SQ. FT.
8" O.C.	6.93"	2.6	1 SQ. FT.
10" O.C.	8.66"	1.66	1 SQ. FT.
12" O.C.	10.4"	1.15	1 SQ. FT.

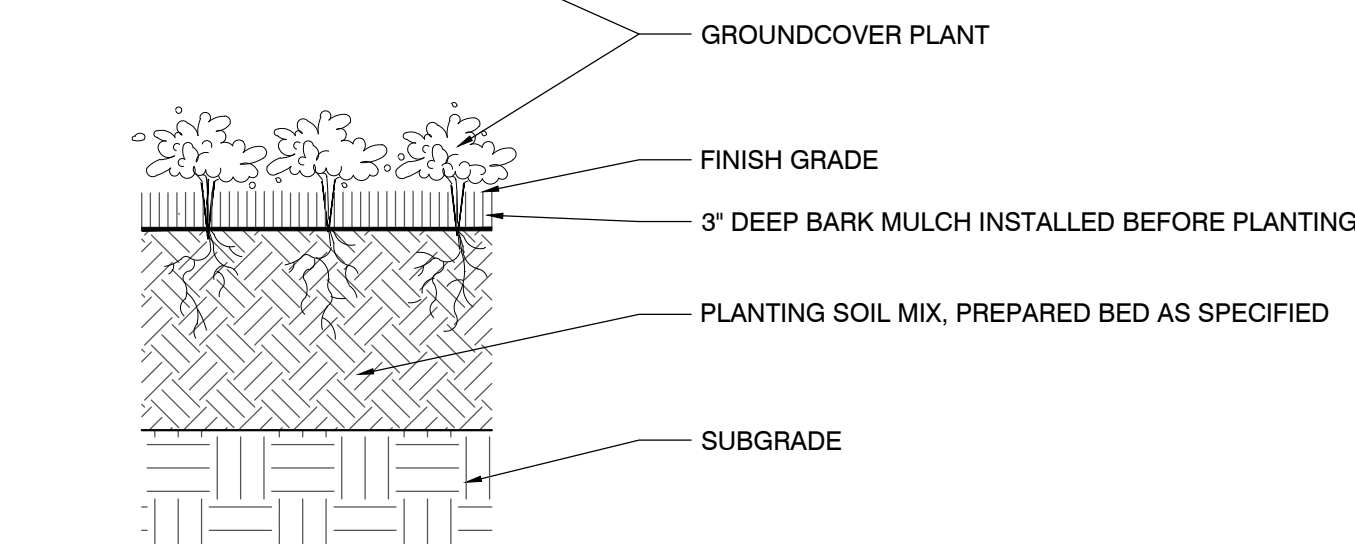

- NOTES:  
1. ALL GROUND COVER TO BE PLANTED IN TRIANGULAR PATTERN. SEE DETAIL PLAN AND GROUND COVER SPACING TABLE.  
2. JUTE EROSION CONTROL MAT TO BE USED ON ALL SLOPES GREATER THAN 3:1

**2 GROUND COVER PLANTING**  
SCALE: N.T.S.

HERBACEOUS PERENNIAL & FERN SPACING TABLE

PLANT SPACING "A"	PLANT SPACING "B"	PLANTS	AREA UNIT
6" O.C.	5.2"	4.61	1 SQ. FT.
8" O.C.	6.93"	2.6	1 SQ. FT.
10" O.C.	8.66"	1.66	1 SQ. FT.
12" O.C.	10.4"	1.15	1 SQ. FT.

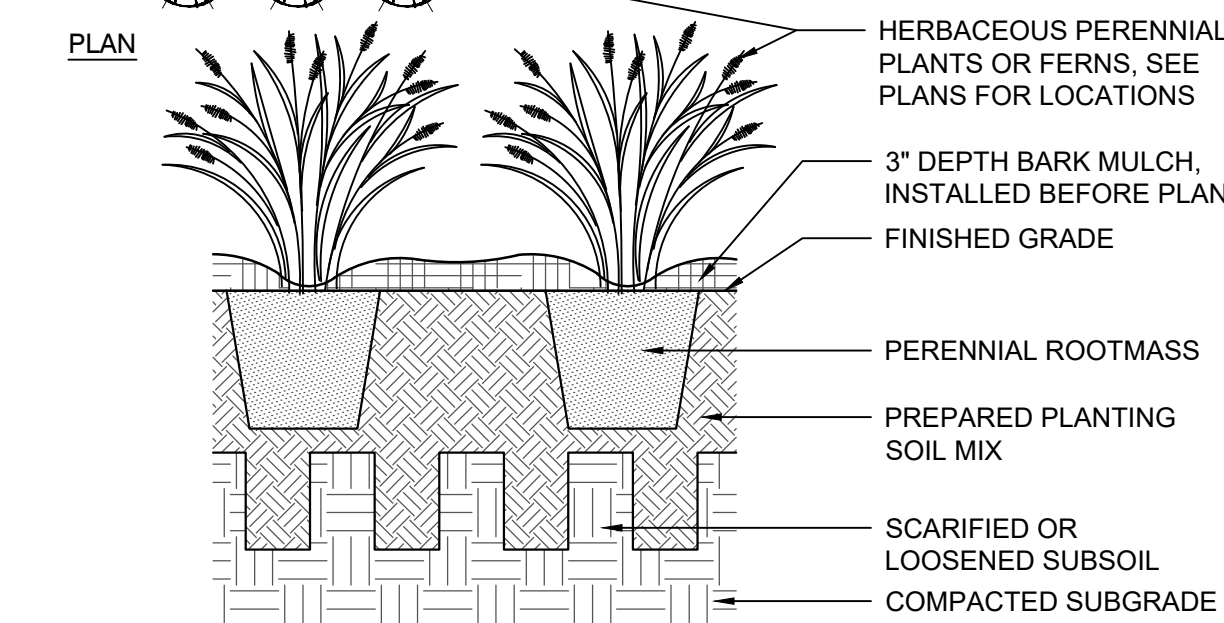

- NOTES:  
1. ALL GROUND COVERS TO BE PLANTED IN TRIANGULAR PATTERN. SEE PLANTING SCHEDULE FOR SPACING.

**3 HERBACEOUS PERENNIAL**  
SCALE: N.T.S.

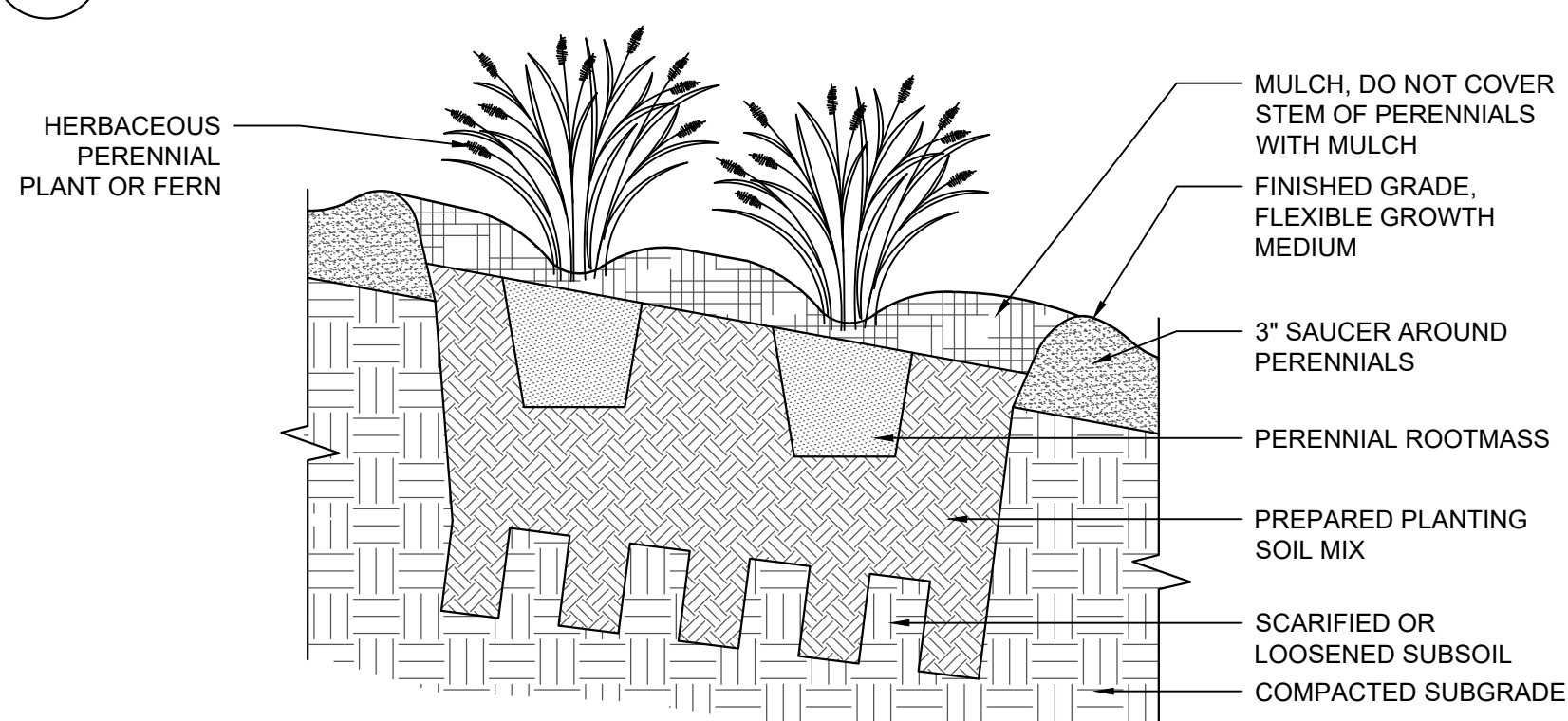

- NOTES:  
1. SEE GRADING PLAN FOR SLOPE GRADE.  
2. ALL MULCH MUST BE DARK IN COLOR. PROVIDE SAMPLE PRIOR TO INSTALLATION TO BE APPROVED BY OWNER'S REPRESENTATIVE.

**4 HERBACEOUS PERENNIAL ON SLOPE**  
SCALE: N.T.S.

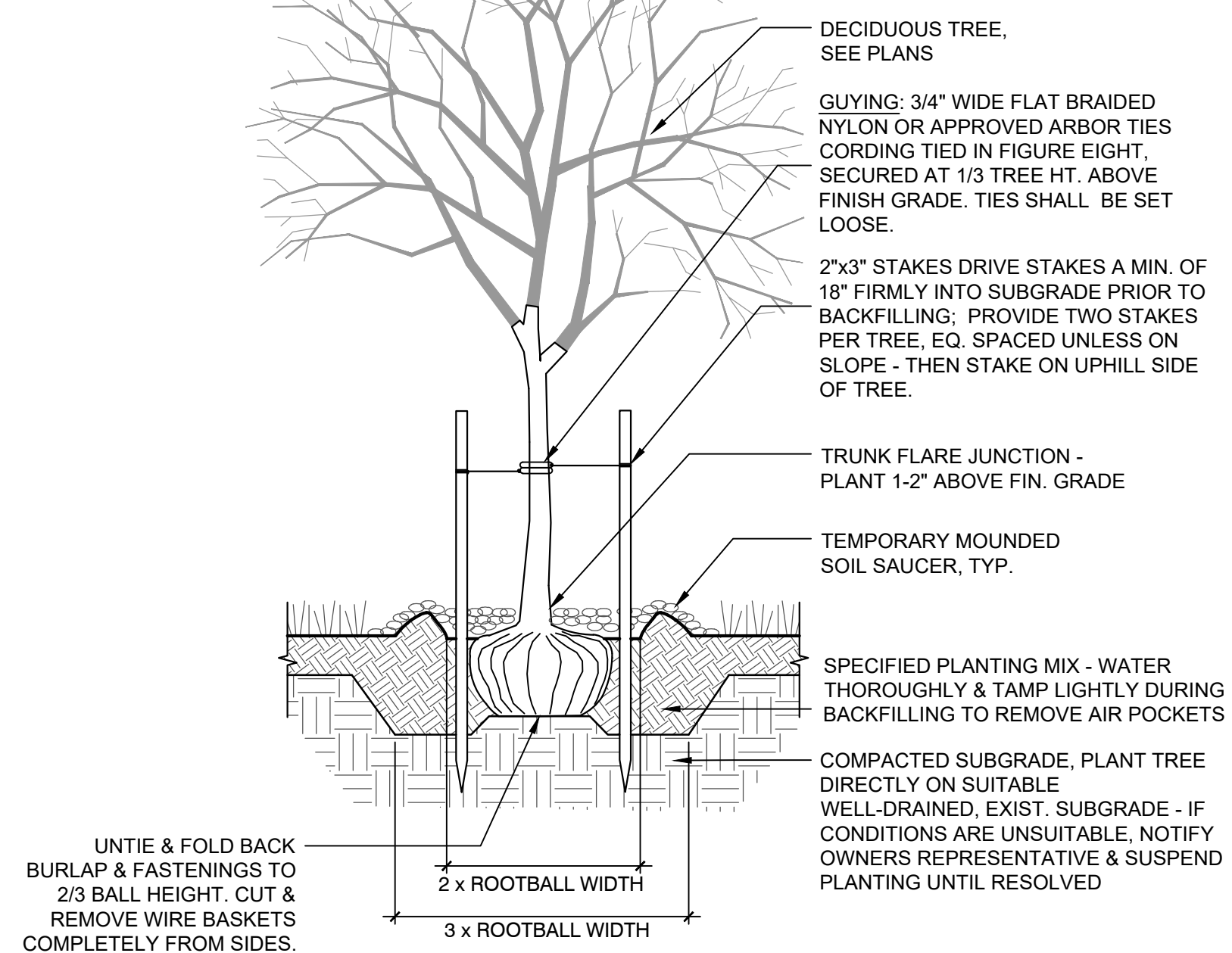
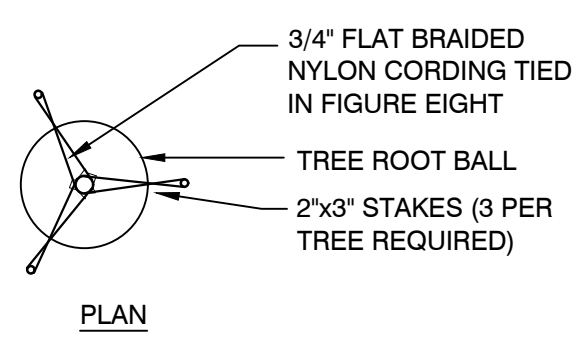

**5 TREE PLANTING AND STAKING - DECIDUOUS**  
SCALE: N.T.S.

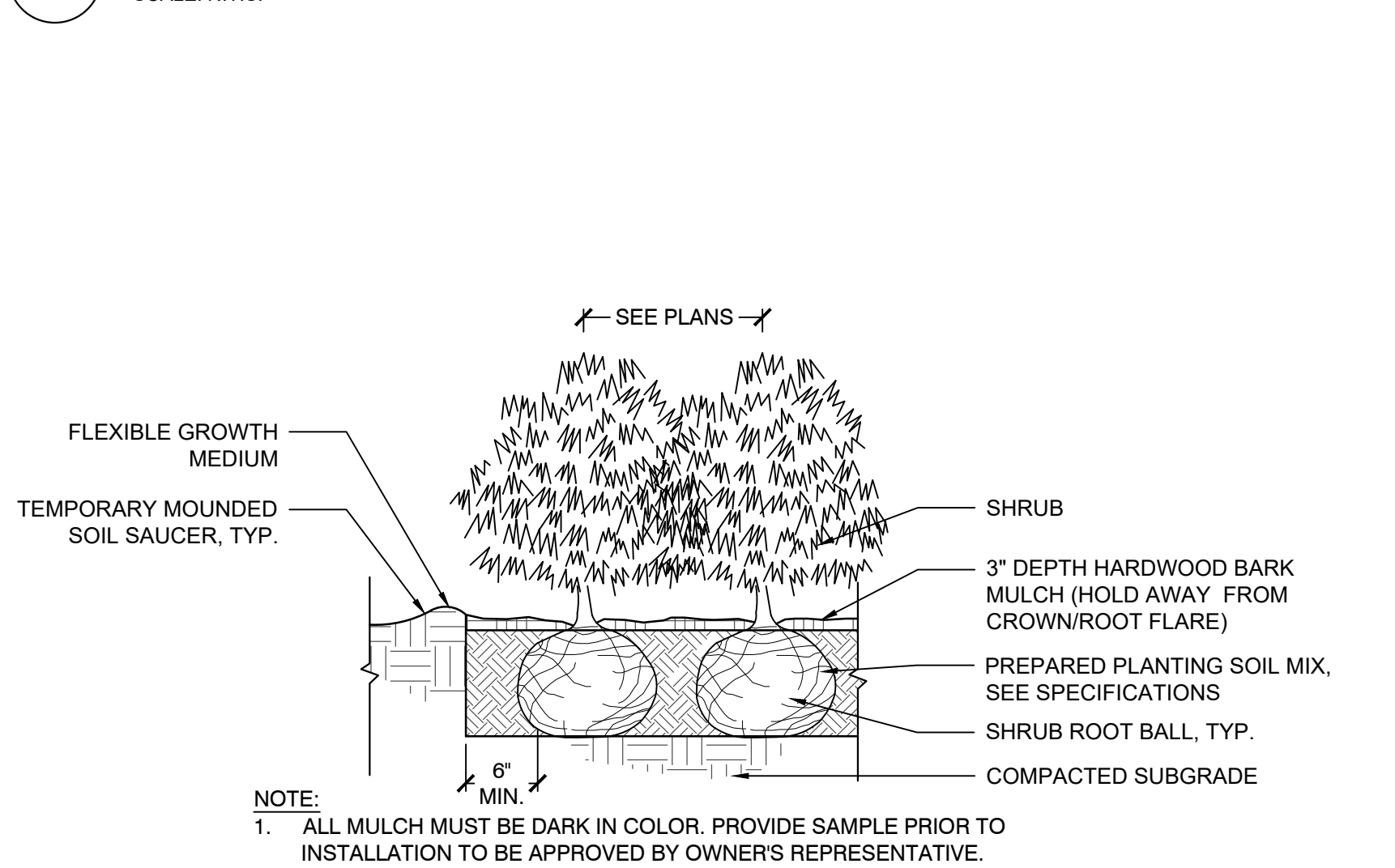

**6 SHRUB PLANTING**  
SCALE: N.T.S.

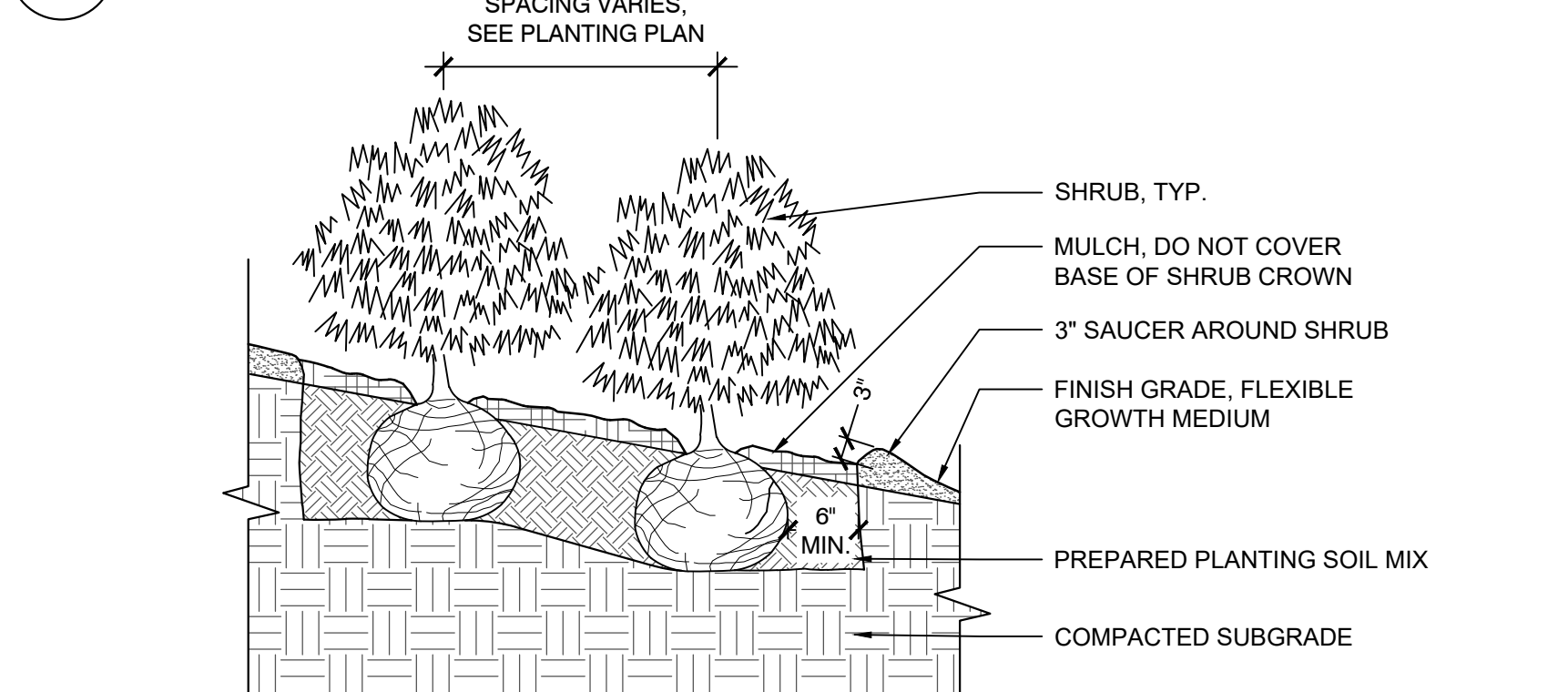

**7 SHRUB PLANTING ON SLOPE**  
SCALE: N.T.S.

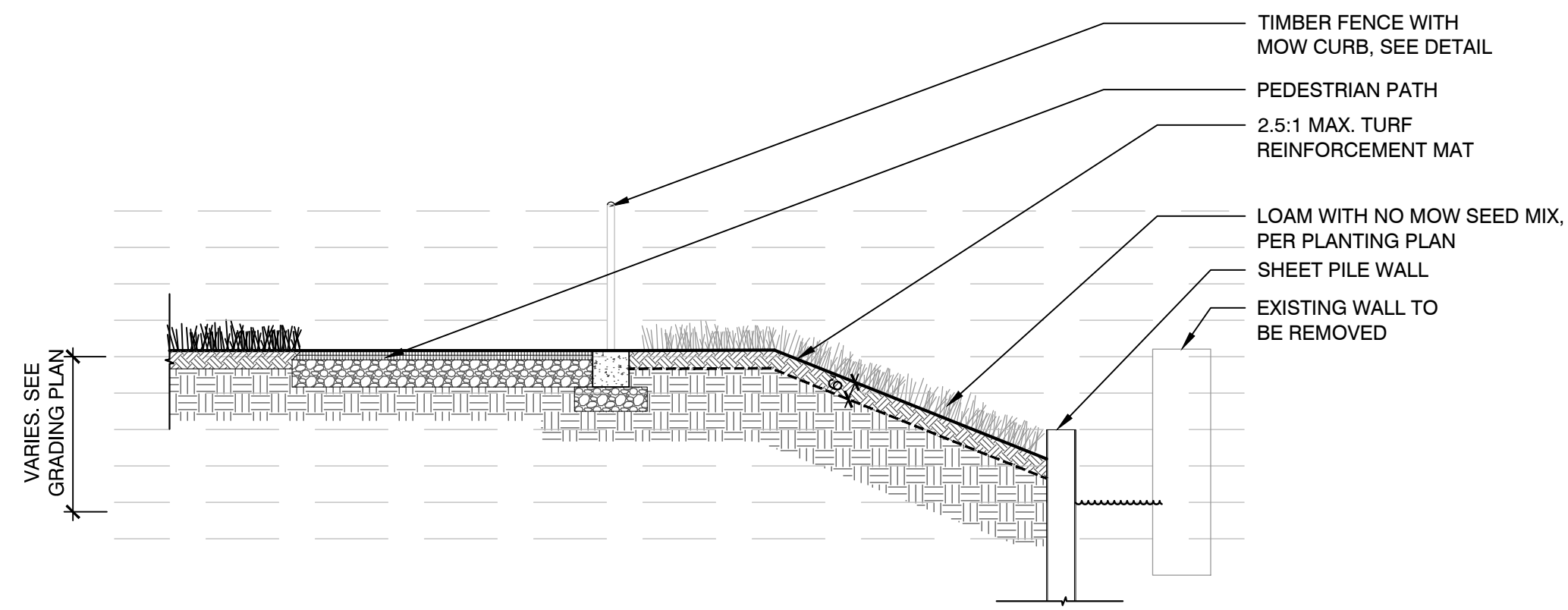

**8 SLOPE WITH TURF REINFORCEMENT MAT, LOAM AND EROSION CONTROL**  
SCALE: N.T.S.

Consultants:

Revisions:

No.	Date	Description

Seal:

Key Plan:

Issued For:  
**75% CONSTRUCTION DOCUMENTS**  
- NOT FOR CONSTRUCTION -

Scale: N.T.S.  
Date: APRIL 2021  
Drawn By: FD, TY, SG  
Reviewed By: CC  
Approved By: CFR  
W&S Project No.: ENG20-0145  
W&S File No.:

Drawing Title:  
**CONSTRUCTION DETAILS**

Sheet Number:  
**L507**



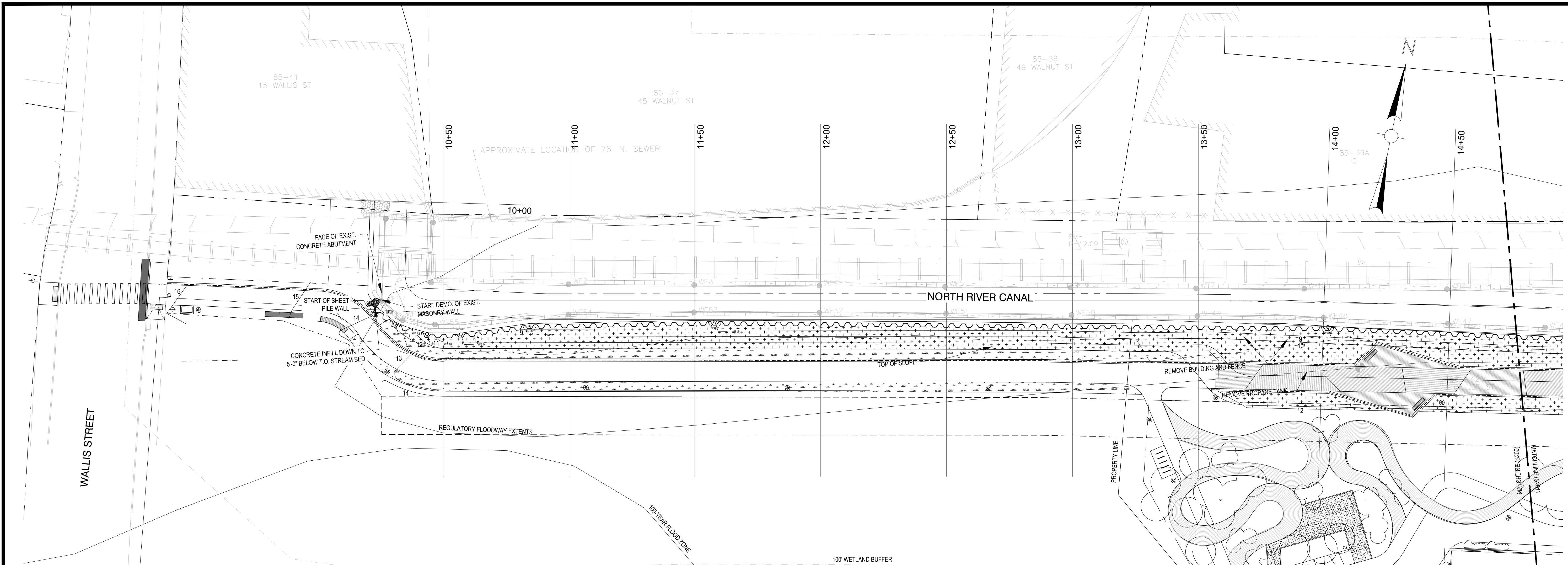

PLAN  
SCALE: 1" = 20'-0"

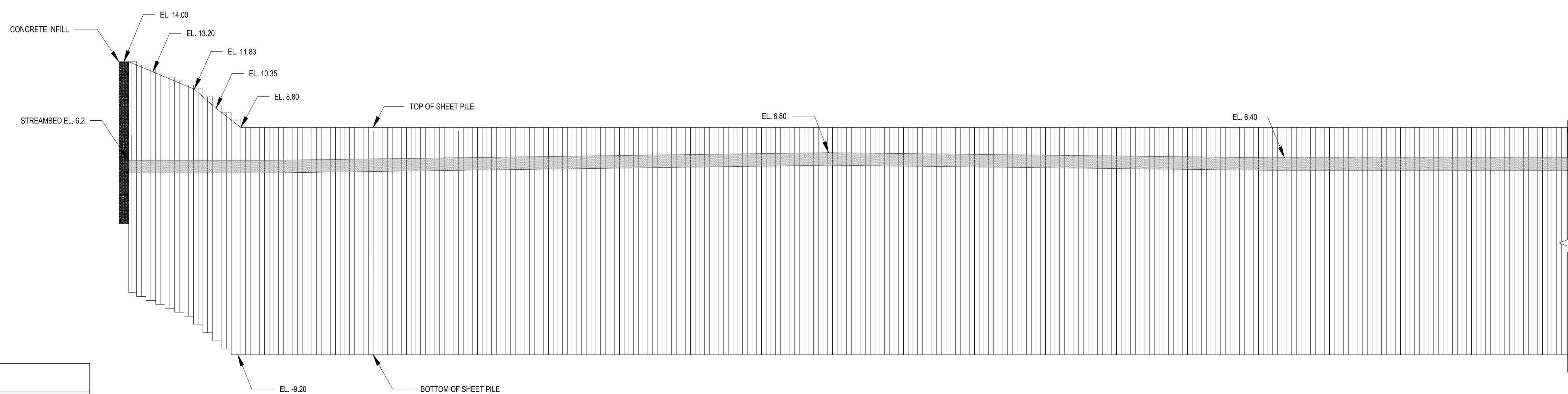

ELEVATION - SHEET PILE WALL  
HORIZONTAL SCALE: 1" = 20'  
VERTICAL SCALE: 1" = 1'

WORKING POINT TABLE		
WP #	NORTHING	EASTING
1	3120217.9090	-160733.36930
2	3120209.38300	-160722.86670
3	3120205.11650	-160710.25810
4	3120204.84670	-160696.80040
5	3120208.31540	-160669.47910
6	3120208.85690	-160595.88510
7	3120204.00420	-160352.44290

Project:  
**PEABODY RIVERWALK**



RIVERWALK PARK DESIGN PLANS  
CALLER STREET - HOWLEY STREET  
PEABODY, MA. 01960

**Weston & Sampson**  
WESTON & SAMPSON ENGINEERS, INC.  
85 DEVONSHIRE STREET, 3RD FLOOR  
BOSTON, MA 02109  
617-412-4480  
www.westonandsampson.com

Consultants:

Revisions:

No.	Date	Description

Seal:

Issued For:  
**75% DESIGN PLANS**

Scale: 1" = 20'  
Date: 03/11/2021  
Drawn By: HLB  
Reviewed By: SYC  
Approved By: SRB

W&S Project No.: ENG20-0145  
W&S File No.:

Drawing Title:  
**PROPOSED LAYOUT PLAN I**

Sheet Number:  
**S200**

P:\Projects\2020\0145\0145-0145-0145-0145-0145.dwg



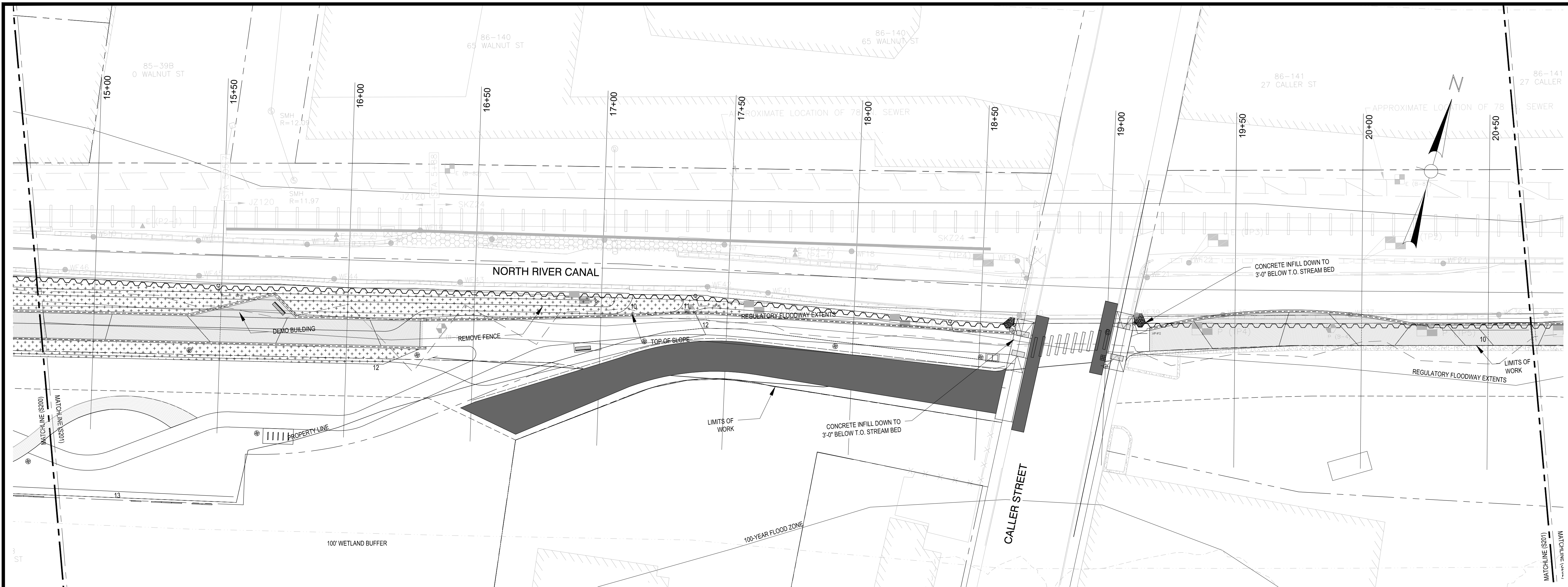

PLAN  
SCALE: 1" = 20'-0"

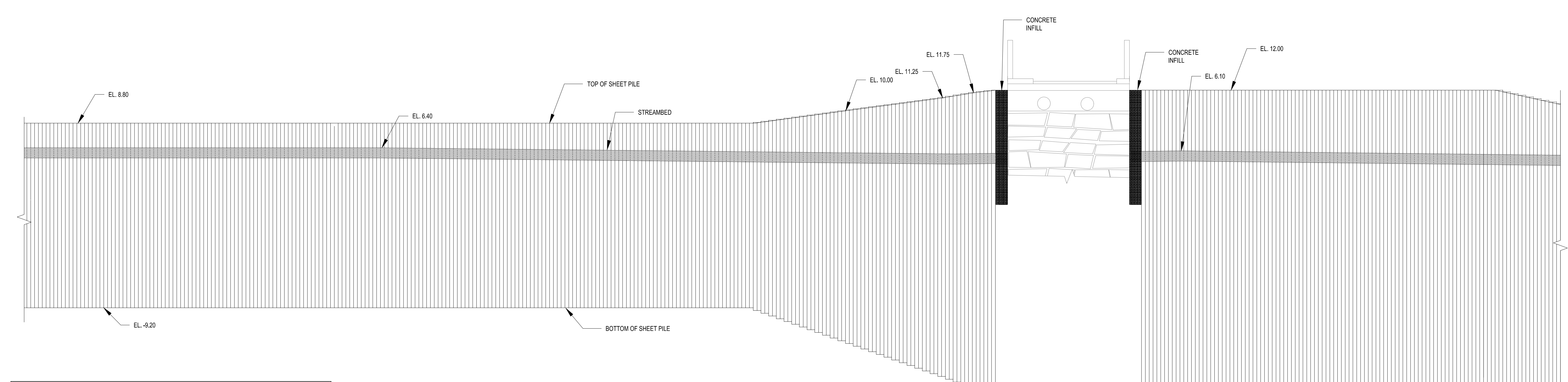

ELEVATION - SHEET PILE WALL  
HORIZONTAL SCALE: 1" = 20'  
VERTICAL SCALE: 1" = 4'

WORKING POINT TABLE		
WP #	NORTHING	EASTING
8	3120195.9003	-160205.6708
9	3120189.8658	-160017.4002
10	3120178.6442	-159916.9494
11	3120177.0231	-159891.7712
12	3120177.0638	-159844.1990

Project:  
**PEABODY RIVERWALK**

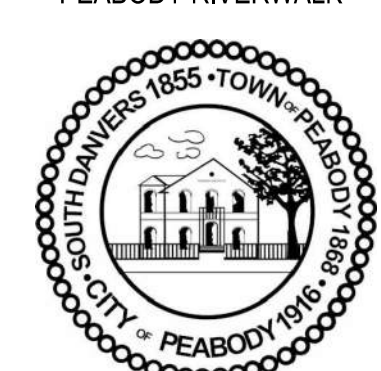

RIVERWALK PARK DESIGN PLANS  
CALLER STREET - HOWLEY STREET  
PEABODY, MA. 01960

**Weston & Sampson**  
WESTON & SAMPSON ENGINEERS, INC.  
85 DEVONSHIRE STREET, 3RD FLOOR  
BOSTON, MA 02109  
617-412-4480  
www.westonandsampson.com

Consultants:

Revisions:

No.	Date	Description

Seal:

Issued For:  
**75% DESIGN PLANS**

Scale: 1" = 20'  
Date: 03/11/2021  
Drawn By: HLB  
Reviewed By: SYC  
Approved By: SRB

W&S Project No.: ENG20-0145  
W&S File No.:

Drawing Title:  
**PROPOSED LAYOUT PLAN II**

Sheet Number:  
**S201**



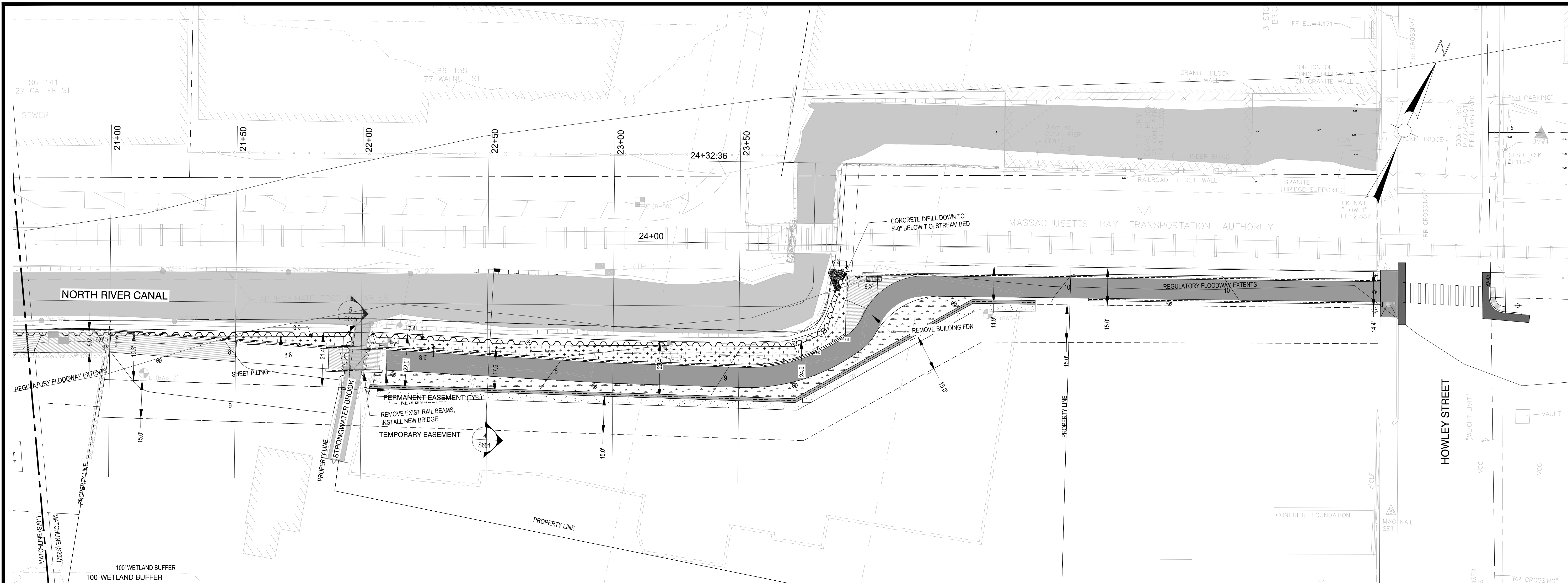

PLAN  
SCALE: 1" = 20'-0"

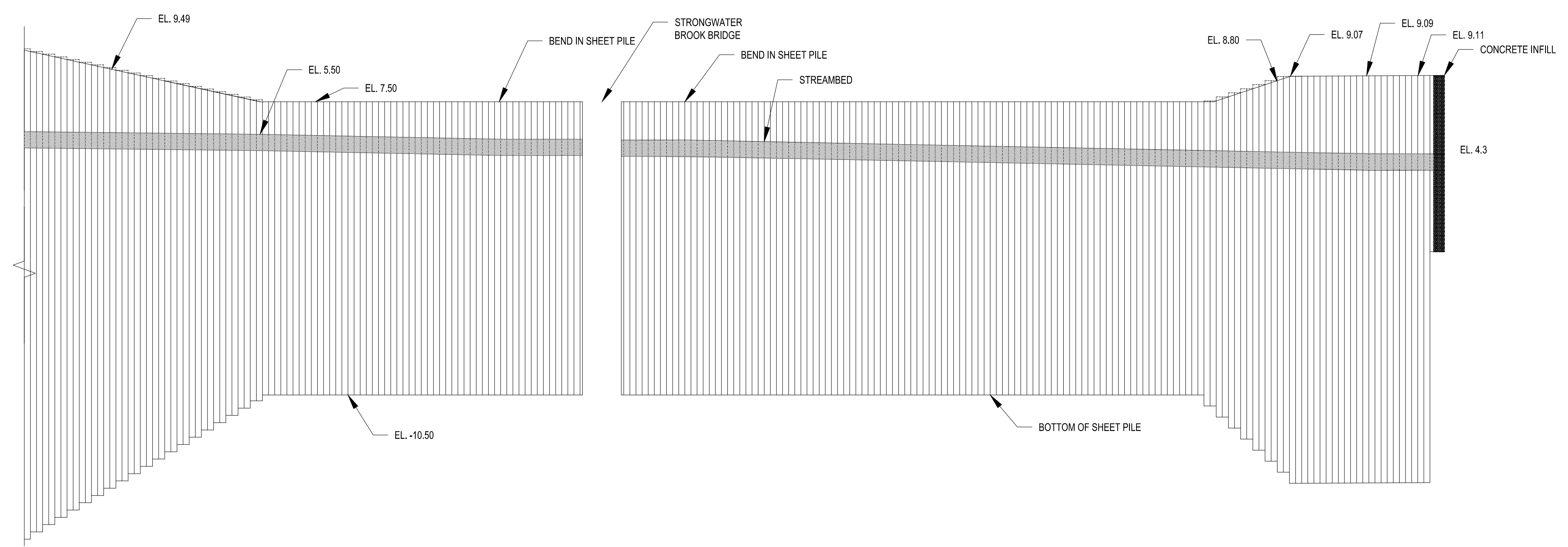

ELEVATION - SHEET PILE WALL  
HORIZONTAL SCALE: 1" = 20'  
VERTICAL SCALE: 1" = 1'

WORKING POINT TABLE		
WP #	NORTHING	EASTING
13	3120173.1015	-159559.3888
14	3120172.8502	-159550.1588
15	3120168.9470	-159488.2683
16	3120167.2228	-159382.9704
17	3120172.3121	-159371.1687
18	3120195.6586	-159363.2979

Project:  
**PEABODY RIVERWALK**

RIVERWALK PARK DESIGN PLANS  
CALLER STREET - HOWLEY STREET  
PEABODY, MA. 01960

**Weston & Sampson**  
WESTON & SAMPSON ENGINEERS, INC.  
85 DEVONSHIRE STREET, 3RD FLOOR  
BOSTON, MA 02109  
617-412-4480  
www.westonandsampson.com

Consultants:

Revisions:

No.	Date	Description

Seal:

Issued For:  
**75% DESIGN PLANS**

Scale: 1" = 20'  
Date: 03/11/2021  
Drawn By: HLB  
Reviewed By: SYC  
Approved By: SRB

W&S Project No.: ENG20-0145  
W&S File No.:

Drawing Title:  
**PROPOSED LAYOUT  
PLAN III**

Sheet Number:  
**S202**

Consultants:

Revisions:

No.	Date	Description

Seal:

Issued For:  
**75% DESIGN PLANS**

Scale: AS NOTED  
Date: 03/11/2021  
Drawn By: HLB  
Reviewed By: SYC  
Approved By: SRB

W&S Project No.: ENG20-0145  
W&S File No.:

Drawing Title:  
**WALL SECTIONS AND DETAILS I**

Sheet Number:  
**S600**

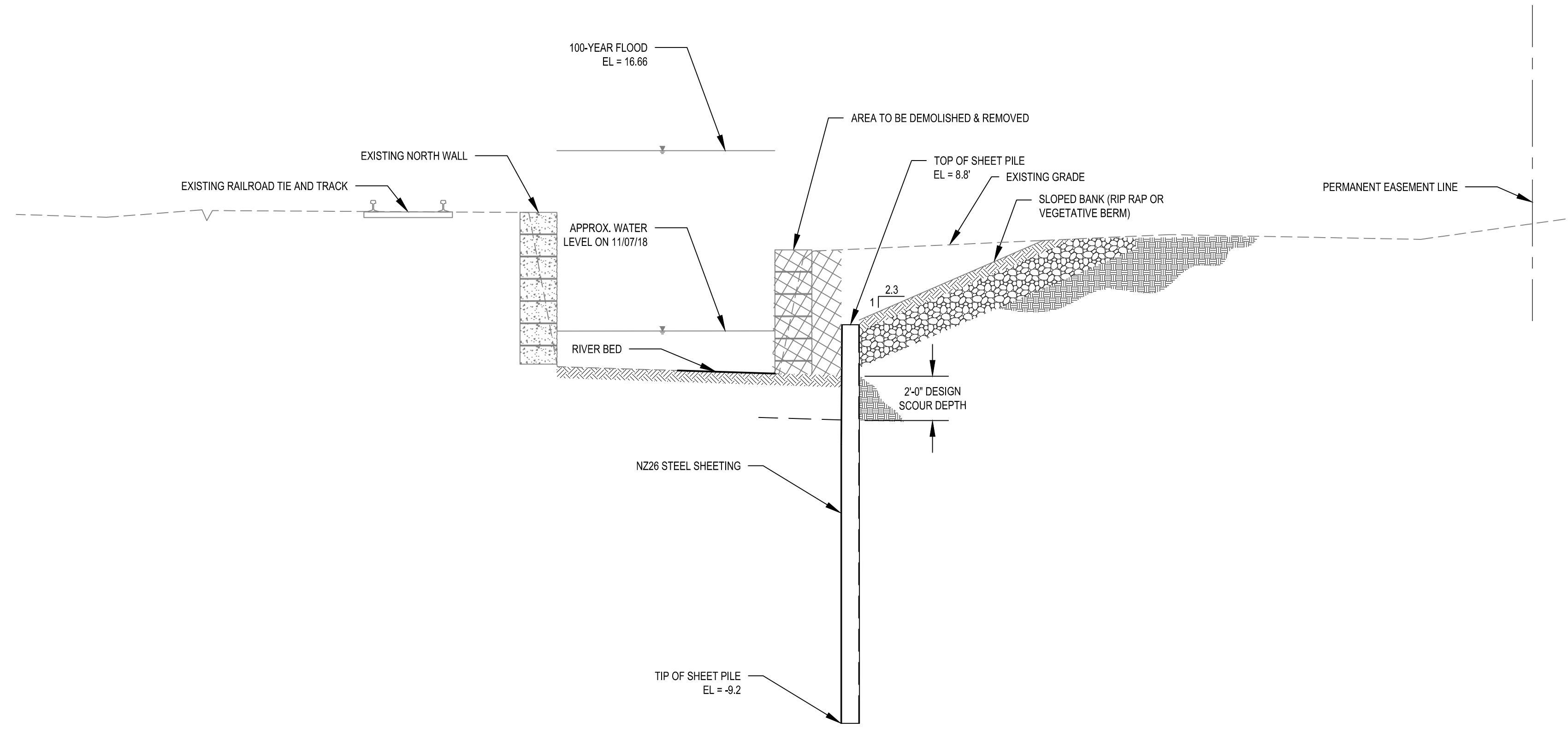

**1 SECTION @ STATION 11+50**  
SCALE: 1"=4'-0"

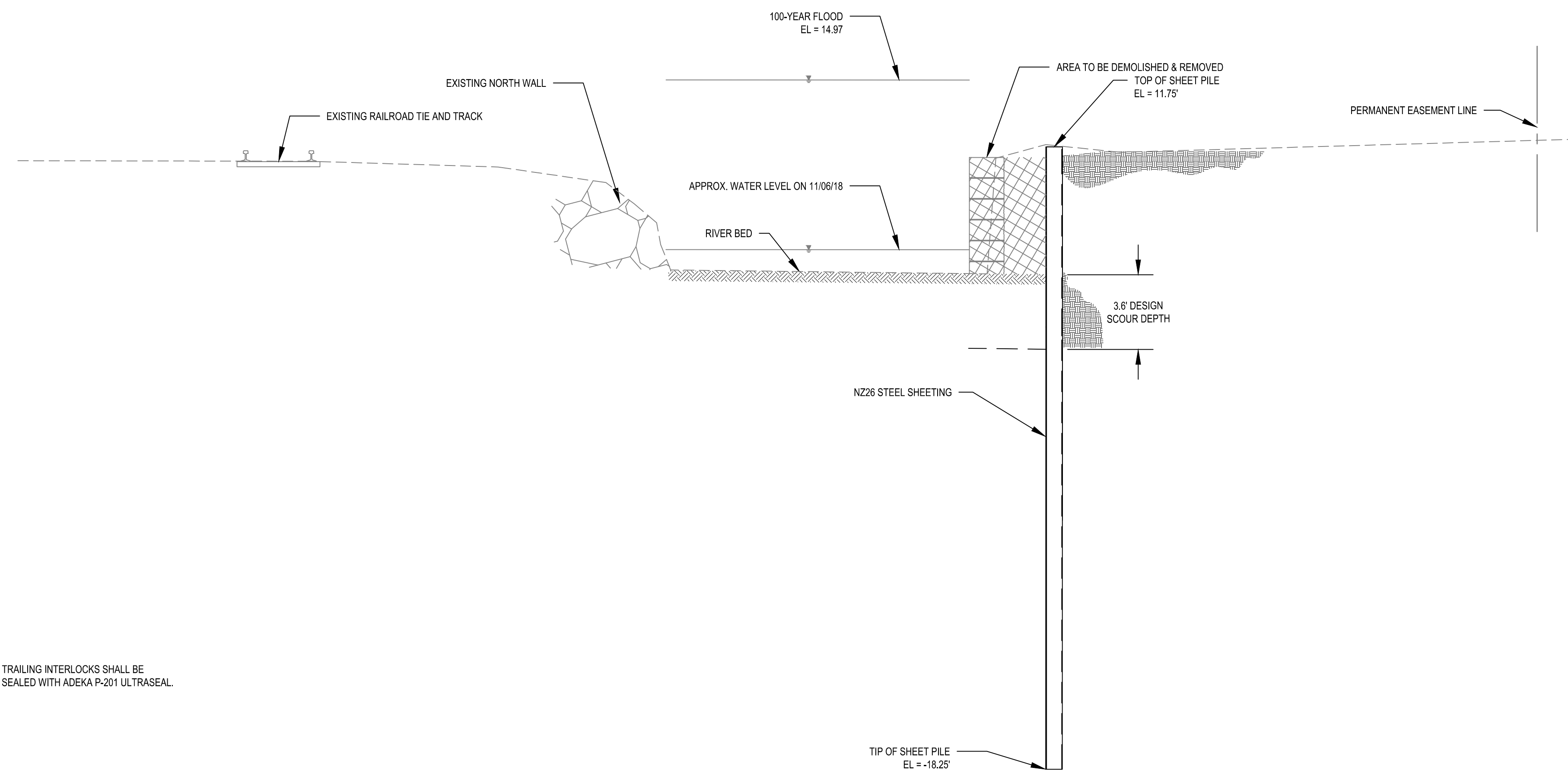

**2 SECTION @ STATION 18+50**  
SCALE: 1"=4'-0"

**NZ/PZ HOT ROLLED STEEL SHEET PILE**  
NTS

CENTER INTERLOCKS SHALL BE WELDED TO CREATE DOUBLE SHEET PILE SECTIONS OR ALL SINGLE SHEETS SHALL BE SEALED WITH ADEKA P-201 ULTRASEAL OR APPROVED EQUIVALENT. CONTRACTOR TO VERIFY PREFERRED METHOD TO DESIGN CONTRACTOR (WELDED PAIRS OR JOINT SEALANT) PRIOR TO DELIVERY OF SHEETING TO THE SITE.

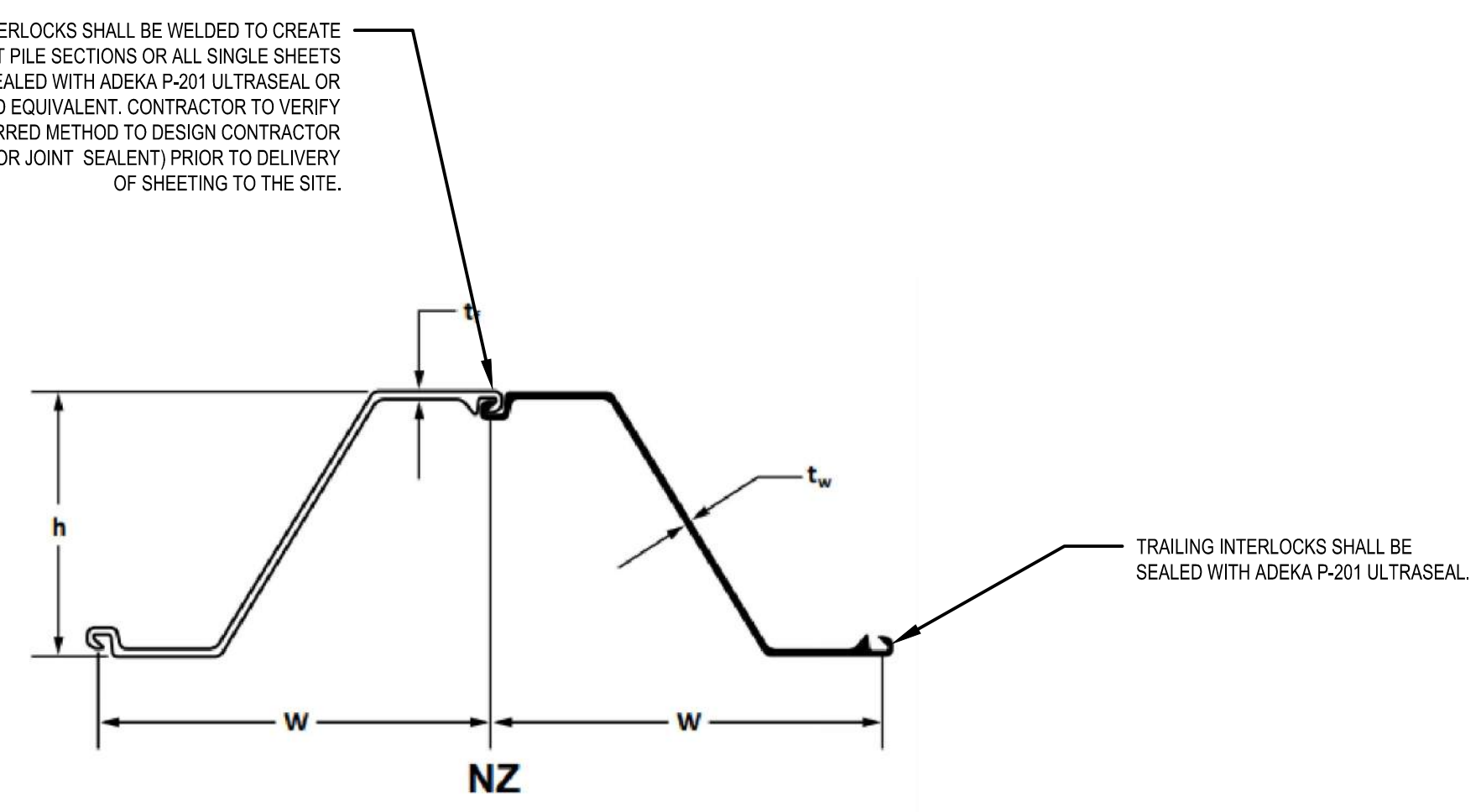

SECTION	WIDTH (W) (IN)	HEIGHT (H) (IN)	THICKNESS		CROSS SECTIONAL AREA (IN <sup>2</sup> /FT)	WEIGHT		SECTION MODULUS		MOMENT OF INERTIA (IN <sup>4</sup> /FT)	COATING AREA	
			FLANGE (T <sub>f</sub> ) (IN)	WEB (T <sub>w</sub> ) (IN)		PILE (LB/FT)	WALL (LB/FT <sup>2</sup> )	ELASTIC (IN <sup>3</sup> /FT)	PLASTIC (IN <sup>3</sup> /FT)		BOTH SIDES (FT <sup>2</sup> /FT) OF SINGLE	WALL SURFACE (FT <sup>2</sup> /FT <sup>2</sup> )
NZ26	27.56	17.32	0.50	0.50	9.08	71	30.99	48.50	57.01	419.90	6.49	1.41



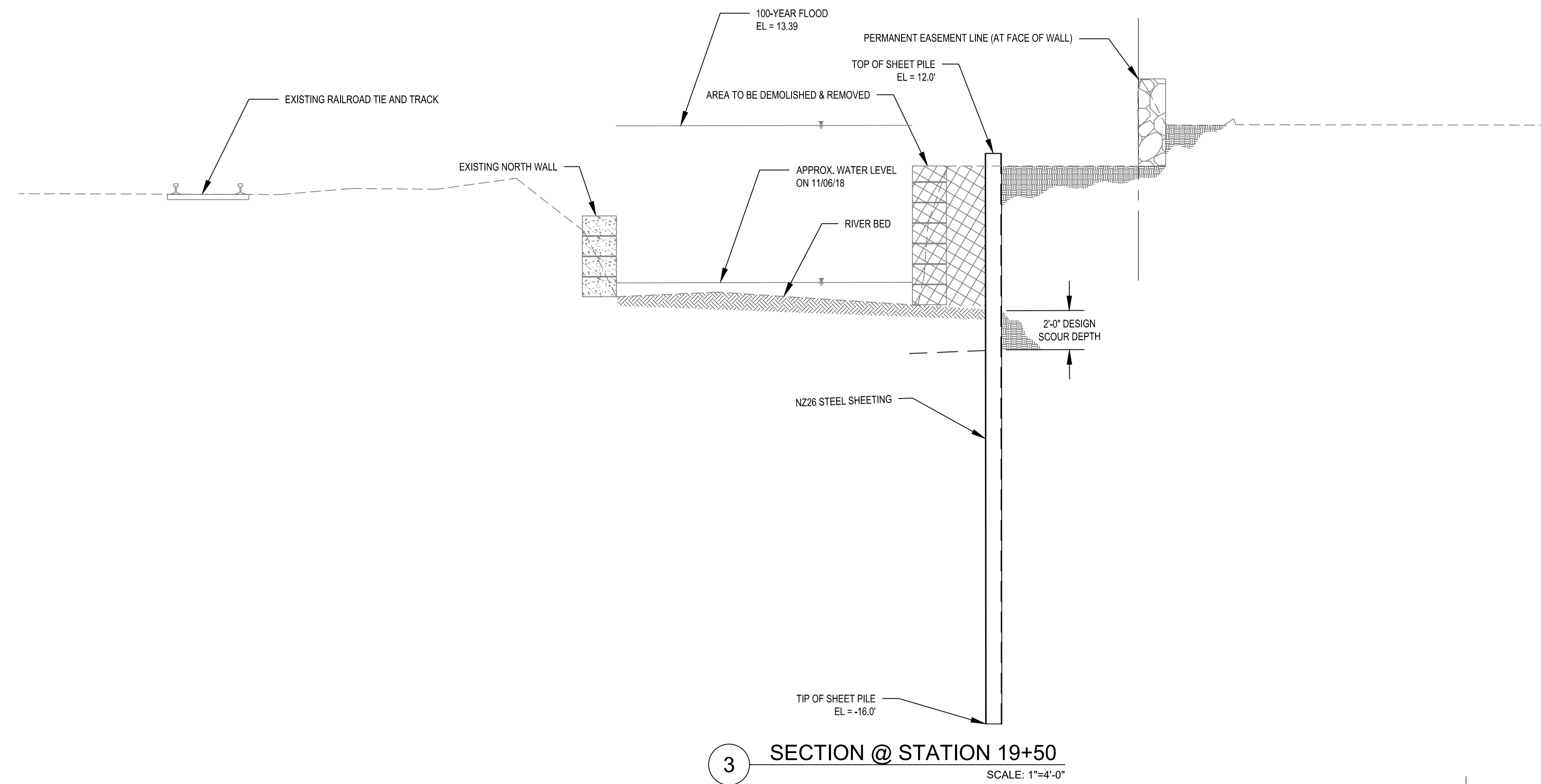

3 SECTION @ STATION 19+50  
SCALE: 1"=4'-0"

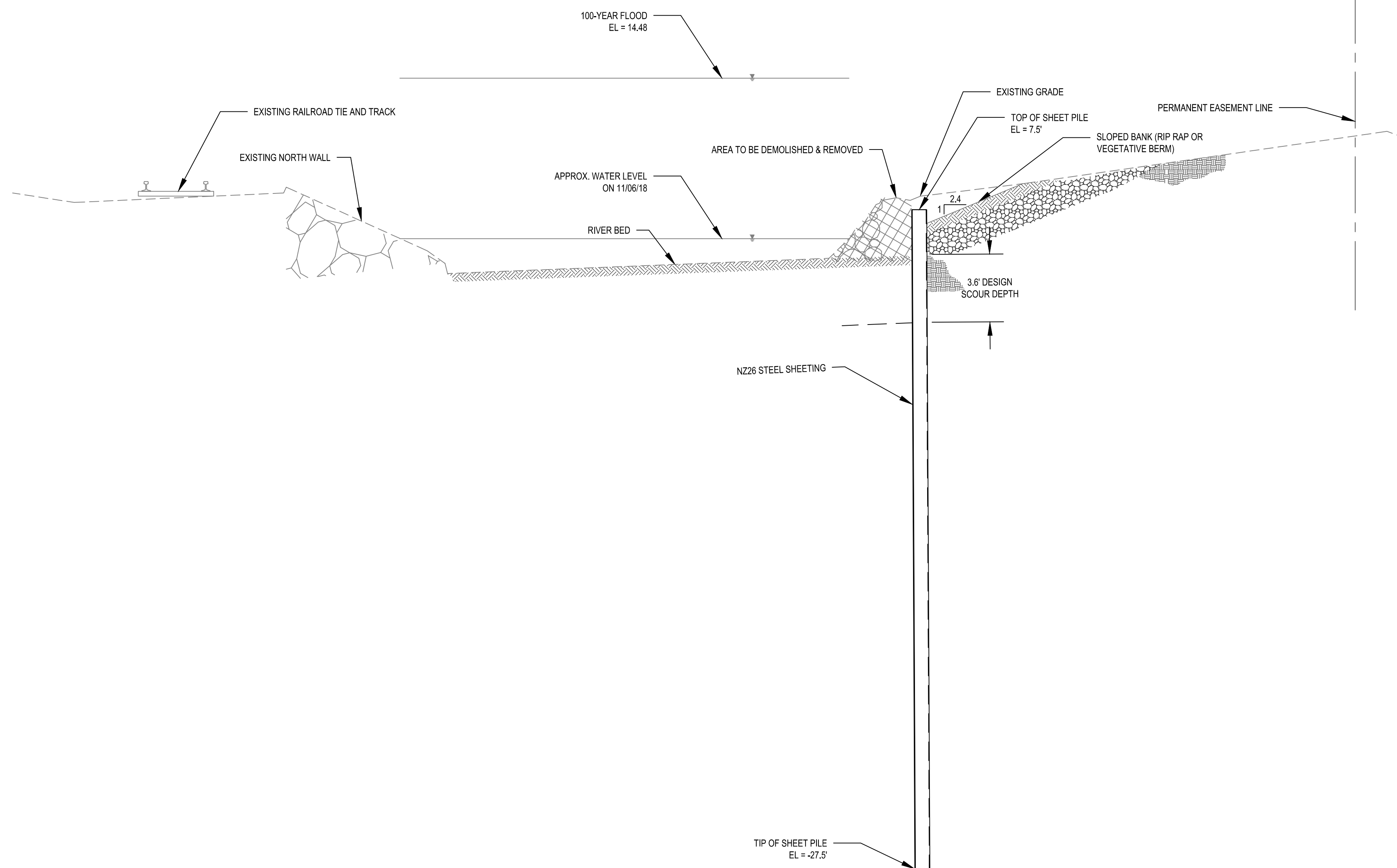

4 SECTION @ STATION 22+50  
SCALE: 1"=4'-0"

Consultants:

Revisions:

No.	Date	Description

Seal:

Issued For:

75% DESIGN PLANS

Scale: AS NOTED  
Date: 03/11/2021  
Drawn By: HLB  
Reviewed By: SYC  
Approved By: SRB

W&S Project No.: ENG20-0145  
W&S File No.:

Drawing Title:  
WALL SECTIONS AND DETAILS II

Sheet Number:  
S601

Revisions:

No.	Date	Description

Seal:

Issued For:

**75% DESIGN PLANS**

Scale: 1" = 20'

Date: 03/11/2021  
Drawn By: HLB  
Reviewed By: SYC  
Approved By: SRB

W&S Project No.: ENG20-0145  
W&S File No.:

Drawing Title:

**OVERLOOK FRAMING  
PLAN, SECTIONS, &  
DETAILS**

Sheet Number:

**S602**

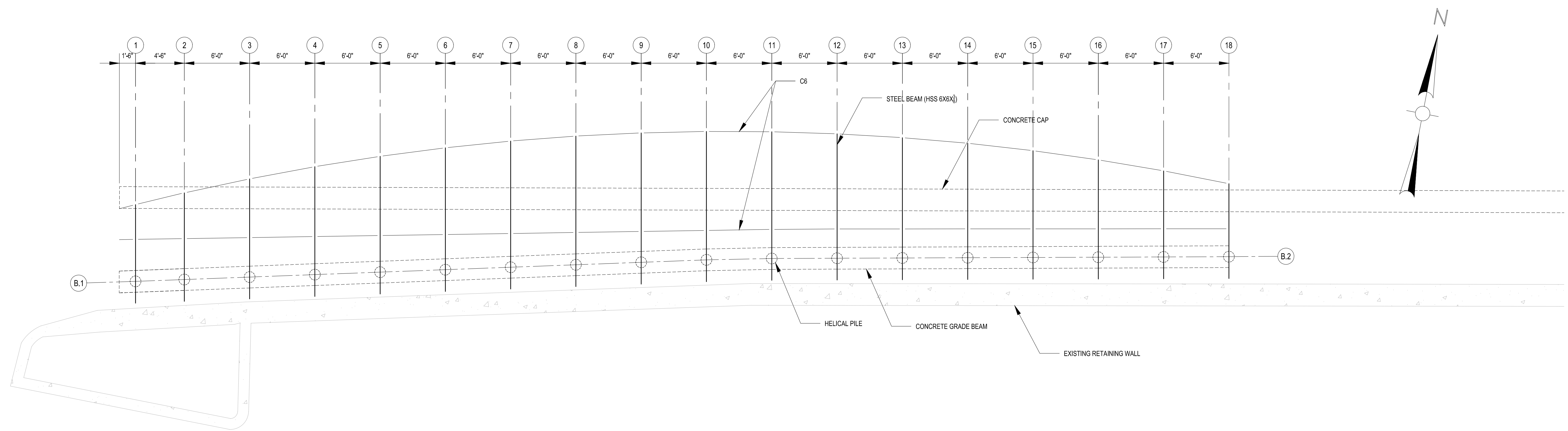

**FRAMING PLAN**  
SCALE: 1" = 5'-0"

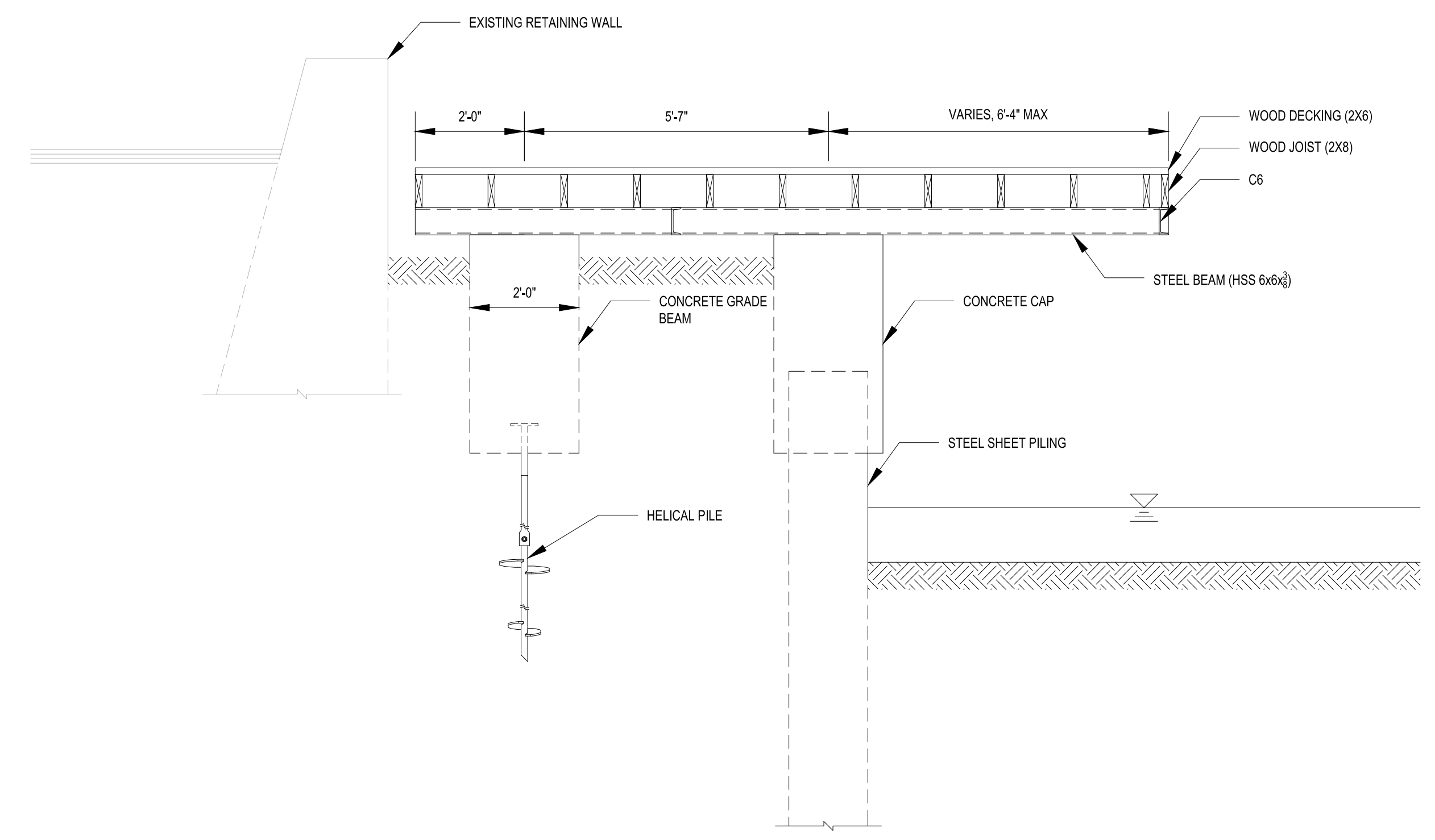

**ELEVATION VIEW**  
SCALE: 1/2" = 1'-0"



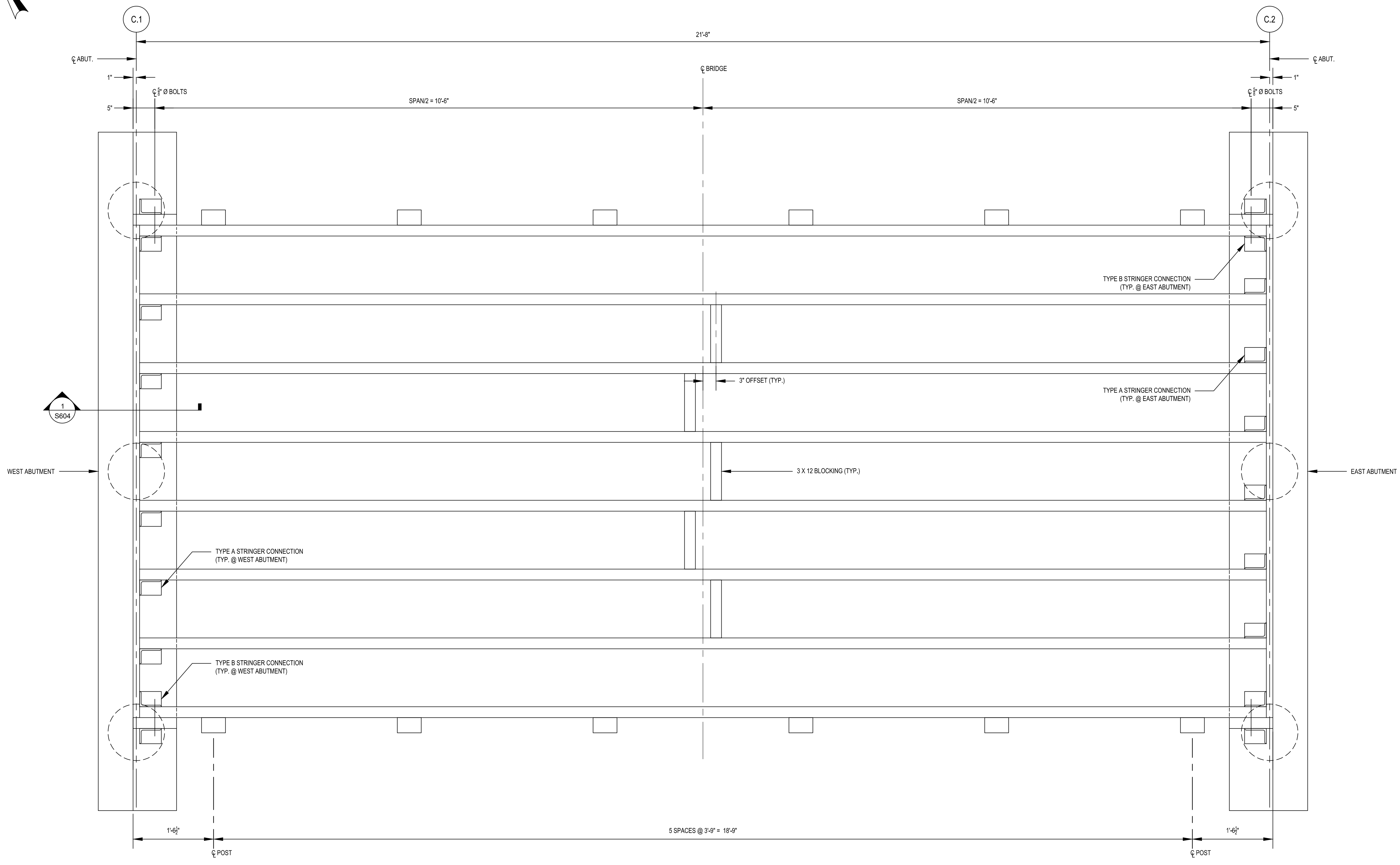
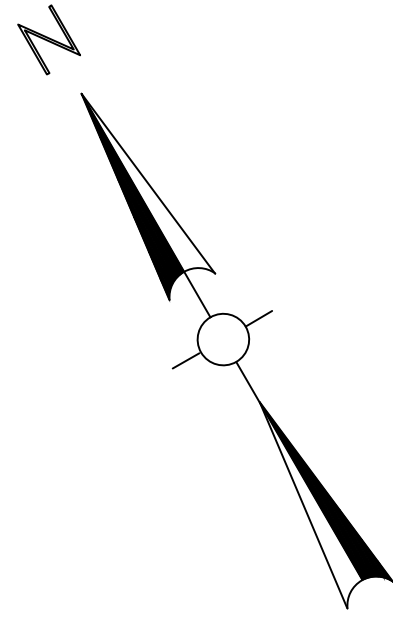

NOTE: RAILING POST ATTACHMENTS ARE NOT SHOWN FOR CLARITY.

**TIMBER BRIDGE FRAMING PLAN**  
SCALE: 1" = 1'-0"

Consultants:

Revisions:

No.	Date	Description

Seal:

Issued For:

**75% DESIGN PLANS**

Scale: AS NOTED  
Date: 03/11/2021  
Drawn By: HLB  
Reviewed By: SYC  
Approved By: SRB

W&S Project No.: ENG20-0145  
W&S File No.:

Drawing Title:  
**TIMBER BRIDGE PLAN & TYP. SECTION**

Sheet Number:  
**S603**

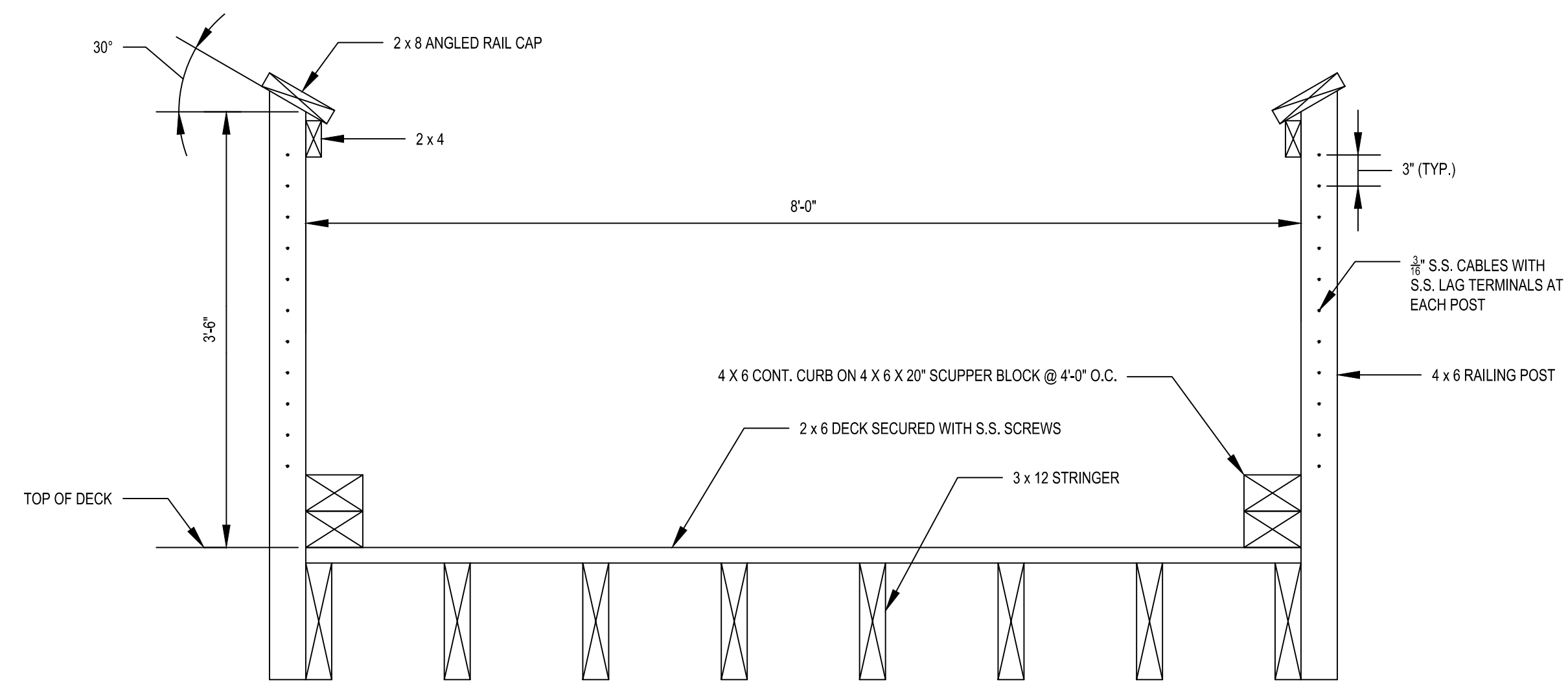

TYP. TIMBER BRIDGE SECTION  
SCALE: 1" = 1'-0"

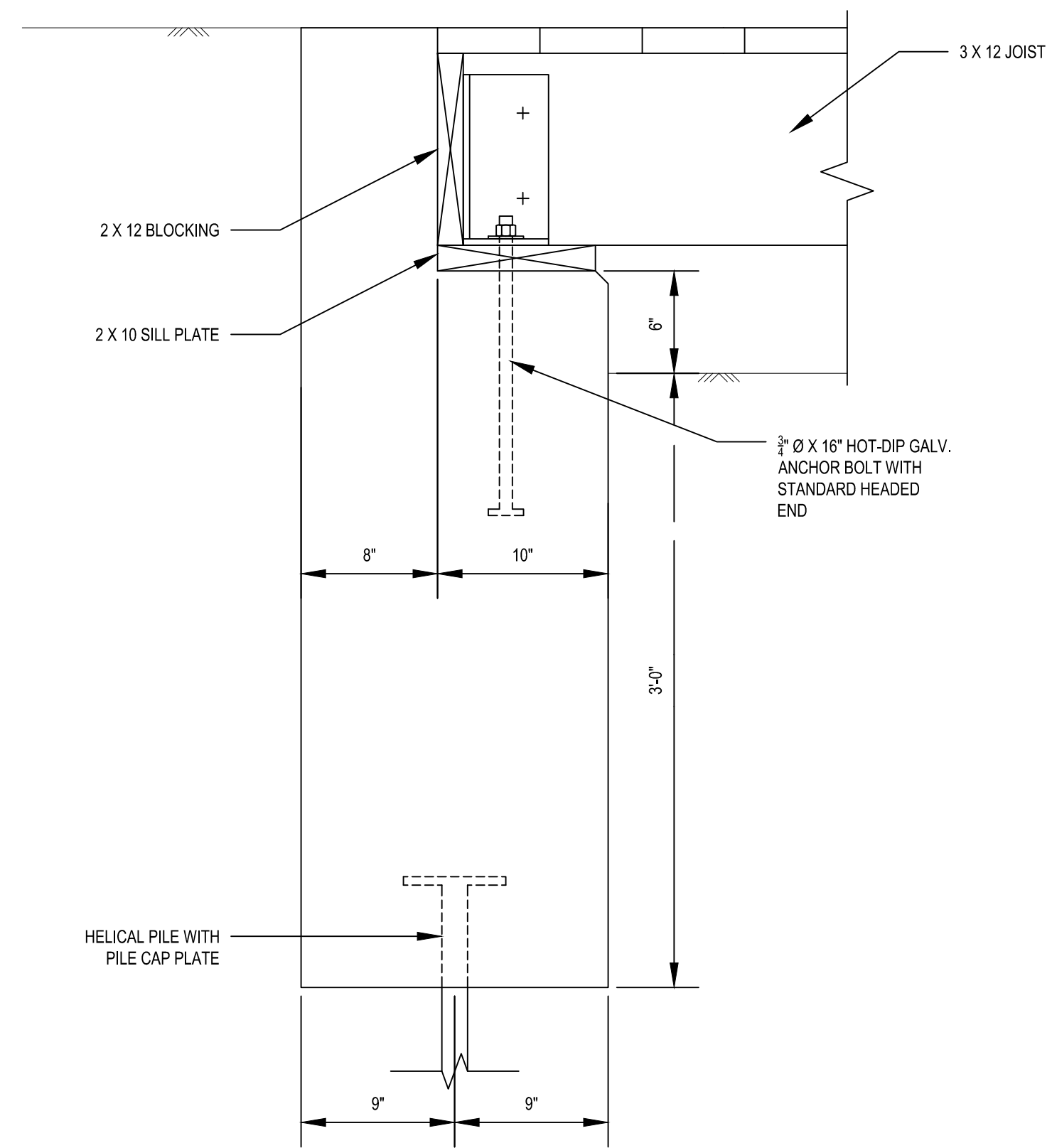

TYP. ABUTMENT SECTION 1  
SCALE: 1 1/2" = 1'-0" S603

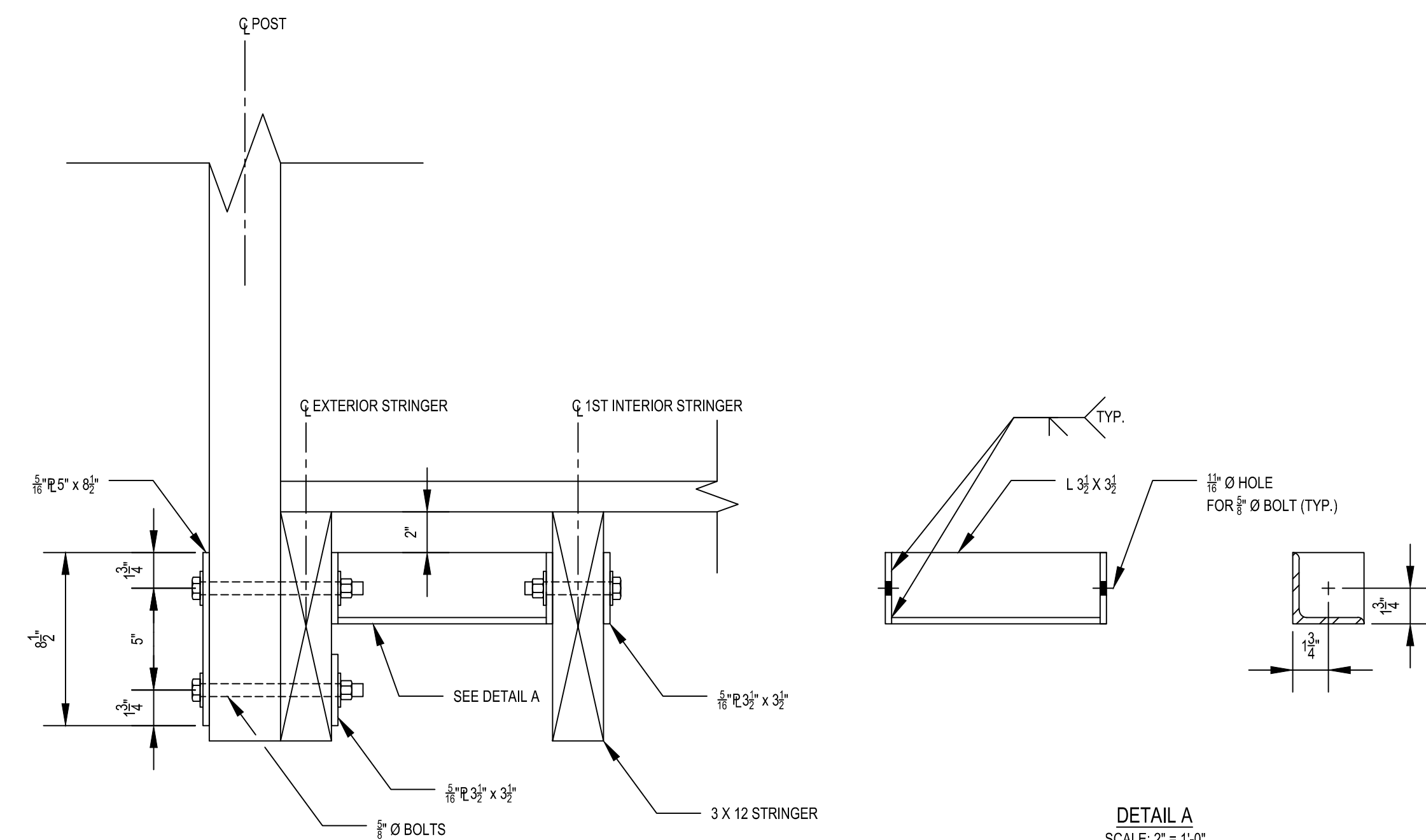

TYP. RAILING POST ATTACHMENT  
SCALE: 2" = 1'-0"

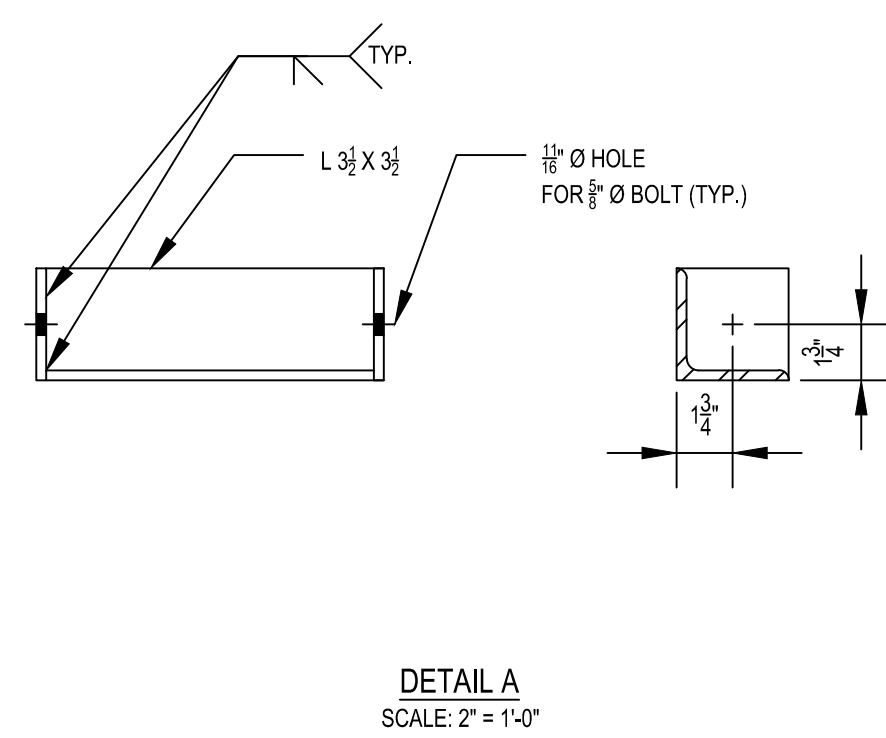

DETAIL A  
SCALE: 2" = 1'-0"

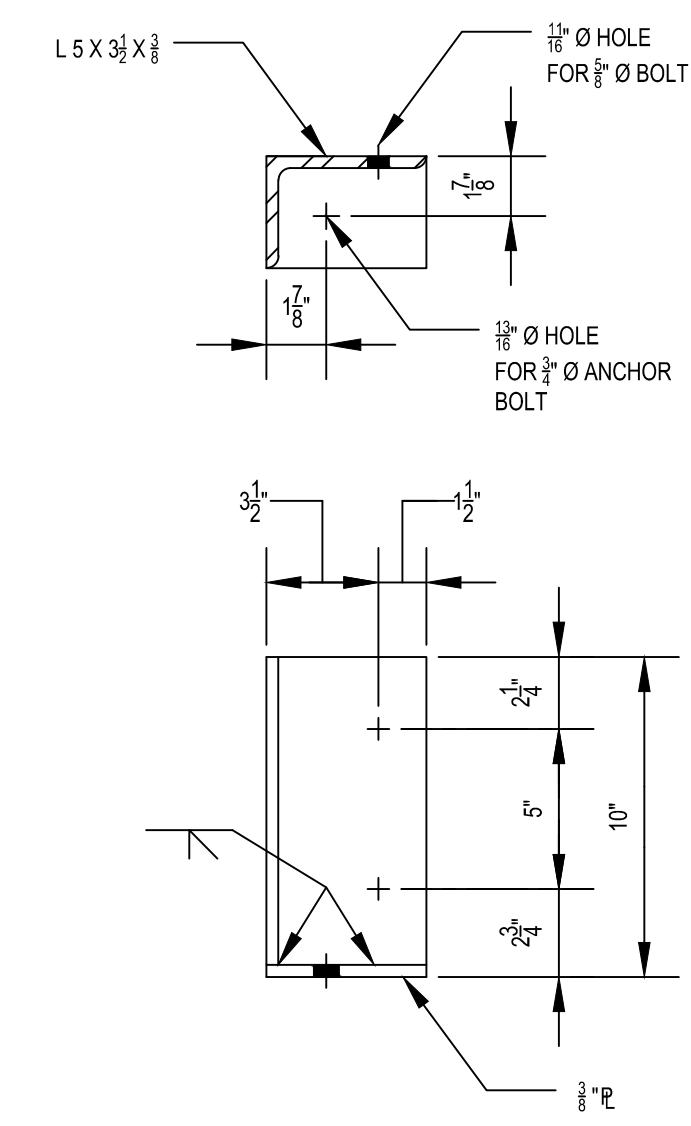

TYP. STRINGER CONNECTION DETAILS  
SCALE: 2" = 1'-0"  
TYPE A (AS SHOWN) TOTAL REQ'D = 16  
TYPE B (SIMILAR) TOTAL REQ'D = 4

Consultants:

Revisions:

No.	Date	Description

Seal:

Issued For:

75% DESIGN PLANS

Scale: AS NOTED  
Date: 03/11/2021  
Drawn By: HLB  
Reviewed By: SYC  
Approved By: SRB  
W&S Project No.: ENG20-0145  
W&S File No.:

Drawing Title:

TIMBER BRIDGE DETAILS

Sheet Number:

S604



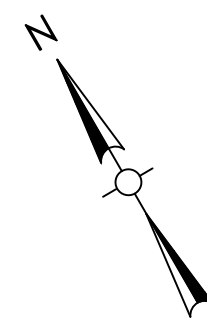

Project:  
**PEABODY RIVERWALK**

RIVERWALK PARK DESIGN PLANS  
 CALLER STREET - HOWLEY STREET  
 PEABODY, MA. 01960

**Weston & Sampson**  
 WESTON & SAMPSON ENGINEERS, INC.  
 85 DEVONSHIRE STREET, 3RD FLOOR  
 BOSTON, MA 02109  
 617-412-4480  
 www.westonandsampson.com

Consultants:

Revisions:

No.	Date	Description

Seal:

Issued For:

**75% DESIGN PLANS**

Scale: AS NOTED  
 Date: 03/11/2021  
 Drawn By: HLB  
 Reviewed By: SYC  
 Approved By: SRB

W&S Project No.: ENG20-0145  
 W&S File No.:

Drawing Title:

**BOARDWALK PLAN & ELEVATION**

Sheet Number:

**S605**

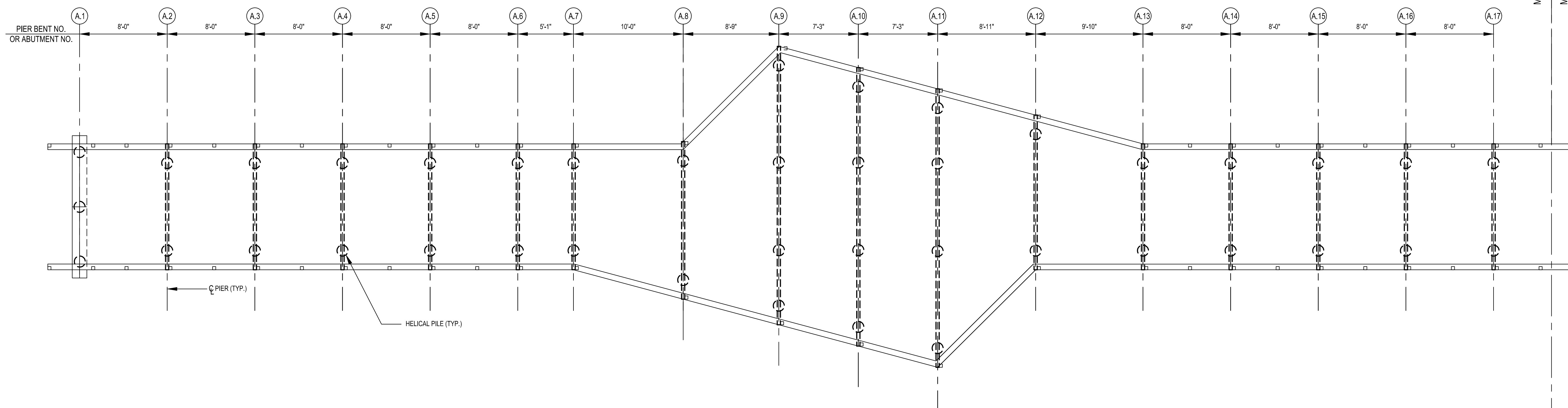

**BOARDWALK PLAN**  
 SCALE: 1" = 5'-0"

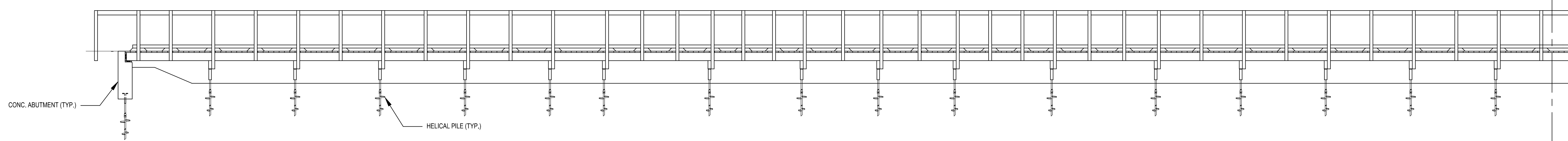

**BOARDWALK ELEVATION**  
 SCALE: 1" = 5'-0"

P:\Projects\2020\0145\ENG\20-0145-01.dwg, 3/11/2021, 10:58:00 AM

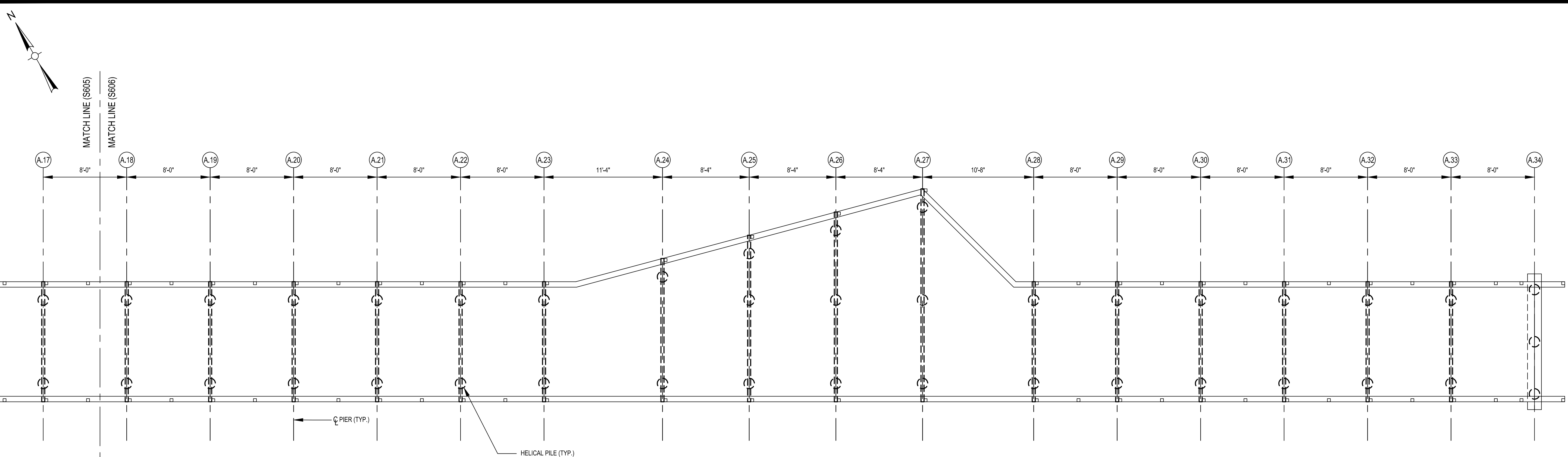

**BOARDWALK PLAN**  
SCALE: 1" = 5'-0"

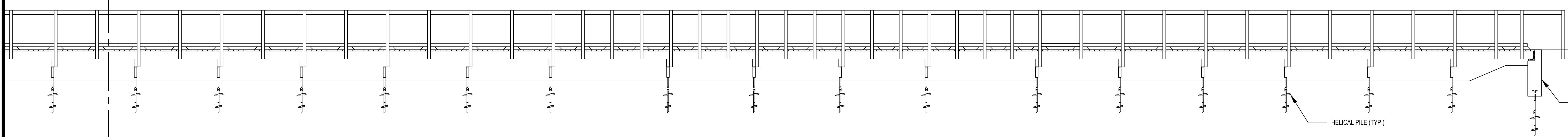

**BOARDWALK ELEVATION**  
SCALE: 1" = 5'-0"

Project:  
PEABODY RIVERWALK

RIVERWALK PARK DESIGN PLANS  
CALLER STREET - HOWLEY STREET  
PEABODY, MA. 01960

**Weston & Sampson**  
WESTON & SAMPSON ENGINEERS, INC.  
85 DEVONSHIRE STREET, 3RD FLOOR  
BOSTON, MA 02109  
617-412-4480  
www.westonandsampson.com

Consultants:

Revisions:

No.	Date	Description

Seal:

Issued For:  
**75% DESIGN PLANS**

Scale: AS NOTED  
Date: 03/11/2021  
Drawn By: HLB  
Reviewed By: SYC  
Approved By: SRB  
W&S Project No.: ENG20-0145  
W&S File No.:

Drawing Title:  
**BOARDWALK PLAN & ELEVATION**

Sheet Number:  
**S606**

P:\Projects\2020\0145\020145-01-01\Drawings\DWG\19032021.dwg





Consultants:

Revisions:

No.	Date	Description

Seal:

Issued For:  
**75% DESIGN PLANS**

Scale: AS NOTED  
 Date: 03/11/2021  
 Drawn By: HLB  
 Reviewed By: SYC  
 Approved By: SRB

W&S Project No.: ENG20-0145  
 W&S File No.:

Drawing Title:  
**BOARDWALK  
 ABUTMENT TYP.  
 SECTIONS**

Sheet Number:  
**S608**

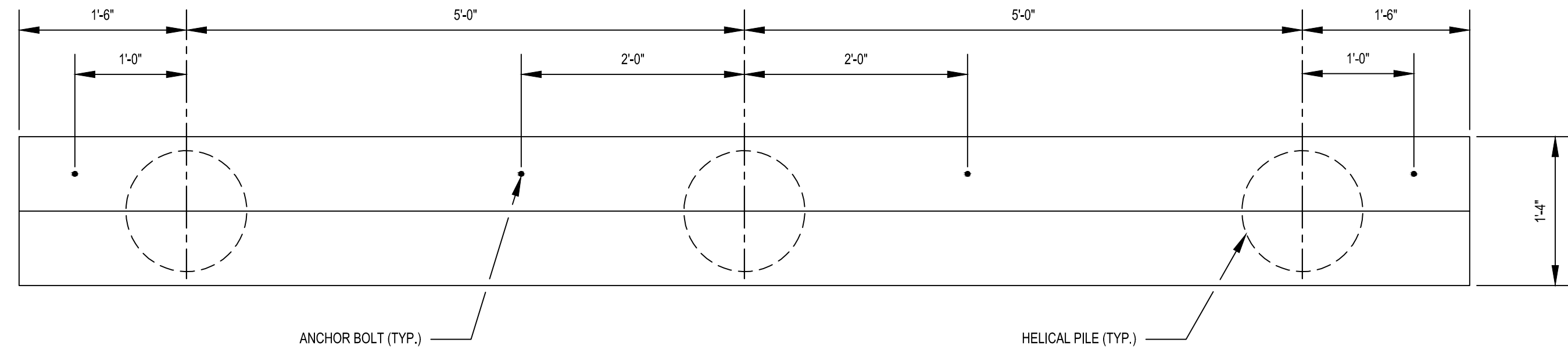

**TYP. ABUTMENT PLAN**  
 SCALE: 1" = 1'-0"

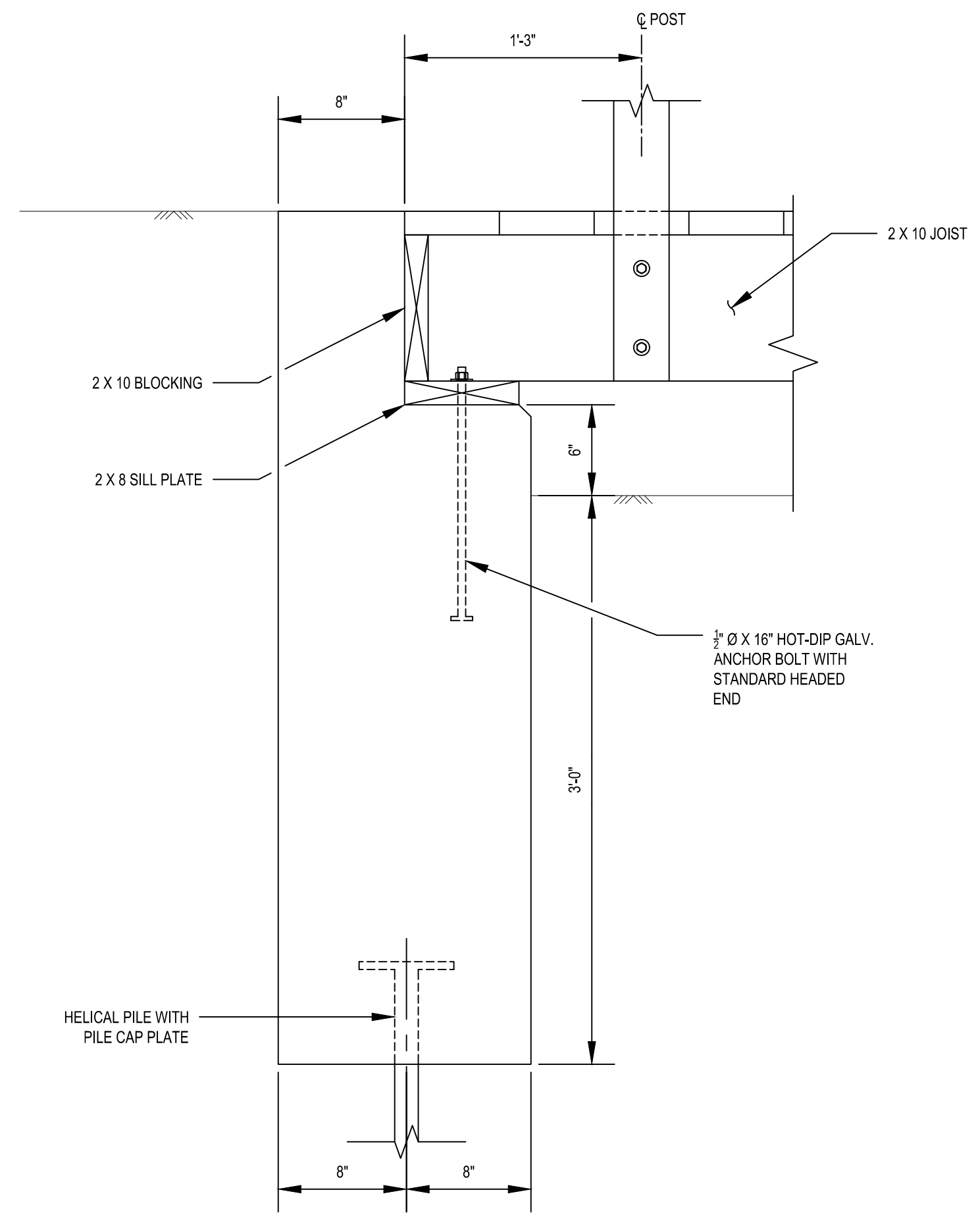

**TYP. ABUTMENT SECTION**  
 SCALE: 1 1/2" = 1'-0"

P:\Projects\2020\2020-0145\2020-0145-01\2020-0145-01.dwg



Consultants:

Revisions:

No.	Date	Description

Seal:

Issued For:

**75% DESIGN PLANS**

Scale: NO SCALE

Date: 03/11/2021

Drawn By: HLB

Reviewed By: SYC

Approved By: SRB

W&S Project No.: ENG20-0145

W&S File No.:

Drawing Title:

**EROSION AND SEDIMENT CONTROL DETAILS**

Sheet Number:

**C601**

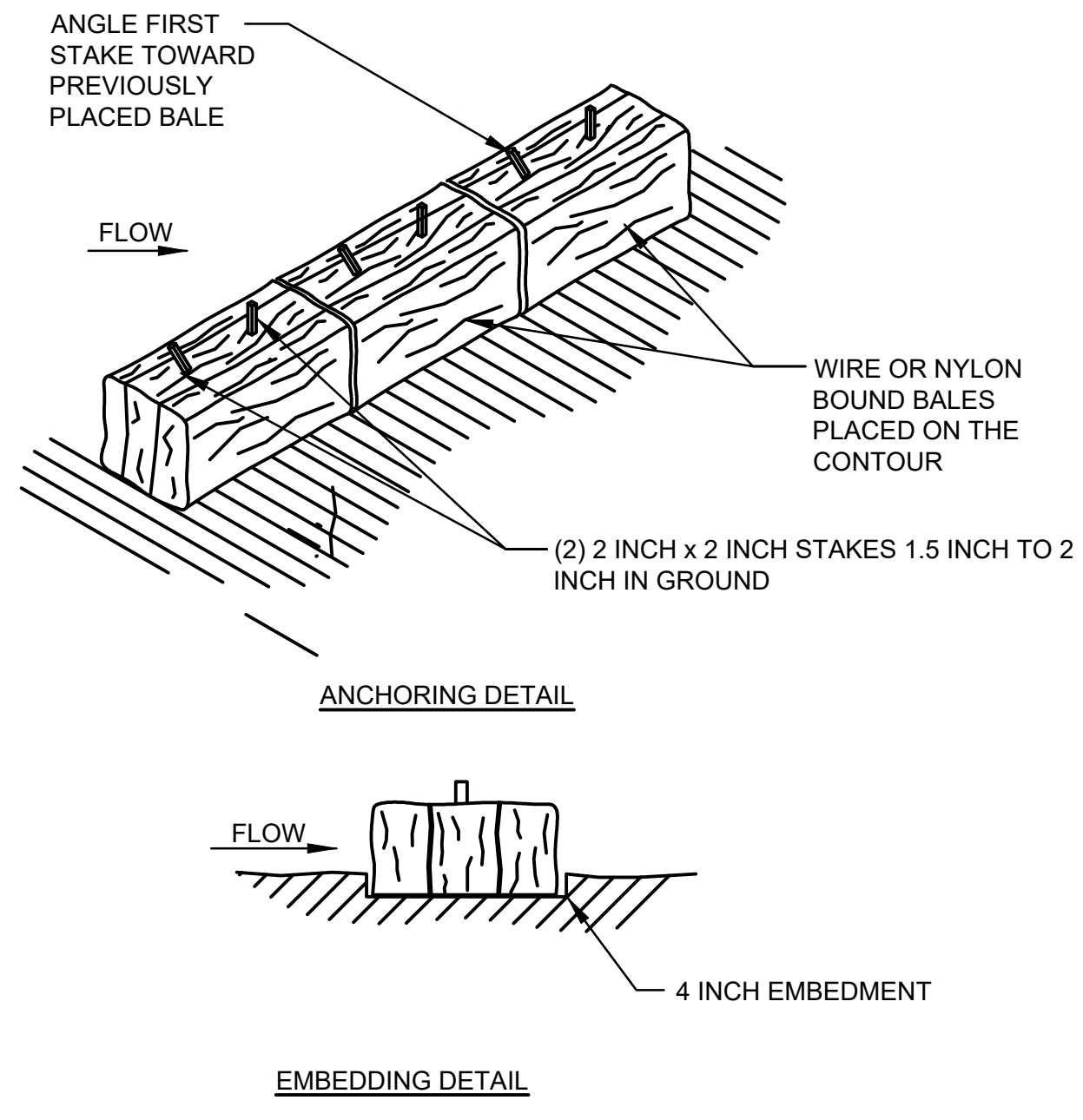

**3 STAKED HALE BALES - EROSION CONTROL**  
SCALE: N.T.S.

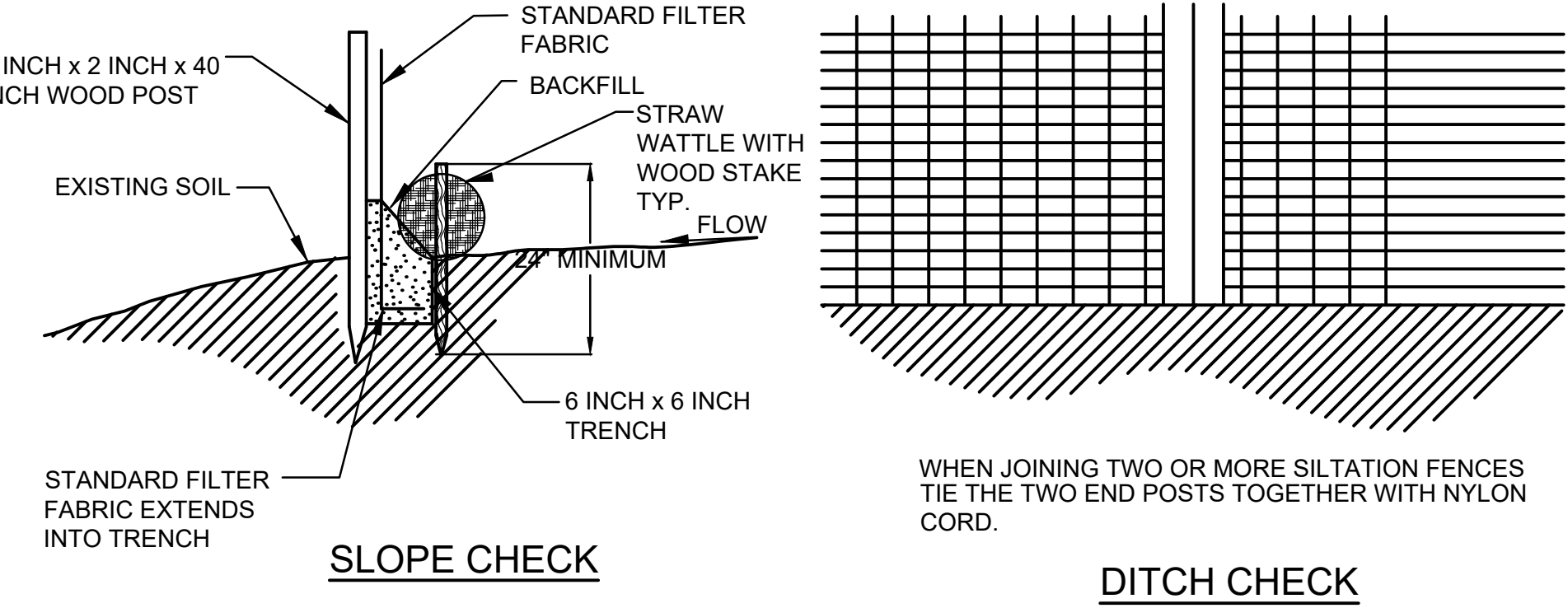

**4 SILT FENCE - EROSION CONTROL**  
SCALE: N.T.S.

**GENERAL NOTES:**

- PROVIDE A MINIMUM TUBE DIAMETER OF 12 INCHES FOR SLOPES UP TO 50 FEET IN LENGTH WITH A SLOPE RATIO OF 3H:1V OR STEEPER. LONGER SLOPES OF 3H:1V MAY REQUIRE LARGER TUBE DIAMETER OR ADDITIONAL COURSING OF FILTER TUBES TO CREATE A FILTER BERM. REFER TO MANUFACTURER'S RECOMMENDATIONS FOR SITUATIONS WITH LONGER OR STEEPER SLOPES.
- INSTALL TUBES ALONG CONTOURS AND PERPENDICULAR TO SHEET OR CONCENTRATED FLOW.
- DO NOT INSTALL IN PERENNIAL, EPHEMERAL OR INTERMITTENT STREAMS.
- CONFIGURE TUBES AROUND EXISTING SITE FEATURES TO MINIMIZE SITE DISTURBANCE AND MAXIMIZE CAPTURE AREA OF STORMWATER RUN-OFF.
- MULCH MATERIAL FOR THE FILTER TUBES SHALL BE WEED-FREE STRAW, WOOD EXCELSIOR, COMPOST, OR WOOD CHIPS, OR COIR. STRAW SHALL BE WEED FREE AND DERIVED FROM THRESHING OF GRAIN CROP.
- CURVE ENDS UPHILL TO PREVENT DIVERSION OF UNFILTERED RUN-OFF.

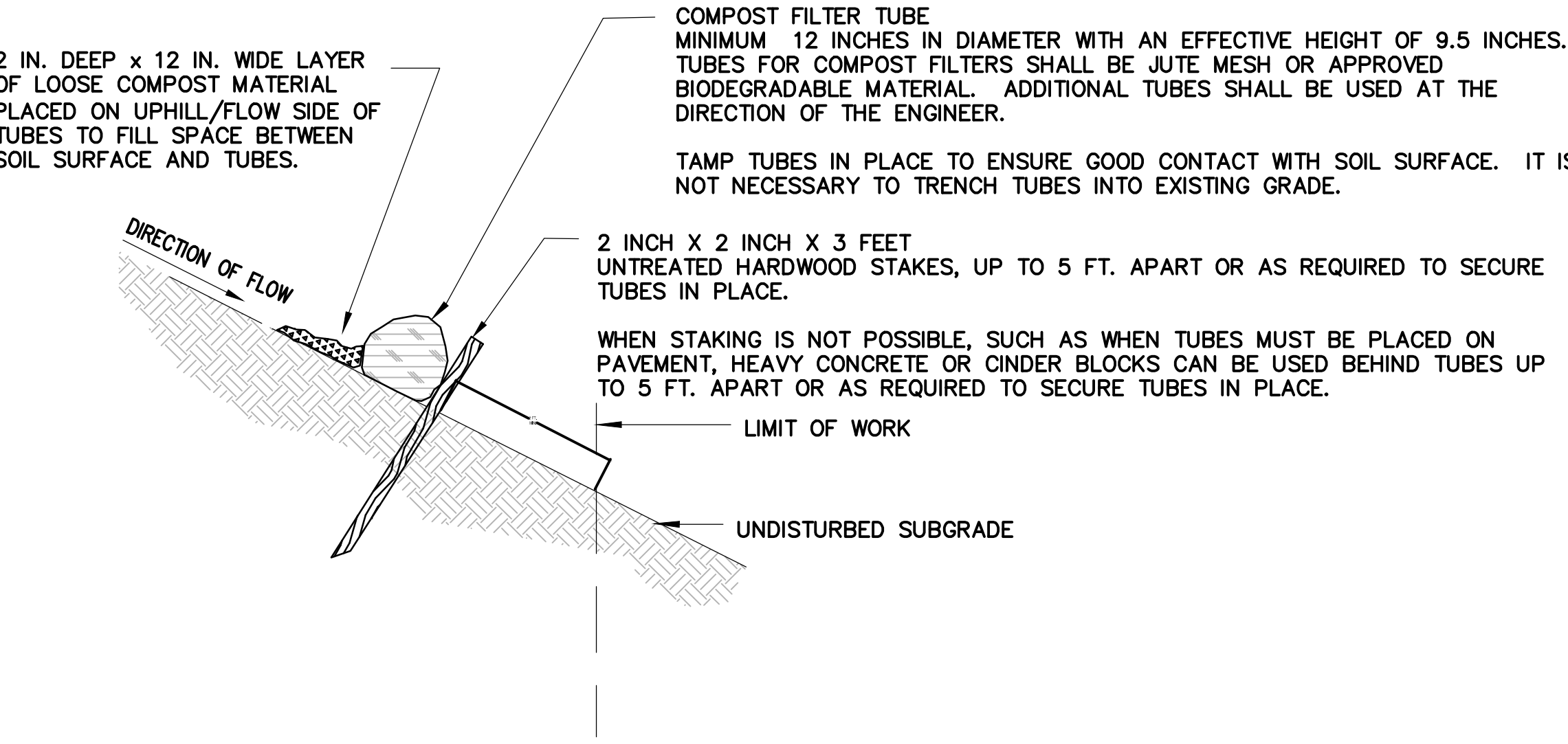

**3 SINGLE COMPOST FILTER TUBE DETAIL**  
SCALE: N.T.S.

- EROSION CONTROL MEASURES SHALL BE INCORPORATED IN THE SEQUENCE OF CONSTRUCTION TO PREVENT SEDIMENT LADEN WATER FROM LEAVING THE SITE.
- AREAS SUBJECT TO EROSION SHALL BE MINIMIZED IN TERMS OF TIME AND AREA.
- IN GENERAL, WORK REQUIRING EROSION CONTROL INCLUDES EXCAVATIONS, FILLS, DRAINAGE, SWALES AND DITCHES, ROUGH AND FINISH GRADING, AND STOCKPILING OF EARTH.
- DO NOT DISTURB VEGETATION AND TOPSOIL BEYOND THE PROPOSED LIMIT OF SILT FENCE ACTIVITIES.
- TEMPORARY SILT CONTROLS SHALL BE PLACED AS SHOWN ON THE PLAN. PERMANENTLY STABILIZE EACH COMPLETED SEGMENT OF CONSTRUCTION.
- THE CONTRACTOR SHALL REMOVE TEMPORARY SILT CONTROLS AND ALL ACCUMULATED SILT AND DEBRIS AFTER COMPLETION OF CONSTRUCTION OPERATIONS.
- SILT CONTROLS SHALL BE IN PLACE AT ALL TIMES DURING CONSTRUCTION.
- THE CONTRACTOR SHALL REMOVE AND LEGALLY DISPOSE OF ALL SILT AND DEBRIS FROM EACH DRAINAGE STRUCTURE UPON COMPLETION OF THE PROJECT.
- OBJECTS AND/OR AREAS DAMAGED BY THE CONTRACTOR'S OPERATIONS SHALL BE RESTORED TO THEIR ORIGINAL CONDITION.
- ALL DISTURBED AREAS SHALL BE RESTORED TO EXISTING GRADE. INSPECTION SHALL BE FREQUENT AND REPAIR OR REPLACEMENT SHALL BE MADE AS NEEDED.
- SILT CONTROLS SHALL BE REMOVED UPON THE SATISFACTORY COMPLETION OF ALL WORK SO AS NOT TO BLOCK OR IMPEDE STORM FLOW OR DRAINAGE.
- SITE PERIMETER SHALL HAVE STRAW WATTLES INSTALLED AT THE LIMIT OF WORK.

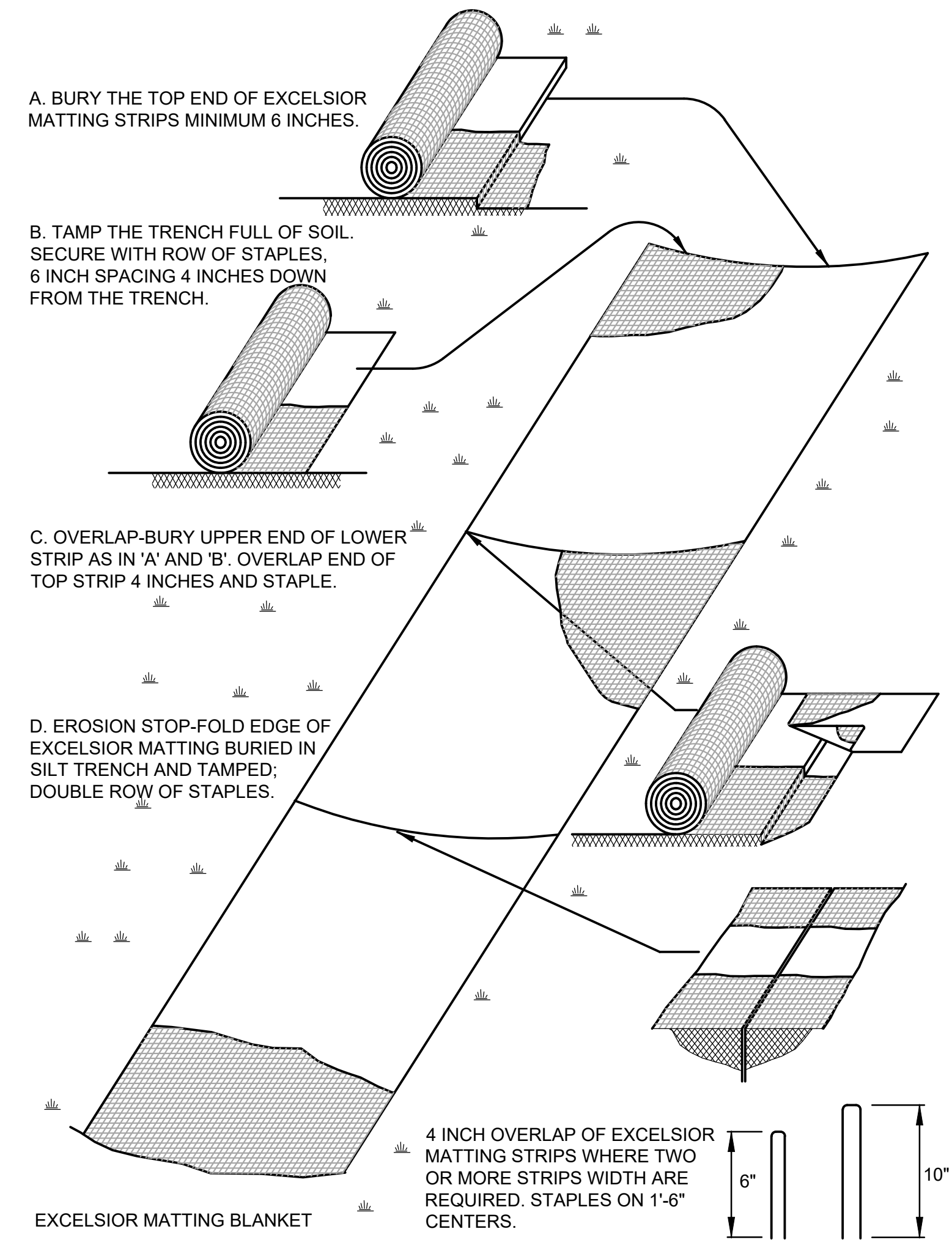

**4 EROSION CONTROL BLANKET**  
SCALE: N.T.S.

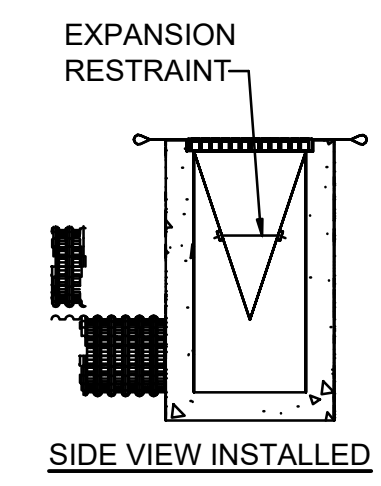

**1 INLET SEDIMENT CONTROL**  
SCALE: N.T.S.

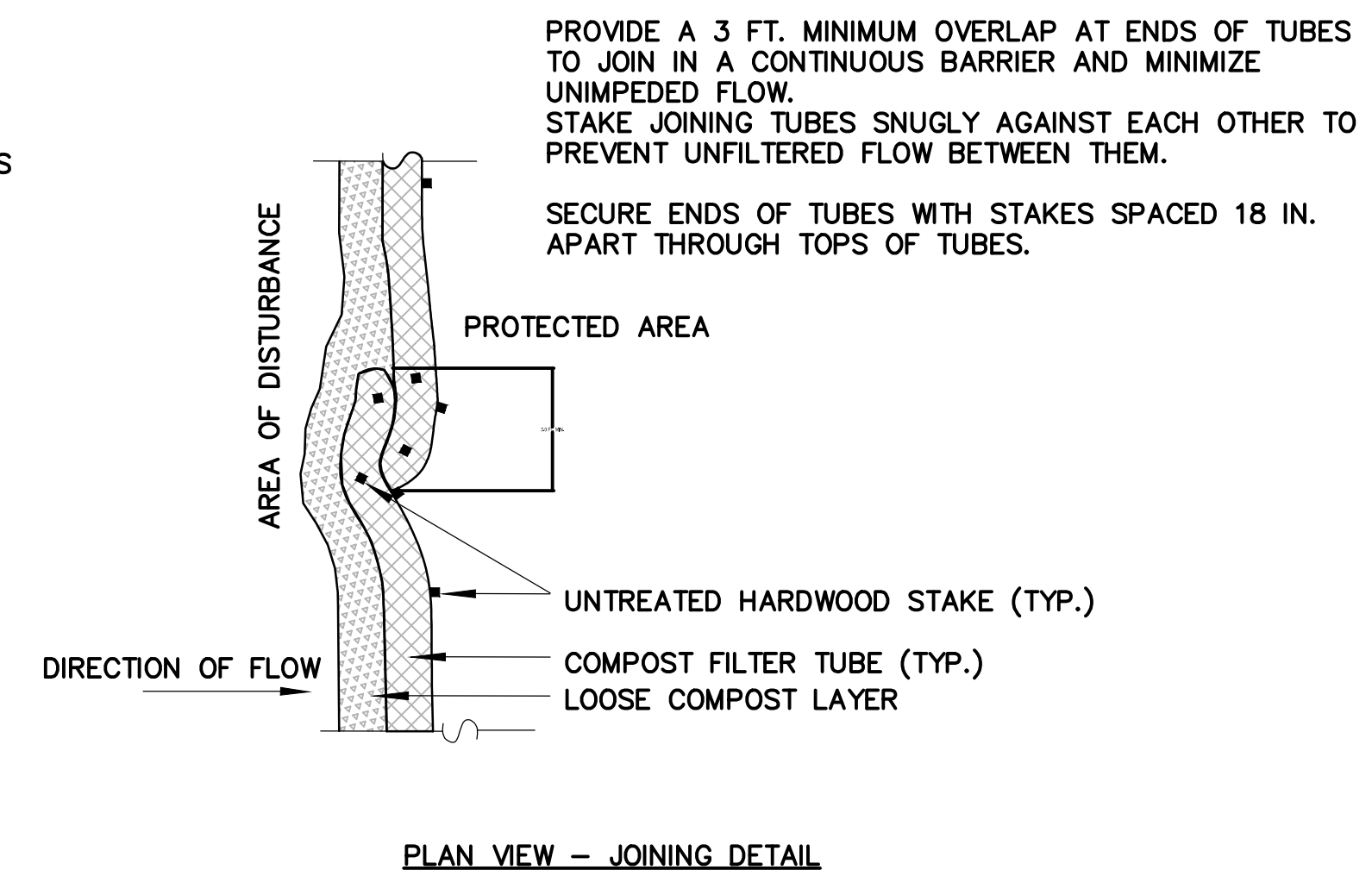

**PLAN VIEW - JOINING DETAIL**







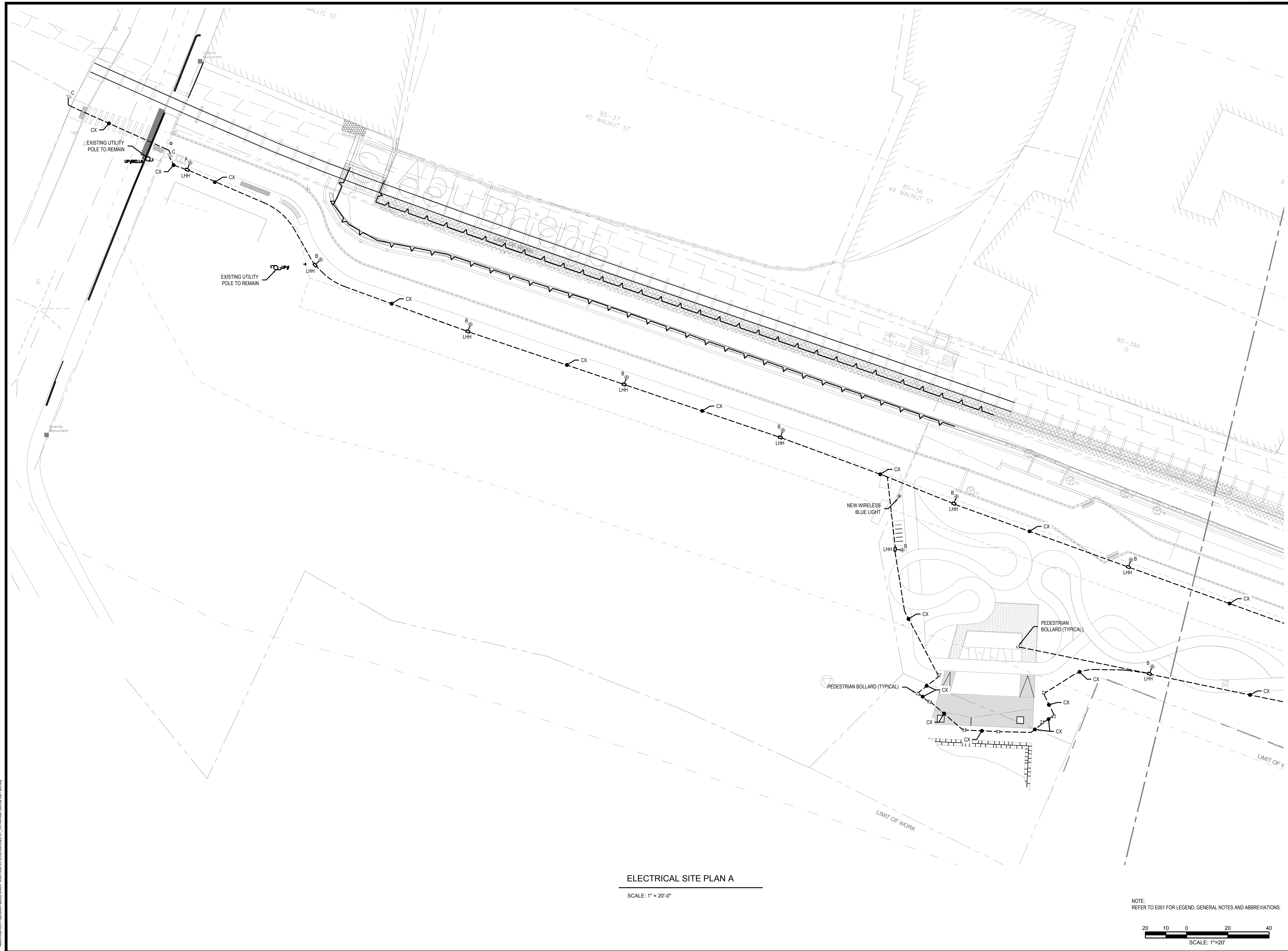

ELECTRICAL SITE PLAN A

SCALE: 1" = 20'-0"

NOTE:  
REFER TO E001 FOR LEGEND, GENERAL NOTES AND ABBREVIATIONS.

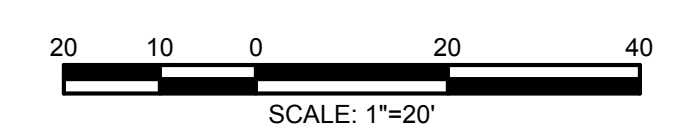

Project:  
PEABODY RIVERWALK  
RIVERWALK PARK

WALLIS STREET -  
CALLER STREET -  
HOWLEY STREET  
PEABODY, MA. 01960

**Weston & Sampson**  
WESTON & SAMPSON ENGINEERS, INC.  
85 DEVONSHIRE STREET, 3RD FLOOR  
BOSTON, MA 02109  
617-412-4480  
www.westonandsampson.com

Consultants:

Revisions:

No.	Date	Description

Seal:

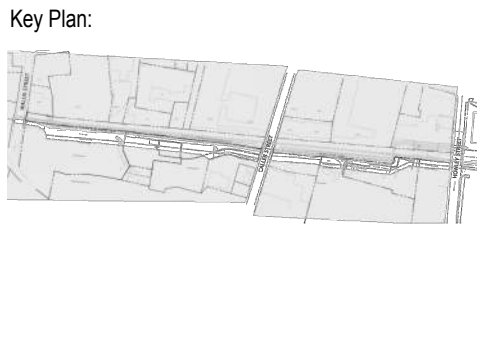

Issued For:  
**75% DESIGN DEVELOPMENT  
- NOT FOR CONSTRUCTION -**

Scale: AS NOTED  
Date: MARCH 2021  
Drawn By: FN  
Reviewed By: DNM  
Approved By: RFM

W&S Project No.: ENG20-0145  
W&S File No.:

Drawing Title:  
**ELECTRICAL  
SITE PLAN A**

Sheet Number:  
**E101**



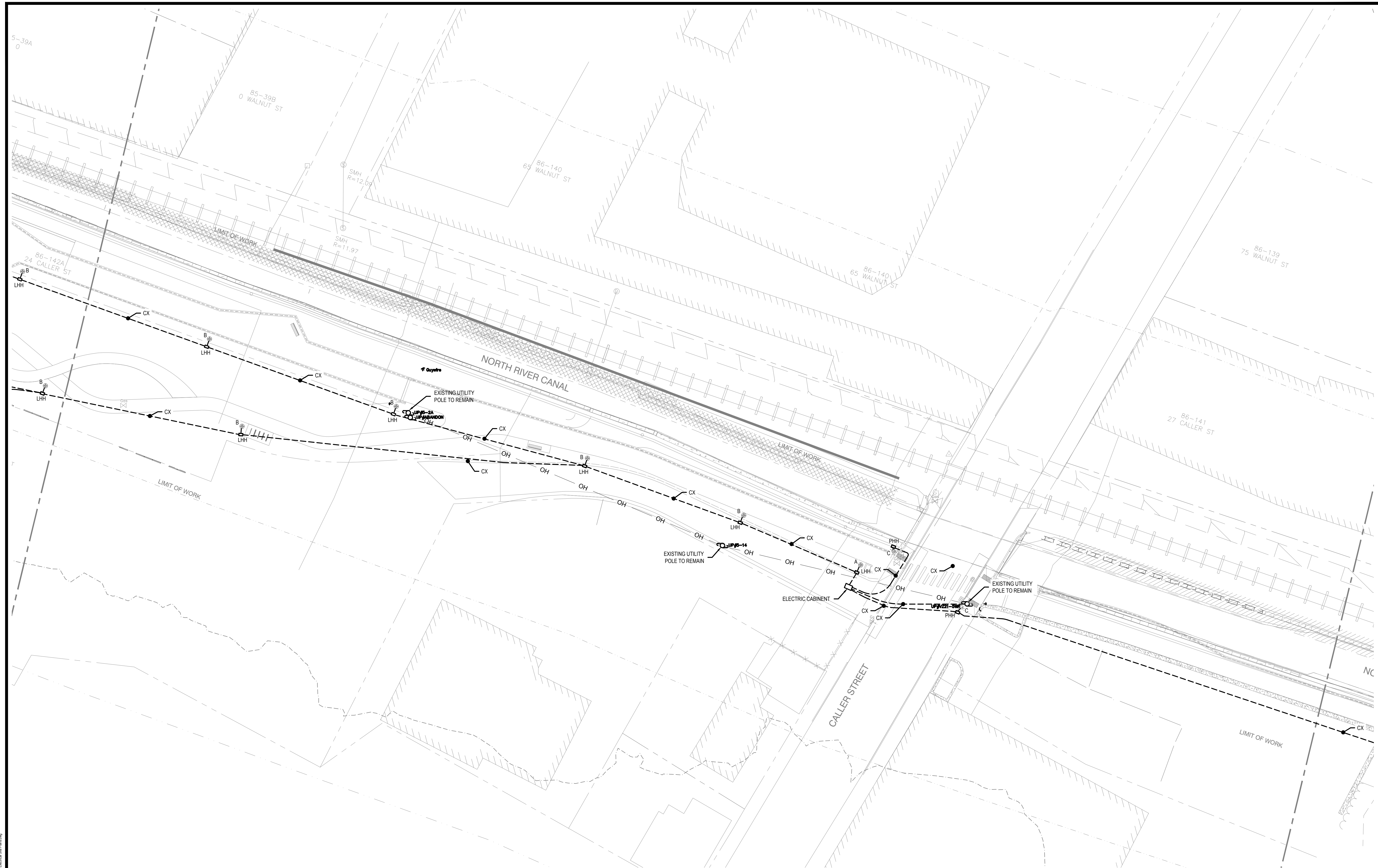

**ELECTRICAL SITE PLAN B**

SCALE: 1" = 20'-0"

NOTE:  
REFER TO E001 FOR LEGEND, GENERAL NOTES AND ABBREVIATIONS.

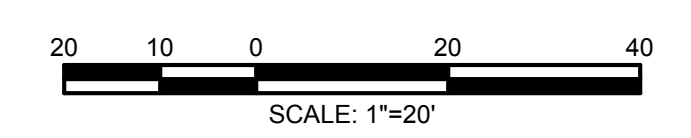

Project:  
PEABODY RIVERWALK  
RIVERWALK PARK

WALLIS STREET -  
CALLER STREET -  
HOWLEY STREET  
PEABODY, MA. 01960

**Weston & Sampson**  
WESTON & SAMPSON ENGINEERS, INC.  
85 DEVONSHIRE STREET, 3RD FLOOR  
BOSTON, MA 02109  
617.412.4480  
www.westonandsampson.com

Consultants:

--

Revisions:

No.	Date	Description

Seal:

Key Plan:

Issued For:  
**75% DESIGN DEVELOPMENT  
- NOT FOR CONSTRUCTION -**

Scale:	AS NOTED
Date:	MARCH 2021
Drawn By:	FN
Reviewed By:	DNM
Approved By:	RFM

W&S Project No.: ENG20-0145  
W&S File No.:

Drawing Title:  
**ELECTRICAL  
SITE PLAN B**

Sheet Number:  
**E102**







Consultants:

--	--	--

Revisions:

No.	Date	Description

Seal:

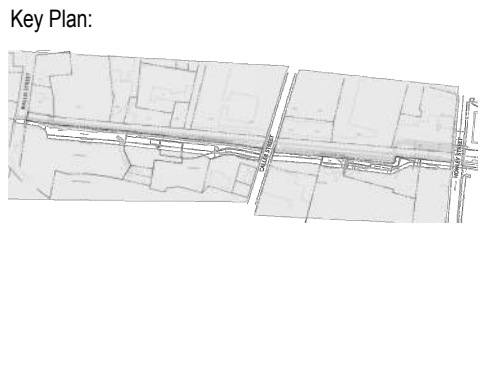

Issued For:  
**75% DESIGN DEVELOPMENT - NOT FOR CONSTRUCTION -**

Scale: NO SCALE  
 Date: MARCH 2021  
 Drawn By: FN  
 Reviewed By: DNM  
 Approved By: RFM  
 W&S Project No.: ENG20-0145  
 W&S File No.:

Drawing Title:  
**ELECTRICAL DETAILS**  
 Sheet Number:  
**E501**

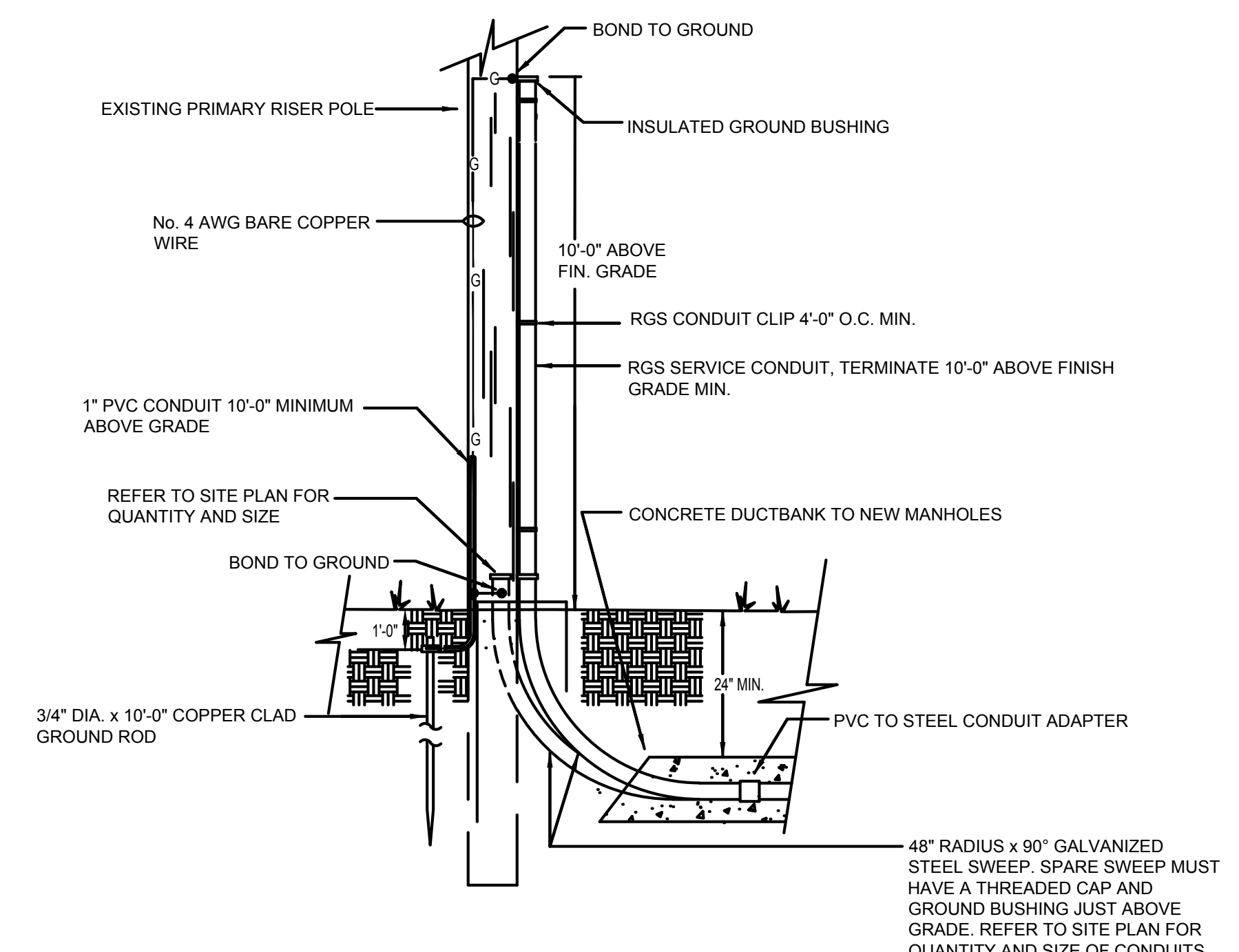

**TYPICAL RISER POLE DETAIL**  
 NOT TO SCALE

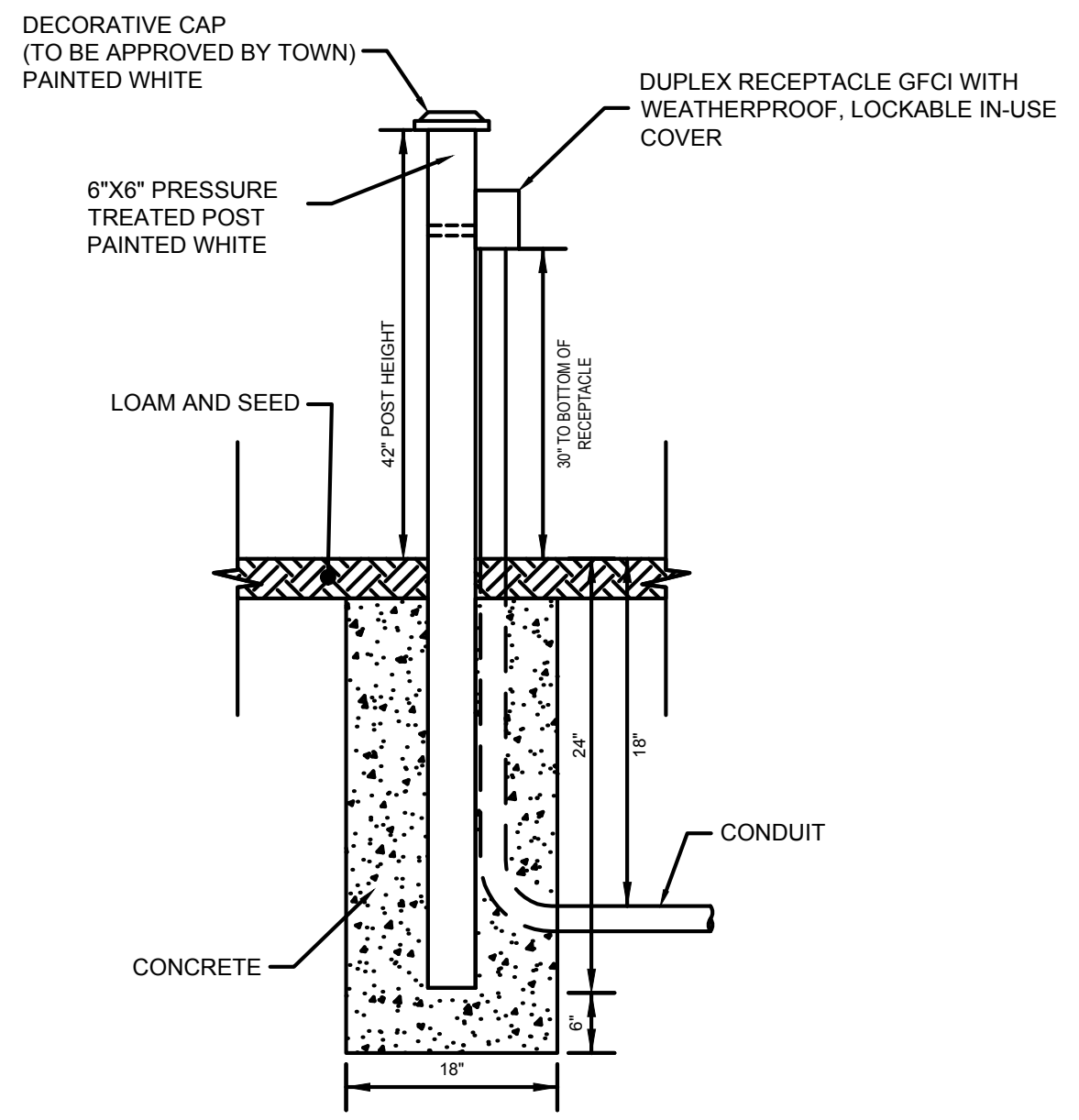

**POST AND RECEPTACLE DETAIL**  
 NOT TO SCALE

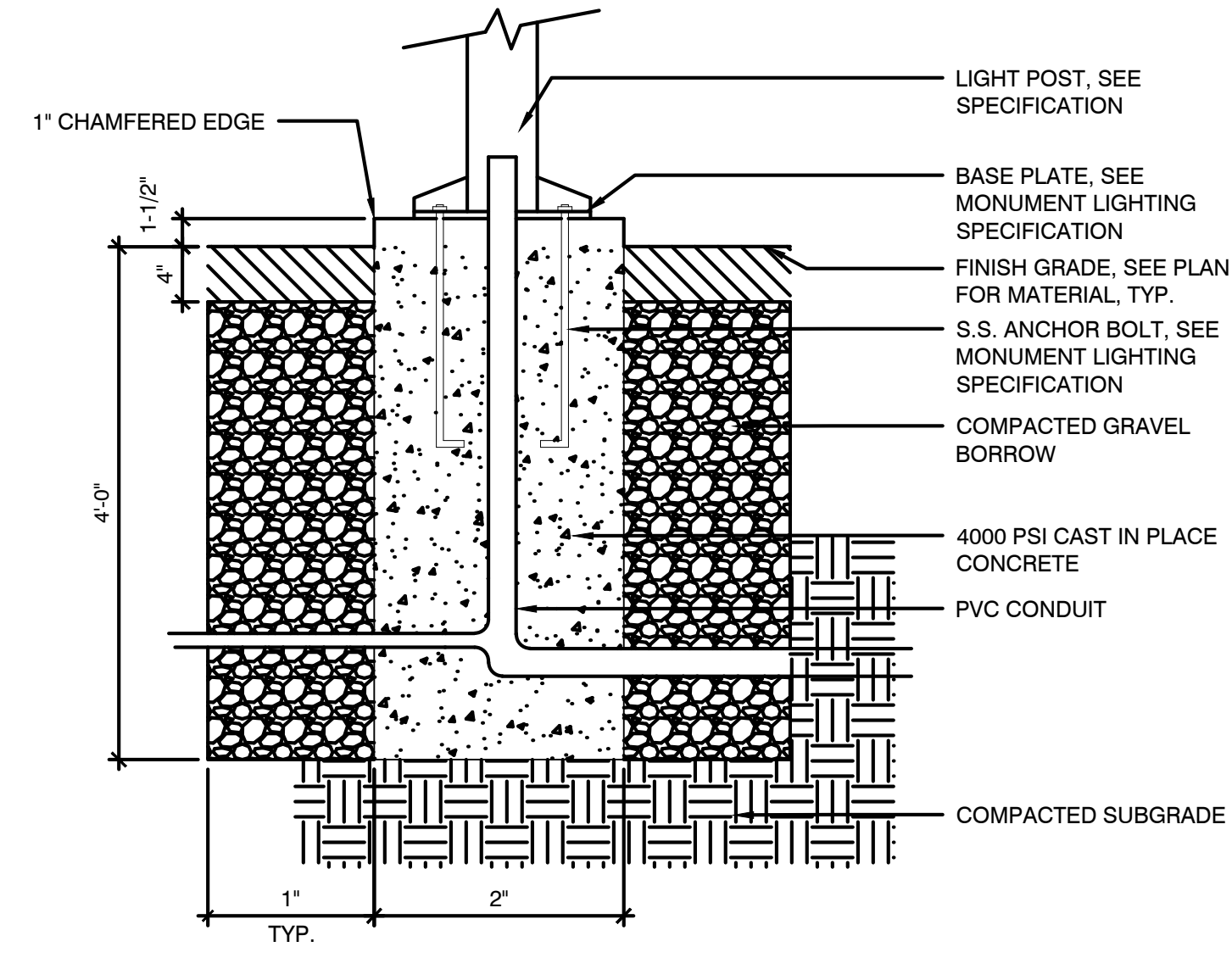

**LIGHT POST FOOTING (TYPICAL)**  
 NOT TO SCALE

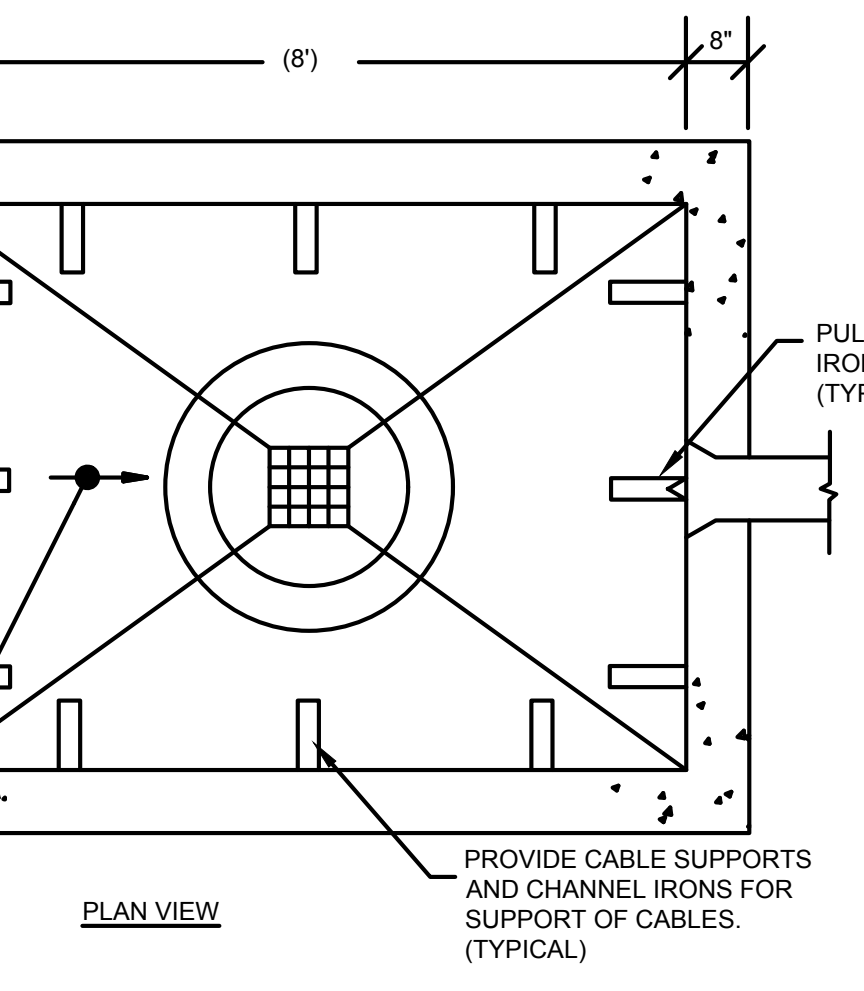
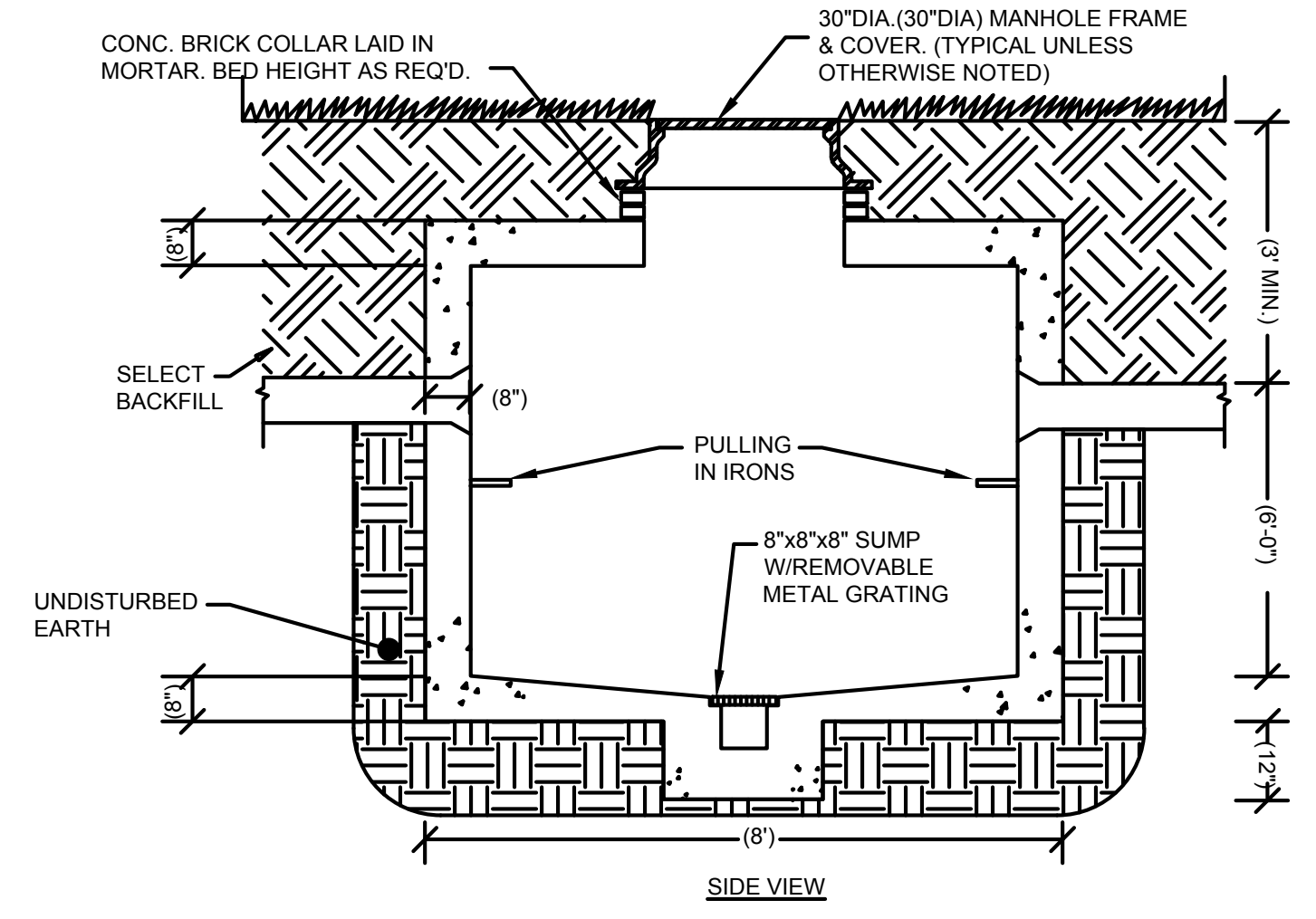

**TYPICAL MANHOLE DETAIL**  
 NOT TO SCALE

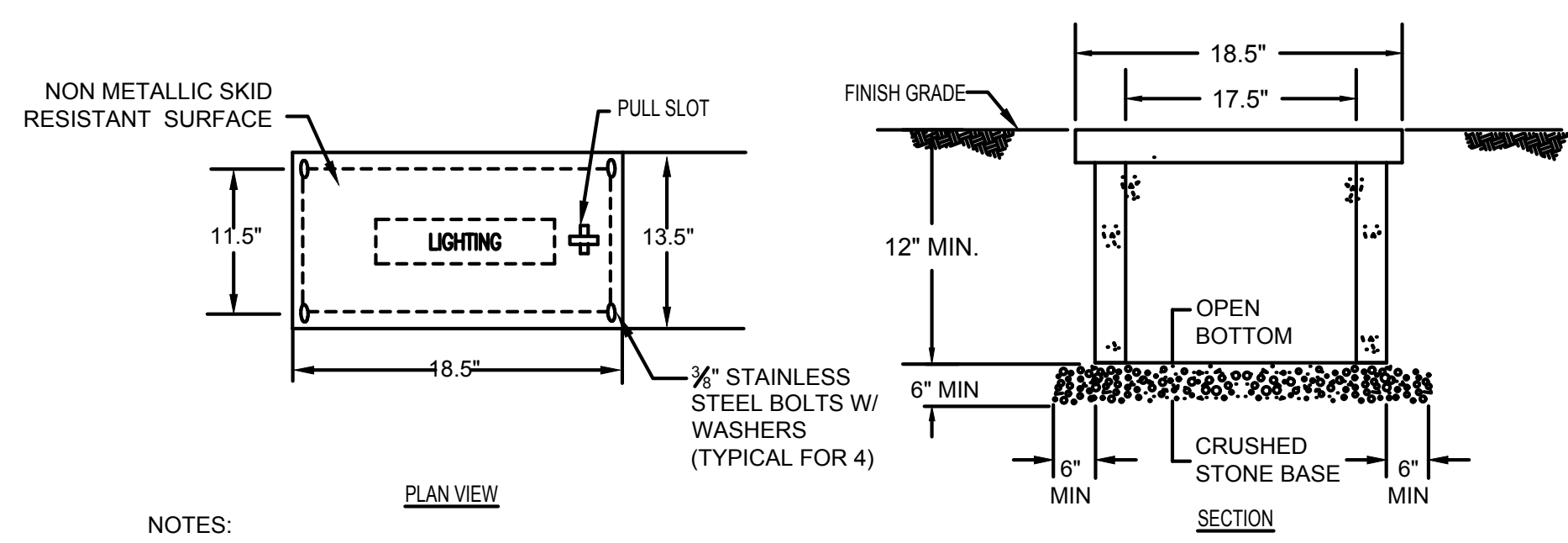

- NOTES:
1. THIS HANDHOLE IS INTENDED FOR NON-DELIBERATE VEHICULAR TRAFFIC ONLY.
  2. HANDHOLE SHALL BE PREFABRICATED POLYMER CONCRETE AGGREGATE EQUAL TO QUAZITE OR EQUAL PRE CAST CONCRETE CONSTRUCTION.

**PREFABRICATED HANDHOLE DETAIL (TYPICAL)**  
 NOT TO SCALE

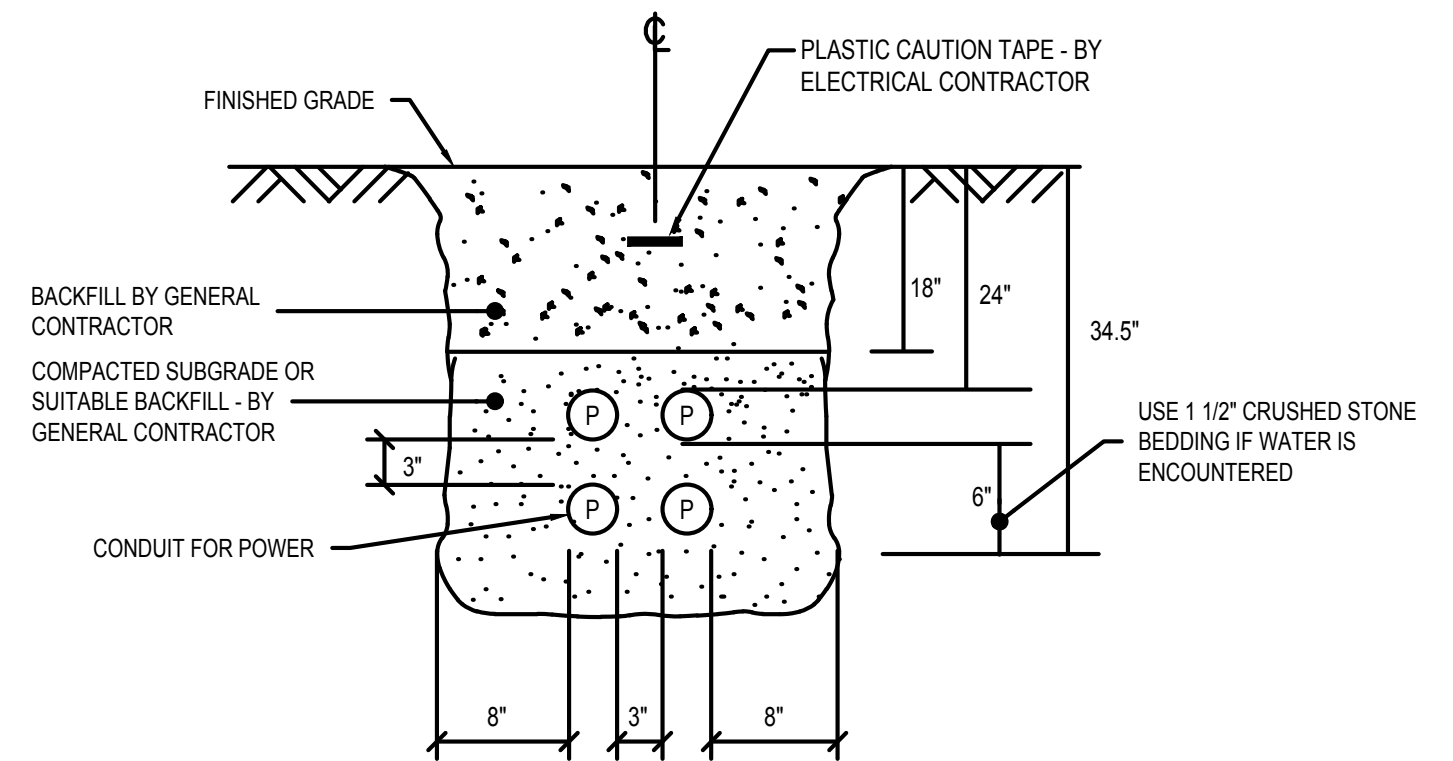

**TYPICAL DIRECT BURIED MULTIPLE CONDUIT DETAIL**  
 NOT TO SCALE

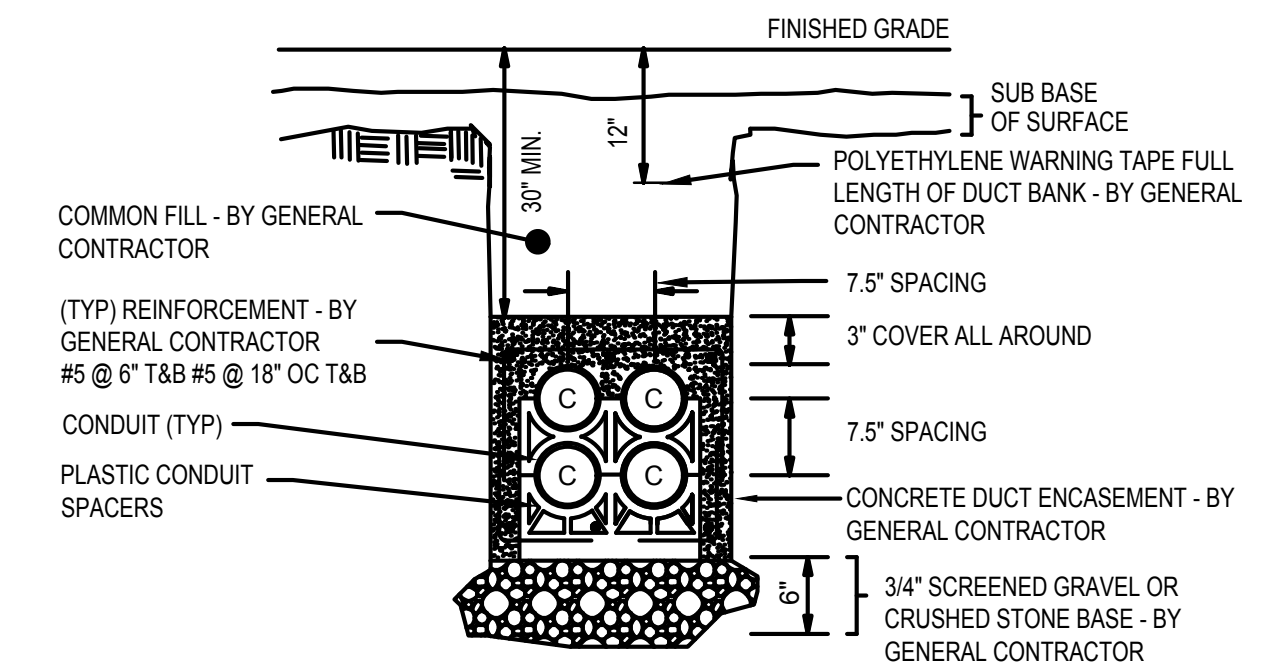

**TYPICAL CONCRETE ENCASED DUCTBANK DETAIL**  
 NOT TO SCALE

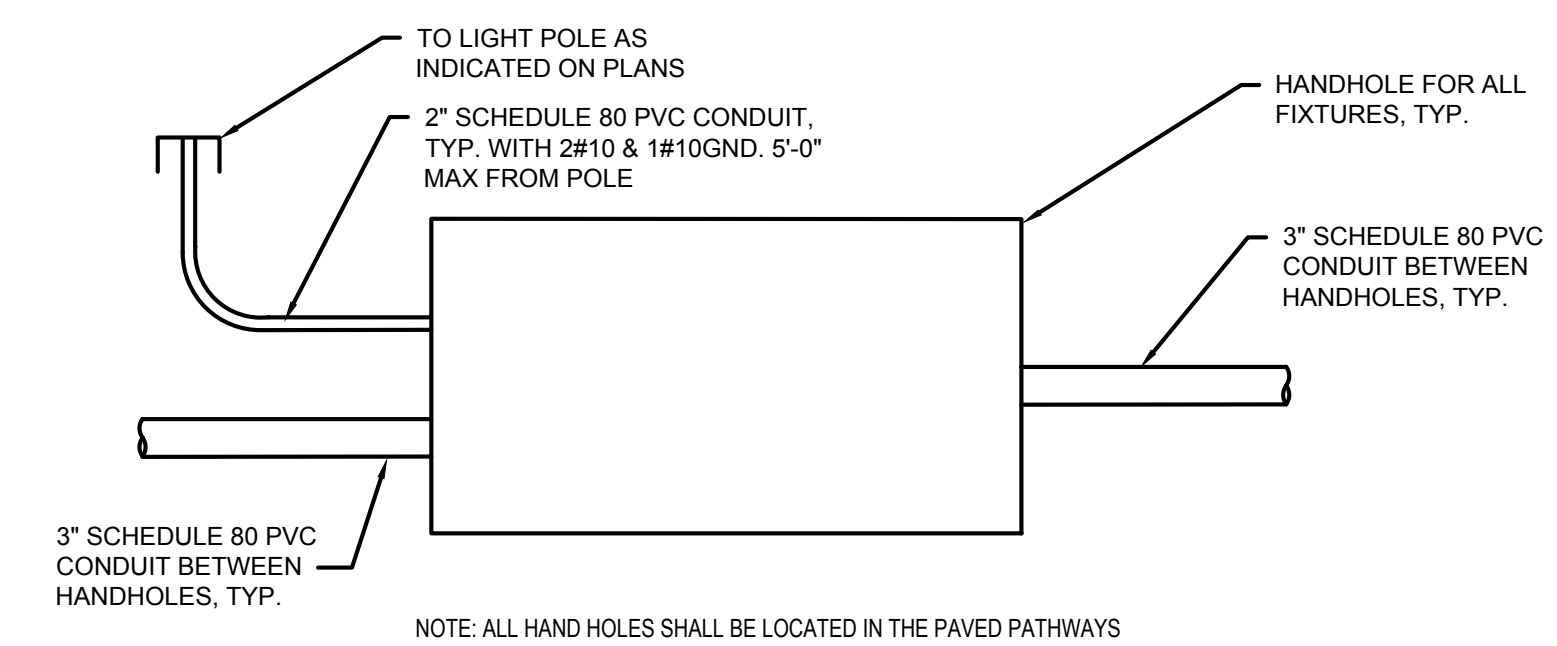

**PEDESTRIAN SITE LIGHTING DISTRIBUTION DETAIL (TYPICAL)**  
 NOT TO SCALE

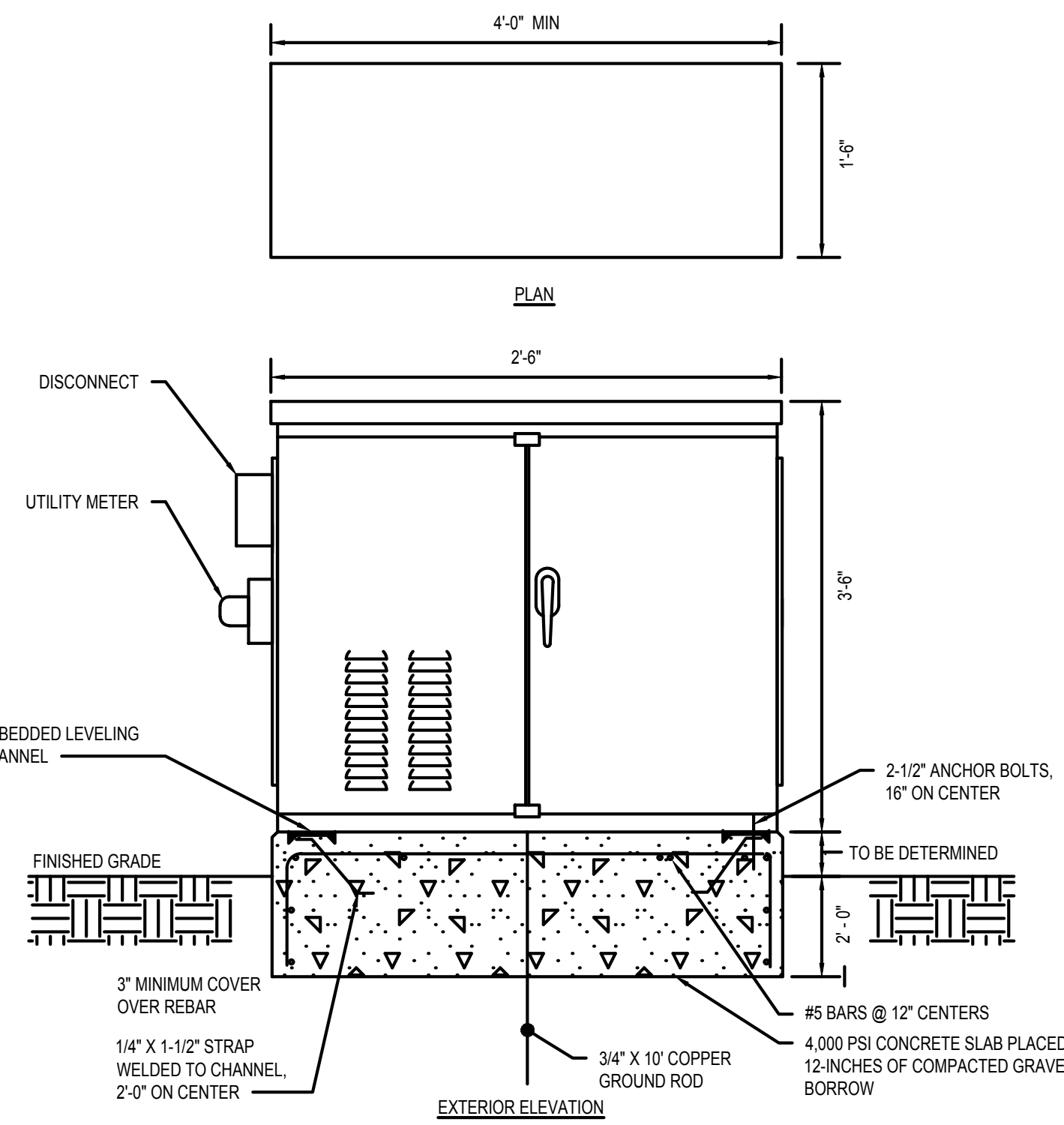

- NOTES:
1. CONTRACTOR SHALL COORDINATE WITH THE EXACT CABINET SIZE WITH ALL MANUFACTURER EQUIPMENT SIZES PRIOR TO SUBMITTING THE CABINET FOR APPROVAL. PROVIDE A SCALED DRAWING SHOWING ALL EQUIPMENT.

**PAD MOUNTED 2-DOOR NEMA 3R ELECTRICAL CABINET DETAIL**  
 NOT TO SCALE







## Notice of Intent



July 2021

PEABODY – MVP RIVERWALK

PREPARED FOR:  
CITY OF PEABODY

SUBMITTED TO:  
PEABODY CONSERVATION COMMISSION





July XX 2021

Peabody Conservation Commission  
24 Lowell Street  
Peabody, Massachusetts 01960

**Re:     NOI Filing**  
          **MVP Riverwalk Project**

Dear Members of the Commission:

On behalf of the City of Peabody, Weston & Sampson Engineers, Inc. is hereby enclosing two (2) copies (including original) of the Notice of Intent submittal (including plans) to fulfill the requirements of the Massachusetts Wetlands Protection Act, M.G.L. Chapter 131, Section 40 submittal requirements and the City of Peabody submittal requirements. This submittal is a formal Notice of Intent for the new Riverwalk in the vicinity of Proctor Brook.

As part of the filing, we have attached the following:

Appendix A:     Project Description  
Appendix B:     Alternatives Analysis  
Appendix C:     Project Maps  
Appendix D:     Applicable Technical Specifications  
Appendix E:     Wetlands Memorandum  
Appendix F:     Photographs  
Appendix G:     Stormwater Report  
Appendix H:     Abutter Information

If you have any questions regarding this submittal, please contact me at (978) 532-1900.

Sincerely,



WESTON & SAMPSON ENGINEERS, INC  
Alexandra Gaspar  
Environmental Scientist



Enter your transmittal number

X287572

Transmittal Number

Your unique Transmittal Number can be accessed online:

<http://www.mass.gov/eea/agencies/massdep/service/approvals/transmittal-form-for-payment.html>

Massachusetts Department of Environmental Protection

## Transmittal Form for Permit Application and Payment

1. Please type or print. A separate Transmittal Form must be completed for each permit application.

2. Make your check payable to the Commonwealth of Massachusetts and mail it with a copy of this form to: MassDEP, P.O. Box 4062, Boston, MA 02211.

3. Three copies of this form will be needed.

**Copy 1 - the original** must accompany your permit application. **Copy 2** must accompany your fee payment. **Copy 3** should be retained for your records

4. Both fee-paying and exempt applicants must mail a copy of this transmittal form to:

MassDEP  
P.O. Box 4062  
Boston, MA  
02211

\* **Note:**  
For BWSC Permits, enter the LSP.

### A. Permit Information

WPA Form 3

wetlands

1. Permit Code: 4 to 7 character code from permit instructions

2. Name of Permit Category

riverwalk

3. Type of Project or Activity

### B. Applicant Information – Firm or Individual

City of Peabody

1. Name of Firm - Or, if party needing this approval is an individual enter name below:

2. Last Name of Individual

3. First Name of Individual

4. MI

24 Lowell Street

5. Street Address

Peabody

MA

01960

978-538-5780

6. City/Town

7. State

8. Zip Code

9. Telephone #

10. Ext. #

Brendan Callahan, Asst. Director of Planning

brendan.callahan@peabody-ma.gov

11. Contact Person

12. e-mail address

### C. Facility, Site or Individual Requiring Approval

1. Name of Facility, Site Or Individual

approximately between Wallis Street to Howley Street

2. Street Address

Peabody

MA

01960

3. City/Town

4. State

5. Zip Code

6. Telephone #

7. Ext. #

8. DEP Facility Number (if Known)

9. Federal I.D. Number (if Known)

10. BWSC Tracking # (if Known)

### D. Application Prepared by (if different from Section B)\*

Weston & Sampson Engineers

1. Name of Firm Or Individual

55 Walkers Brook Drive, Suite 100

2. Address

Reading

MA

01867

978-532-1900

3. City/Town

4. State

5. Zip Code

6. Telephone #

7. Ext. #

Alexandra Gaspar

8. Contact Person

9. LSP Number (BWSC Permits only)

### E. Permit - Project Coordination

1. Is this project subject to MEPA review?  yes  no  
If yes, enter the project's EOE file number - assigned when an Environmental Notification Form is submitted to the MEPA unit:

EOEA File Number

### F. Amount Due

#### Special Provisions:

1.  Fee Exempt (city, town or municipal housing authority)(state agency if fee is \$100 or less).  
*There are no fee exemptions for BWSC permits, regardless of applicant status.*  
2.  Hardship Request - payment extensions according to 310 CMR 4.04(3)(c).  
3.  Alternative Schedule Project (according to 310 CMR 4.05 and 4.10).  
4.  Homeowner (according to 310 CMR 4.02).

DEP Use Only

Permit No:

Rec'd Date:

Reviewer:

Check Number

Dollar Amount

Date





Massachusetts Department of Environmental Protection  
Bureau of Resource Protection - Wetlands

**WPA Form 3 – Notice of Intent**

Massachusetts Wetlands Protection Act M.G.L. c. 131, §40

Provided by MassDEP:

MassDEP File Number

Document Transaction Number

Peabody

City/Town

**Important:**  
When filling out forms on the computer, use only the tab key to move your cursor - do not use the return key.



Note:  
Before completing this form consult your local Conservation Commission regarding any municipal bylaw or ordinance.

**A. General Information**

1. Project Location (**Note:** electronic filers will click on button to locate project site):

<u>between Wallis St and Howley St</u>	<u>Peabody</u>	<u>01960</u>
a. Street Address	b. City/Town	c. Zip Code
Latitude and Longitude:	<u>42deg31'30.602"N</u>	<u>70deg55'18.896"W</u>
	d. Latitude	e. Longitude
<u>086</u>	<u>142A</u>	
f. Assessors Map/Plat Number	g. Parcel /Lot Number	

2. Applicant:

<u>Brendan</u>	<u>Callahan</u>	
a. First Name	b. Last Name	
<u>City of Peabody</u>		
c. Organization		
<u>24 Lowell Street</u>		
d. Street Address		
<u>Peabody</u>	<u>MA</u>	<u>01960</u>
e. City/Town	f. State	g. Zip Code
<u>978-538-5780</u>	<u>brendan.callahan@peabody-ma.gov</u>	
h. Phone Number	i. Fax Number	j. Email Address

3. Property owner (required if different from applicant):  Check if more than one owner

See Attached List

a. First Name	b. Last Name	
c. Organization		
d. Street Address		
e. City/Town	f. State	g. Zip Code
h. Phone Number	i. Fax Number	j. Email address

4. Representative (if any):

<u>Alexandra</u>	<u>Gaspar</u>	
a. First Name	b. Last Name	
<u>Weston &amp; Sampson Engineers</u>		
c. Company		
<u>55 Walkers Brook Drive</u>		
d. Street Address		
<u>Reading</u>	<u>MA</u>	<u>01867</u>
e. City/Town	f. State	g. Zip Code
<u>978-532-1900</u>	<u>gaspara@wseinc.com</u>	
h. Phone Number	i. Fax Number	j. Email address

5. Total WPA Fee Paid (from NOI Wetland Fee Transmittal Form):

<u>exempt</u>		
a. Total Fee Paid	b. State Fee Paid	c. City/Town Fee Paid



Massachusetts Department of Environmental Protection  
Bureau of Resource Protection - Wetlands

# WPA Form 3 – Notice of Intent

Massachusetts Wetlands Protection Act M.G.L. c. 131, §40

Provided by MassDEP:
MassDEP File Number
Document Transaction Number
Peabody
City/Town

## A. General Information (continued)

6. General Project Description:

New riverwalk (See Appendix A for additional information)

7a. Project Type Checklist: (Limited Project Types see Section A. 7b.)

- 1.  Single Family Home
- 2.  Residential Subdivision
- 3.  Commercial/Industrial
- 4.  Dock/Pier
- 5.  Utilities
- 6.  Coastal engineering Structure
- 7.  Agriculture (e.g., cranberries, forestry)
- 8.  Transportation
- 9.  Other

7b. Is any portion of the proposed activity eligible to be treated as a limited project (including Ecological Restoration Limited Project) subject to 310 CMR 10.24 (coastal) or 310 CMR 10.53 (inland)?

- 1.  Yes  No If yes, describe which limited project applies to this project. (See 310 CMR 10.24 and 10.53 for a complete list and description of limited project types)

2. Limited Project Type

If the proposed activity is eligible to be treated as an Ecological Restoration Limited Project (310 CMR10.24(8), 310 CMR 10.53(4)), complete and attach Appendix A: Ecological Restoration Limited Project Checklist and Signed Certification.

8. Property recorded at the Registry of Deeds for:

Essex	
a. County	b. Certificate # (if registered land)
37614	457
c. Book	d. Page Number

## B. Buffer Zone & Resource Area Impacts (temporary & permanent)

- 1.  Buffer Zone Only – Check if the project is located only in the Buffer Zone of a Bordering Vegetated Wetland, Inland Bank, or Coastal Resource Area.
- 2.  Inland Resource Areas (see 310 CMR 10.54-10.58; if not applicable, go to Section B.3, Coastal Resource Areas).

Check all that apply below. Attach narrative and any supporting documentation describing how the project will meet all performance standards for each of the resource areas altered, including standards requiring consideration of alternative project design or location.







Massachusetts Department of Environmental Protection  
Bureau of Resource Protection - Wetlands

**WPA Form 3 – Notice of Intent**

Massachusetts Wetlands Protection Act M.G.L. c. 131, §40

Provided by MassDEP:

MassDEP File Number

Document Transaction Number

Peabody

City/Town

**B. Buffer Zone & Resource Area Impacts (temporary & permanent) (cont'd)**

Check all that apply below. Attach narrative and supporting documentation describing how the project will meet all performance standards for each of the resource areas altered, including standards requiring consideration of alternative project design or location.

Online Users:  
Include your document transaction number (provided on your receipt page) with all supplementary information you submit to the Department.

<u>Resource Area</u>	<u>Size of Proposed Alteration</u>	<u>Proposed Replacement (if any)</u>
a. <input type="checkbox"/> Designated Port Areas	Indicate size under Land Under the Ocean, below	
b. <input type="checkbox"/> Land Under the Ocean	_____	
	1. square feet	
	_____	
	2. cubic yards dredged	
c. <input type="checkbox"/> Barrier Beach	Indicate size under Coastal Beaches and/or Coastal Dunes below	
d. <input type="checkbox"/> Coastal Beaches	_____	_____
	1. square feet	2. cubic yards beach nourishment
e. <input type="checkbox"/> Coastal Dunes	_____	_____
	1. square feet	2. cubic yards dune nourishment

	<u>Size of Proposed Alteration</u>	<u>Proposed Replacement (if any)</u>
f. <input type="checkbox"/> Coastal Banks	_____	
	1. linear feet	
g. <input type="checkbox"/> Rocky Intertidal Shores	_____	
	1. square feet	
h. <input type="checkbox"/> Salt Marshes	_____	_____
	1. square feet	2. sq ft restoration, rehab., creation
i. <input type="checkbox"/> Land Under Salt Ponds	_____	
	1. square feet	
	_____	
	2. cubic yards dredged	
j. <input type="checkbox"/> Land Containing Shellfish	_____	
	1. square feet	
k. <input type="checkbox"/> Fish Runs	Indicate size under Coastal Banks, inland Bank, Land Under the Ocean, and/or inland Land Under Waterbodies and Waterways, above	
	_____	
	1. cubic yards dredged	
l. <input type="checkbox"/> Land Subject to Coastal Storm Flowage	_____	
	1. square feet	

4.  Restoration/Enhancement  
If the project is for the purpose of restoring or enhancing a wetland resource area in addition to the square footage that has been entered in Section B.2.b or B.3.h above, please enter the additional amount here.

\_\_\_\_\_ a. square feet of BVW \_\_\_\_\_ b. square feet of Salt Marsh

5.  Project Involves Stream Crossings

\_\_\_\_\_ a. number of new stream crossings \_\_\_\_\_ b. number of replacement stream crossings





Massachusetts Department of Environmental Protection  
Bureau of Resource Protection - Wetlands

# WPA Form 3 – Notice of Intent

Massachusetts Wetlands Protection Act M.G.L. c. 131, §40

Provided by MassDEP:	
MassDEP File Number	_____
Document Transaction Number	_____
Peabody	_____
City/Town	_____

## C. Other Applicable Standards and Requirements

- This is a proposal for an Ecological Restoration Limited Project. Skip Section C and complete Appendix A: Ecological Restoration Limited Project Checklists – Required Actions (310 CMR 10.11).

### Streamlined Massachusetts Endangered Species Act/Wetlands Protection Act Review

- Is any portion of the proposed project located in **Estimated Habitat of Rare Wildlife** as indicated on the most recent Estimated Habitat Map of State-Listed Rare Wetland Wildlife published by the Natural Heritage and Endangered Species Program (NHESP)? To view habitat maps, see the *Massachusetts Natural Heritage Atlas* or go to [http://maps.massgis.state.ma.us/PRI\\_EST\\_HAB/viewer.htm](http://maps.massgis.state.ma.us/PRI_EST_HAB/viewer.htm).

- a.  Yes  No **If yes, include proof of mailing or hand delivery of NOI to:**

**Natural Heritage and Endangered Species Program  
Division of Fisheries and Wildlife  
1 Rabbit Hill Road  
Westborough, MA 01581**

- 2021 \_\_\_\_\_  
b. Date of map

If yes, the project is also subject to Massachusetts Endangered Species Act (MESA) review (321 CMR 10.18). To qualify for a streamlined, 30-day, MESA/Wetlands Protection Act review, please complete Section C.1.c, and include requested materials with this Notice of Intent (NOI); *OR* complete Section C.2.f, if applicable. *If MESA supplemental information is not included with the NOI, by completing Section 1 of this form, the NHESP will require a separate MESA filing which may take up to 90 days to review (unless noted exceptions in Section 2 apply, see below).*

- c. Submit Supplemental Information for Endangered Species Review\*

- Percentage/acreage of property to be altered:
  - (a) within wetland Resource Area \_\_\_\_\_ percentage/acreage
  - (b) outside Resource Area \_\_\_\_\_ percentage/acreage

- Assessor's Map or right-of-way plan of site

- Project plans for entire project site, including wetland resource areas and areas outside of wetlands jurisdiction, showing existing and proposed conditions, existing and proposed tree/vegetation clearing line, and clearly demarcated limits of work \*\*
  - (a)  Project description (including description of impacts outside of wetland resource area & buffer zone)
  - (b)  Photographs representative of the site

\* Some projects **not** in Estimated Habitat may be located in Priority Habitat, and require NHESP review (see <https://www.mass.gov/endangered-species-act-mesa-regulatory-review>).

Priority Habitat includes habitat for state-listed plants and strictly upland species not protected by the Wetlands Protection Act.

\*\* MESA projects may not be segmented (321 CMR 10.16). The applicant must disclose full development plans even if such plans are not required as part of the Notice of Intent process.



Massachusetts Department of Environmental Protection  
Bureau of Resource Protection - Wetlands

## WPA Form 3 – Notice of Intent

Massachusetts Wetlands Protection Act M.G.L. c. 131, §40

Provided by MassDEP:

MassDEP File Number

Document Transaction Number

Peabody

City/Town

### C. Other Applicable Standards and Requirements (cont'd)

- (c)  MESA filing fee (fee information available at <https://www.mass.gov/how-to/how-to-file-for-a-mesa-project-review>).

Make check payable to "Commonwealth of Massachusetts - NHESP" and **mail to NHESP** at above address

*Projects altering 10 or more acres of land, also submit:*

- (d)  Vegetation cover type map of site

- (e)  Project plans showing Priority & Estimated Habitat boundaries

- (f) OR Check One of the Following

1.  Project is exempt from MESA review.  
Attach applicant letter indicating which MESA exemption applies. (See 321 CMR 10.14, <https://www.mass.gov/service-details/exemptions-from-review-for-projectsactivities-in-priority-habitat>; the NOI must still be sent to NHESP if the project is within estimated habitat pursuant to 310 CMR 10.37 and 10.59.)

2.  Separate MESA review ongoing.                      a. NHESP Tracking #                      b. Date submitted to NHESP

3.  Separate MESA review completed.  
Include copy of NHESP "no Take" determination or valid Conservation & Management Permit with approved plan.

3. For coastal projects only, is any portion of the proposed project located below the mean high water line or in a fish run?

- a.  Not applicable – project is in inland resource area only      b.  Yes     No

If yes, include proof of mailing, hand delivery, or electronic delivery of NOI to either:

South Shore - Cohasset to Rhode Island border, and  
the Cape & Islands:

North Shore - Hull to New Hampshire border:

Division of Marine Fisheries -  
Southeast Marine Fisheries Station  
Attn: Environmental Reviewer  
836 South Rodney French Blvd.  
New Bedford, MA 02744  
Email: [dmf.envreview-south@mass.gov](mailto:dmf.envreview-south@mass.gov)

Division of Marine Fisheries -  
North Shore Office  
Attn: Environmental Reviewer  
30 Emerson Avenue  
Gloucester, MA 01930  
Email: [dmf.envreview-north@mass.gov](mailto:dmf.envreview-north@mass.gov)

Also if yes, the project may require a Chapter 91 license. For coastal towns in the Northeast Region, please contact MassDEP's Boston Office. For coastal towns in the Southeast Region, please contact MassDEP's Southeast Regional Office.

- c.  Is this an aquaculture project?                      d.  Yes     No

If yes, include a copy of the Division of Marine Fisheries Certification Letter (M.G.L. c. 130, § 57).





Massachusetts Department of Environmental Protection  
Bureau of Resource Protection - Wetlands

**WPA Form 3 – Notice of Intent**

Massachusetts Wetlands Protection Act M.G.L. c. 131, §40

Provided by MassDEP:

MassDEP File Number

Document Transaction Number

Peabody

City/Town

**C. Other Applicable Standards and Requirements (cont'd)**

**Online Users:**  
Include your document transaction number (provided on your receipt page) with all supplementary information you submit to the Department.

- 4. Is any portion of the proposed project within an Area of Critical Environmental Concern (ACEC)?  
 a.  Yes  No      If yes, provide name of ACEC (see instructions to WPA Form 3 or MassDEP Website for ACEC locations). **Note:** electronic filers click on Website.  
 b. ACEC

---

- 5. Is any portion of the proposed project within an area designated as an Outstanding Resource Water (ORW) as designated in the Massachusetts Surface Water Quality Standards, 314 CMR 4.00?  
 a.  Yes  No
- 6. Is any portion of the site subject to a Wetlands Restriction Order under the Inland Wetlands Restriction Act (M.G.L. c. 131, § 40A) or the Coastal Wetlands Restriction Act (M.G.L. c. 130, § 105)?  
 a.  Yes  No
- 7. Is this project subject to provisions of the MassDEP Stormwater Management Standards?  
 a.  Yes. Attach a copy of the Stormwater Report as required by the Stormwater Management Standards per 310 CMR 10.05(6)(k)-(q) and check if:
  - 1.  Applying for Low Impact Development (LID) site design credits (as described in Stormwater Management Handbook Vol. 2, Chapter 3)
  - 2.  A portion of the site constitutes redevelopment
  - 3.  Proprietary BMPs are included in the Stormwater Management System.
 b.  No. Check why the project is exempt:
  - 1.  Single-family house
  - 2.  Emergency road repair
  - 3.  Small Residential Subdivision (less than or equal to 4 single-family houses or less than or equal to 4 units in multi-family housing project) with no discharge to Critical Areas.

**D. Additional Information**

- This is a proposal for an Ecological Restoration Limited Project. Skip Section D and complete Appendix A: Ecological Restoration Notice of Intent – Minimum Required Documents (310 CMR 10.12).

Applicants must include the following with this Notice of Intent (NOI). See instructions for details.

**Online Users:** Attach the document transaction number (provided on your receipt page) for any of the following information you submit to the Department.

- 1.  USGS or other map of the area (along with a narrative description, if necessary) containing sufficient information for the Conservation Commission and the Department to locate the site. (Electronic filers may omit this item.)
- 2.  Plans identifying the location of proposed activities (including activities proposed to serve as a Bordering Vegetated Wetland [BVW] replication area or other mitigating measure) relative to the boundaries of each affected resource area.



Massachusetts Department of Environmental Protection  
Bureau of Resource Protection - Wetlands

# WPA Form 3 – Notice of Intent

Massachusetts Wetlands Protection Act M.G.L. c. 131, §40

Provided by MassDEP:

MassDEP File Number

Document Transaction Number

Peabody

City/Town

## D. Additional Information (cont'd)

3.  Identify the method for BVW and other resource area boundary delineations (MassDEP BVW Field Data Form(s), Determination of Applicability, Order of Resource Area Delineation, etc.), and attach documentation of the methodology.

4.  List the titles and dates for all plans and other materials submitted with this NOI.

Peabody Riverwalk

a. Plan Title

Weston & Sampson Engineers

b. Prepared By

March 2021

d. Final Revision Date

James Pearson, PE

c. Signed and Stamped by

1"=20'

e. Scale

f. Additional Plan or Document Title

g. Date

5.  If there is more than one property owner, please attach a list of these property owners not listed on this form.

6.  Attach proof of mailing for Natural Heritage and Endangered Species Program, if needed.

7.  Attach proof of mailing for Massachusetts Division of Marine Fisheries, if needed.

8.  Attach NOI Wetland Fee Transmittal Form

9.  Attach Stormwater Report, if needed.

## E. Fees

1.  Fee Exempt: No filing fee shall be assessed for projects of any city, town, county, or district of the Commonwealth, federally recognized Indian tribe housing authority, municipal housing authority, or the Massachusetts Bay Transportation Authority.

Applicants must submit the following information (in addition to pages 1 and 2 of the NOI Wetland Fee Transmittal Form) to confirm fee payment:

2. Municipal Check Number

3. Check date

4. State Check Number

5. Check date

6. Payor name on check: First Name

7. Payor name on check: Last Name





Massachusetts Department of Environmental Protection  
Bureau of Resource Protection - Wetlands

# WPA Form 3 – Notice of Intent

Massachusetts Wetlands Protection Act M.G.L. c. 131, §40

Provided by MassDEP:
MassDEP File Number
Document Transaction Number
Peabody
City/Town

## F. Signatures and Submittal Requirements

I hereby certify under the penalties of perjury that the foregoing Notice of Intent and accompanying plans, documents, and supporting data are true and complete to the best of my knowledge. I understand that the Conservation Commission will place notification of this Notice in a local newspaper at the expense of the applicant in accordance with the wetlands regulations, 310 CMR 10.05(5)(a).

I further certify under penalties of perjury that all abutters were notified of this application, pursuant to the requirements of M.G.L. c. 131, § 40. Notice must be made by Certificate of Mailing or in writing by hand delivery or certified mail (return receipt requested) to all abutters within 100 feet of the property line of the project location.

Brendan Callahan  
1. Signature of Applicant

05/17/21  
2. Date

[Signature]  
5. Signature of Representative (if any)

6/2/2021  
4. Date  
6. Date

### For Conservation Commission:

Two copies of the completed Notice of Intent (Form 3), including supporting plans and documents, two copies of the NOI Wetland Fee Transmittal Form, and the city/town fee payment, to the Conservation Commission by certified mail or hand delivery.

### For MassDEP:

One copy of the completed Notice of Intent (Form 3), including supporting plans and documents, one copy of the NOI Wetland Fee Transmittal Form, and a **copy** of the state fee payment to the MassDEP Regional Office (see Instructions) by certified mail or hand delivery.

### Other:

If the applicant has checked the "yes" box in any part of Section C, Item 3, above, refer to that section and the Instructions for additional submittal requirements.

The original and copies must be sent simultaneously. Failure by the applicant to send copies in a timely manner may result in dismissal of the Notice of Intent.



**Massachusetts Department of Environmental Protection**  
 Bureau of Resource Protection - Wetlands  
**NOI Wetland Fee Transmittal Form**  
 Massachusetts Wetlands Protection Act M.G.L. c. 131, §40

**Important:** When filling out forms on the computer, use only the tab key to move your cursor - do not use the return key.

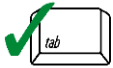

**A. Applicant Information**

1. Location of Project:

Wallis Street to Howley Street

a. Street Address

exempt

c. Check number

Peabody

b. City/Town

exempt

d. Fee amount

2. Applicant Mailing Address:

Brendan

a. First Name

City of Peabody

c. Organization

24 Lowell Street

d. Mailing Address

Peabody

e. City/Town

978-538-5780

h. Phone Number

i. Fax Number

Callahan

b. Last Name

MA

f. State

01960

g. Zip Code

brendhan.callahan@peabody-ma.gov

j. Email Address

3. Property Owner (if different):

See Attached List

a. First Name

b. Last Name

c. Organization

d. Mailing Address

e. City/Town

f. State

g. Zip Code

h. Phone Number

i. Fax Number

j. Email Address

**B. Fees**

Fee should be calculated using the following process & worksheet. **Please see Instructions before filling out worksheet.**

**Step 1/Type of Activity:** Describe each type of activity that will occur in wetland resource area and buffer zone.

**Step 2/Number of Activities:** Identify the number of each type of activity.

**Step 3/Individual Activity Fee:** Identify each activity fee from the six project categories listed in the instructions.

**Step 4/Subtotal Activity Fee:** Multiply the number of activities (identified in Step 2) times the fee per category (identified in Step 3) to reach a subtotal fee amount. Note: If any of these activities are in a Riverfront Area in addition to another Resource Area or the Buffer Zone, the fee per activity should be multiplied by 1.5 and then added to the subtotal amount.

**Step 5/Total Project Fee:** Determine the total project fee by adding the subtotal amounts from Step 4.

**Step 6/Fee Payments:** To calculate the state share of the fee, divide the total fee in half and subtract \$12.50. To calculate the city/town share of the fee, divide the total fee in half and add \$12.50.

To calculate filing fees, refer to the category fee list and examples in the instructions for filling out WPA Form 3 (Notice of Intent).





Massachusetts Department of Environmental Protection  
 Bureau of Resource Protection - Wetlands  
**NOI Wetland Fee Transmittal Form**  
 Massachusetts Wetlands Protection Act M.G.L. c. 131, §40

**B. Fees** (continued)

Step 1/Type of Activity	Step 2/Number of Activities	Step 3/Individual Activity Fee	Step 4/Subtotal Activity Fee
exempt			exempt

**Step 5/Total Project Fee:** \_\_\_\_\_

**Step 6/Fee Payments:**

Total Project Fee:	<u>exempt</u>
	a. Total Fee from Step 5
State share of filing Fee:	<u>exempt</u>
	b. 1/2 Total Fee <b>less</b> \$12.50
City/Town share of filing Fee:	<u>exempt</u>
	c. 1/2 Total Fee <b>plus</b> \$12.50

**C. Submittal Requirements**

- a.) Complete pages 1 and 2 and send with a check or money order for the state share of the fee, payable to the Commonwealth of Massachusetts.

Department of Environmental Protection  
 Box 4062  
 Boston, MA 02211

- b.) **To the Conservation Commission:** Send the Notice of Intent or Abbreviated Notice of Intent; a **copy** of this form; and the city/town fee payment.

**To MassDEP Regional Office** (see Instructions): Send a copy of the Notice of Intent or Abbreviated Notice of Intent; a **copy** of this form; and a **copy** of the state fee payment. (E-filers of Notices of Intent may submit these electronically.)

**Property Owner Information:**

**Right of Way - Wallis Street**

Owner CITY OF PEABODY

Owner Address 24 LOWELL ST, PEABODY, MA 01960

**Right of Way - Caller Street**

Owner CITY OF PEABODY

Owner Address 24 LOWELL ST, PEABODY, MA 01960

**Right of Way - Howley Street**

Owner CITY OF PEABODY

Owner Address 24 LOWELL ST, PEABODY, MA 01960

**Boston Main Railroad**

(No Property Address or Property ID per Town Assessor)

Owner B&M RAILROAD

PAN AM SYSTEMS (formerly Guilford Transportation Industries)

Owner Address 1700 IRON HORSE PARK, NORTH BILLERICA, MA 01862

**Property Address 20 HOWLEY ST**

Property ID 086-162

Owner THE AZOREAN BROTHERHOOD OF THE

DIVINE HOLY GHOST INC C/O PINTO MARIO

Owner Address 11 HINGSTON ST, PEABODY, MA 01960

**Property Address 166 MAIN ST (R)**

Property ID 086-150A

Owner RIVERWALK PLACE LLC

C/O BIBBY REAL ESTATE CORP

Owner Address PO BOX 110, LYNN, MA 01903

**Property Address 18 HOWLEY ST**

Property ID 086-150

Owner AZOREAN BROTHERHOOD OF THE

DIVINE HOLY GHOST INC

Owner Address 20 HOWLEY ST, PEABODY, MA 01960

**Property Address 21 CALLER ST**

Property ID 086-151X

Owner RIVER DEVELOPMENT LLC

Owner Address 21 CALLER ST - SUITE 1, PEABODY, MA 01960



**Property Address 24 CALLER ST**

Property ID 086-142A

Owner CITY OF PEABODY

Owner Address 24 LOWELL ST, PEABODY, MA 01960

**Property Address 13 WALLIS ST**

Property ID 085-041A

Owner DIMAMBRO ALFRED JR TRUSTEE

REGENCY REALTY TRUST

Owner Address P.O. BOX 708, PEABODY, MA 01960

APPENDIX A  
PROJECT DESCRIPTION



## Project Description

### Background

In 2018, the City of Peabody (the City) was awarded a Municipal Vulnerability Preparedness (MVP) Action Grant by the Massachusetts Executive Office of Energy & Environmental Affairs (MassEEA). The MVP grant will allow the City to explore options for improving the flood resiliency of Peabody Square and was awarded based on a comprehensive project proposal to specifically target a stretch of the North River Canal that will improve flood resilience, address site contamination from historic use as a tannery district and evaluate a park resource and Riverwalk that would enhance public access and vitality of the area.

### Site Description

The project site is in an urban industrial area of Peabody, between Wallis and Howley Streets, and crosses Caller Street. The south side of the North River Canal along the project limits abuts seven (7) privately owned properties, from west to east: 13 Wallis Street, 24 Caller Street [Caller Street crossing], 21 Caller Street, 18 Howley Street, 20 Howley Street, 166 Main Street (R), and MBTA property.

The south canal wall along the length of the project limits consists of multiple sections including earthen embankment (or possible buried wall), a stacked timber railroad tie structure behind an earth embankment, reinforced concrete, granite blocks, or stone or stone rubble sections. Wall heights range from about 4 to 6 feet above the canal bottom. The wall's condition varies over its length, ranging from good, in need of minor or no repairs, to poor, requiring full or partial reconstruction.

### Scope of Work

The proposed Riverwalk will be approximately 1,600 feet in length, following along the canal in the urban industrial section of downtown Peabody from approximately Wallis Street to Howley Street. Part of the project's scope of work includes replacing the south canal wall with a new wall at a lower elevation with a stabilized slope with a turf reinforcement mat and vegetation. The new wall will consist of driven steel sheet pilings located approximately 2 feet inland from the existing canal wall. The sheet piling wall will be craned into place and driven to specific depths. The Riverwalk will consist of an 8-foot wide asphalt path with 4 feet of vegetative buffer on each side where sufficient space permits. There will also be 4 separate sections of boardwalk constructed which will include helical pile footings. Additionally, a porous paver "art walk" will also be constructed as well a public deck supported by concrete post footings. Plantings will consist of native species and seed mixes. Pedestrian and street lights will be installed as well as rapid flashing beacons at street crossings.

### Environmental Considerations

Resources that will be impacted by this project include Bordering Land Subject to Flooding, Bank, and Riverfront Area. Please see below for the General Performance Standards for each resource and how this project will approach them.

#### Bordering Land Subject to Flooding - General Performance Standards

- 1. Compensatory storage shall be provided for all flood storage volume that will be lost as the result of a proposed project within Bordering Land Subject to Flooding.**

See below cut and fill table that accounts for the change in flood storage as a result of this project.

Contour El. (ft)	Fill (cuft)	Compensatory Storage (cuft)	Fill (CY)	Storage (CY)
11-12	197±	1620±	7±	60±
12-13	1418±	3356±	53±	124±
13-14	898±	911±	33±	34±

- 2. Work within Bordering Land Subject to Flooding, including that work required to provide the above-specified compensatory storage, shall not restrict flows so as to cause an increase in flood stage or velocity.**
  
- 3. Work in those portions of bordering land subject to flooding found to be significant to the protection of wildlife habitat shall not impair its capacity to provide important wildlife habitat functions ...**

This proposed project is not within any of the habitat areas identified by the Mass Wildlife’s Natural Heritage & Endangered Species Program (NHESP) on MassGIS data layers including NHESP Estimated Habitats of Rare Wildlife, NHESP Priority Habitats of Rare Species, NHESP Certified Vernal Pools, and NHESP Potential Vernal Pools. Environmental resources map outlining these areas are attached in this package.

Bank – General Performance Standards

Where the presumption set forth in 310 CMR 10.54(3) is not overcome, any proposed work on a Bank shall not impair the following:

- 1. the physical stability of the Bank;**

As mentioned in the Scope of Work, this project will enhance the slopes stability. Turf reinforcement mat and vegetation will be added to accomplish this.

- 2. the water carrying capacity of the existing channel within the Bank;**

The new canal wall will be set back which will increase the width of the river along the length of the project. Proper resource protection will be utilized to ensure this process does not have any severe impact to nearby resource areas. Resource protection will include compost filter tubes on land and siltation curtain in the river to minimize sediment migration into the river during construction activities. The new, gentler bank slope will enhance slope stability. In addition, the new bank will be stabilized with turf reinforcement mat and vegetation.

- 3. ground water and surface water quality;**

There will be no impacts to ground water and surface water quality.



**4. the capacity of the Bank to provide breeding habitat, escape cover and food for fisheries;**

This project will not negatively impact the capacity of the Bank to provide breeding habitat, escape cover, and food for fisheries. As we are increasing the width of the river, there may be more habitat available to fisheries. In addition, the existing bank currently exists of stone wall, so it is not providing much habitat in its current state.

**5. the capacity of the Bank to provide important wildlife habitat functions. A project or projects on a single lot, for which Notice(s) of Intent is filed on or after November 1,1987, that (cumulatively) alter(s) up to 10% or 50 feet (whichever is less) of the length of the bank found to be significant to the protection of wildlife habitat, shall not be deemed to impair its capacity to provide important wildlife habitat functions. In the case of a bank of a river or an intermittent stream, the impact shall be measured on each side of the stream or river. Additional alterations beyond the above threshold may be permitted if they will have no adverse effects on wildlife habitat, as determined by procedures contained in 310 CMR 10.60.**

This project will not negatively impact the capacity of the bank to provide wildlife habitat functions. The bank is already made up of degraded area (stone wall). This project will improve the quality of the bank, and the ability of the bank to provide wildlife habitat functions.

Riverfront Area – General Performance Standards

The area where work will occur (Wallis/Howley Street area) is considered already altered area. As such, since the limit of work is fully within the riverfront area, work at this site is considered re-development work in riverfront area. Each standard for work in riverfront for redevelopment projects area (per 310 CMR 10.58 (5)) are provided below, followed by an explanation on how the project meets each standard.

**(a) At a minimum, proposed work shall result in an improvement over existing conditions of the capacity of the riverfront area to protect the interests identified in M.G.L. c. 131 § 40.**

Because work will involve improving bank stability and adding native plantings to the area, this project will result in an improvement over existing conditions of the capacity of the riverfront area to protect the interests identified in M.G.L. c. 131 § 40.

**(b) Stormwater management is provided according to standards established by the Department.**

Per Appendix G of the Notice of Intent, this project will adhere to the stormwater standards established by the Department.

**(c) Within 200 foot riverfront areas, proposed work shall not be located closer to the river than existing conditions or 100 feet, whichever is less, or not closer than existing conditions within 25 foot riverfront areas, except in accordance with 310 CMR 10.58(5)(f) or (g).**

The work will all be within already altered area (roadway, buildings, parking lot, manicured lawn, train tracks).

**(d) Proposed work, including expansion of existing structures, shall be located outside the riverfront area or toward the riverfront area boundary and away from the river, except in accordance with 310 CMR 10.58(5)(f) or (g).**

Work will not be outside the riverfront area or toward the riverfront area boundary, however the work will be in accordance with 310 CMR 10.58(5)(f) as much of the work is within a degraded riverfront area (train tracks, urban industrial area, neither of which provide optimal riverfront area habitat).

**(e) The area of proposed work shall not exceed the amount of degraded area, provided that the proposed work may alter up to 10% if the degraded area is less than 10% of the riverfront area, except in accordance with 310 CMR 10.58(5)(f) or (g).**

The area of proposed work within the riverfront area is 110,305 sf. Total riverfront area on the parcel is 612,400 sf. Thus, 18 percent of the site's riverfront area will be altered. The work will be in accordance with 310 CMR 10.58(5)(f) as much of the work is within a degraded riverfront area.

**(f) When an applicant proposes restoration on-site of degraded riverfront area, alteration may be allowed notwithstanding the criteria of 310 CMR 10.58(5)(c), (d), and (e) at a ratio in square feet of at least 1:1 of restored area to area of alteration not conforming to the criteria. Areas immediately along the river shall be selected for restoration. Alteration not conforming to the criteria shall begin at the riverfront area boundary. Restoration shall include:**

- 1. removal of all debris, but retaining any trees or other mature vegetation;**
- 2. grading to a topography which reduces runoff and increases infiltration;**
- 3. coverage by topsoil at a depth consistent with natural conditions at the site; and**
- 4. seeding and planting with an erosion control seed mixture, followed by plantings of herbaceous and woody species appropriate to the site;**

Restoration efforts will include removal of all debris, and the addition of native species and seed mixes to serve as a vegetative buffer.

**(g) When an applicant proposes mitigation either on-site or in the riverfront area within the same general area of the river basin, alteration may be allowed notwithstanding the criteria of 310 CMR 10.58(5)(c), (d), or (e) at a ratio in square feet of at least 2:1 of mitigation area to area of alteration not conforming to the criteria or an equivalent level of environmental protection where square footage is not a relevant measure. Alteration not conforming to the criteria shall begin at the riverfront area boundary. Mitigation may include off-site restoration of riverfront areas, conservation restrictions under M.G.L. c. 184, §§ 31 through 33 to preserve undisturbed riverfront areas that could be otherwise altered under 310 CMR 10.00, the purchase of development rights within the riverfront area, the restoration of bordering vegetated wetland, projects to remedy an existing adverse impact on the interests identified in M.G.L. c. 131, § 40 for which the applicant is not legally responsible, or similar activities undertaken voluntarily by the applicant which will support a determination by the issuing authority of no significant adverse impact. Preference shall be given to potential mitigation projects, if any, identified in a River Basin Plan approved by the Secretary of the Executive Office of Energy and Environmental Affairs.**



Not applicable.

APPENDIX B  
ALTERNATIVES ANALYSIS



## TABLE OF CONTENTS

	Page
EXECUTIVE SUMMARY .....	ES-1
TABLE OF CONTENTS .....	i
LIST OF FIGURES .....	.iii
LIST OF TABLES .....	.iii
LIST OF APPENDICES .....	.iii
1.0 INTRODUCTION.....	1-1
1.1 Project Understanding .....	1-1
2.0 DESCRIPTION OF EXISTING SITE CONDITIONS .....	2-1
2.1 Existing Wall Structure .....	2-1
2.2 Existing Subsurface Conditions.....	2-1
2.2.1 Geologic Setting .....	2-1
2.2.2 Subsurface Explorations.....	2-1
2.3 Existing Soil Contamination .....	2-2
2.4 Existing Flood Issues .....	2-2
3.0 SUBSURFACE INVESTIGATION ACTIVITIES .....	3-1
3.1 Subsurface Conditions .....	3-1
3.2 Groundwater .....	3-2
3.3 Geotechnical Laboratory Testing .....	3-2
3.4 Conditions of Existing Canal Wall.....	3-2
3.5 Disposal Characterization Sampling and Analysis .....	3-3
4.0 ENVIRONMENTAL CONSIDERATINOS AND RECOMMENDATIONS .....	4-1
4.1 MCP Regulatory Considerations .....	4-1
4.1.1 13 Wallis Street .....	4-1
4.1.2 24 Caller Street.....	4-2
4.1.3 21 Caller Street.....	4-4
4.1.4 18 Howley Street.....	4-6
4.1.5 166R Main Street .....	4-7
4.2 MCP Environmental Regulatory Summary and Recommendations .....	4-8
5.0 GEOTECHNICAL DESIGN AND CONSTRUCTION RECOMMENDATIONS.....	5-1
5.1 Existing Fill and Organics .....	5-1
5.2 Retaining Walls.....	5-1
5.2.1 Lateral Pressures .....	5-1
5.2.2 Seismic Considerations.....	5-2
5.3 Construction Considerations .....	5-3
5.3.1 Fill Materials and Placement .....	5-3
6.0 WALL ALTERNATIVE ANALYSIS.....	6-1

6.1	Alternative A – Rip Rap Slope.....	6-1
6.1.1	Resilience.....	6-2
6.1.2	Durability.....	6-2
6.1.3	Environmental Impact.....	6-2
6.1.4	Constructability & Construction Schedule.....	6-2
6.1.5	Right-of-Way.....	6-2
6.2	Alternative B – Vegetative Berm Above Rip Rap Slope.....	6-2
6.2.1	Resilience.....	6-3
6.2.2	Durability.....	6-3
6.2.3	Environmental Impact.....	6-3
6.2.4	Constructability & Construction Schedule.....	6-3
6.2.5	Right-of-Way.....	6-3
6.3	Alternative C – Sheet Pile Wall.....	6-4
6.3.1	Resilience.....	6-4
6.3.2	Durability.....	6-4
6.3.3	Environmental Impact.....	6-4
6.3.4	Constructability & Construction Schedule.....	6-5
6.3.5	Right-of-Way.....	6-5
6.4	Alternative D – Cantilever Concrete Retaining Wall.....	6-5
6.4.1	Resilience.....	6-5
6.4.2	Durability.....	6-5
6.4.3	Environmental Impact.....	6-5
6.4.4	Constructability & Construction Schedule.....	6-5
6.4.5	Right-of-Way.....	6-6
6.5	Alternative E – Stone Masonry Wall.....	6-6
6.5.1	Resilience.....	6-6
6.5.2	Durability.....	6-6
6.5.3	Environmental Impact.....	6-6
6.5.4	Constructability & Construction Schedule.....	6-6
6.5.5	Right-of-Way.....	6-7
7.0	REFERENCES INCREMENTAL APPROACH.....	7-1
8.0	PERMITTING STRATEGY.....	8-1
8.1	Introduction.....	8-1
8.2	Environmental Permitting Strategy.....	8-2
8.2.1	Alternative A – Rip Rap Slope.....	8-2
8.2.2	Alternative B – Vegetative Berm Over Rip Rap Slope.....	8-3
8.2.3	Alternative C – Sheet Pile Wall.....	8-5
8.2.4	Alternative D – Cantilever Concrete Retaining Wall.....	8-7
8.2.5	Alternative E – Stone Masonry Wall.....	8-9
8.3	Permitting Summary and Recommendations.....	8-10
9.0	COMPREHENSIVE COMPARATIVE MATRIX.....	9-1
10.0	CONCLUSIONS.....	10-1
11.0	REFERENCES.....	11-1



**LIST OF FIGURES**

Figure 1 ..... Locus Plan  
Figure 2 ..... Site Plan

**LIST OF TABLES**

Table 1 ..... Summary of Existing Conditions  
Table 2 ..... Summary of Subsurface Conditions  
Table 3 ..... Summary of Soil Analytical Results - Disposal Characterization  
Table 4 ..... Summary of Soil Transportation & Disposal Cost Estimates

**LIST OF APPENICES**

Appendix A ..... 2017 Riverwalk along North River Corridor – South Wall Evaluation  
Appendix B ..... Previous Subsurface Explorations – Soil Borings & Photographs  
Appendix C ..... 2017 Limited Subsurface Environmental Investigations – Proposed Riverwalk Area  
Appendix D ..... Soil Boring and Test Pit Logs – November 2018  
Appendix E ..... Geotechnical Analytical Laboratory Report  
Appendix F ..... Disposal Characterization Analytical Laboratory Report  
Appendix G ..... Geotechnical Engineering Report- GBA, Inc.  
Appendix H ..... Typical Cross Sections and Alignments of Alternatives  
Appendix I ..... Wall Alternative Cost Estimates  
Appendix J ..... Resilience Evaluation Report  
Appendix K ..... Summary of Potential Permits  
Appendix L ..... Summary Table of Permitting Variables  
Appendix M ..... Potential Permitting Schedule

.....

## EXECUTIVE SUMMARY

In 2018, the City of Peabody (the City) was awarded a Municipal Vulnerability Preparedness (MVP) Action Grant by the Massachusetts Executive Office of Energy & Environmental Affairs (MassEEA). The MVP grant will allow the City to explore options for improving the flood resiliency of Peabody Square and was awarded based on a comprehensive project proposal to specifically target a stretch of the North River Canal that will improve flood resilience, address site contamination from historic use as a tannery district and evaluate a park resource and Riverwalk that would enhance public access and vitality of the area.

The proposed Riverwalk will be approximately 1,600 feet in length, following along the canal in the urban industrial section of downtown Peabody from approximately Wallis Street to Howley Street. The existing wall on the south side of the canal over the length of the proposed Riverwalk varies drastically in condition from good to poor. In 2017, Weston & Sampson determined that prior to the construction of the Riverwalk, the south canal wall would need to be repaired / replaced in order to support the construction of the proposed Riverwalk.

Weston & Sampson, on behalf of the City, has performed subsurface explorations immediately behind the Canal wall to obtain back of existing wall information, including wall type, dimensions, and subsurface conditions. Using that information, Weston & Sampson was able to perform preliminary geotechnical and structural analyses to evaluate repair/replacement design alternatives for the wall. Additional grant activities also included limited environmental sampling activities to better understand potential regulatory obligations under the Massachusetts Contingency Plan (MCP), 310 CMR 40.0000.

Weston & Sampson has developed five (5) design repair/replacement alternatives for the south canal wall to support the construction of a Riverwalk and improve flood resilience along the North River Canal. Wall alternatives include options for replacing the current wall with a new wall, as well as green options like providing protection with an earthen berm. Preliminary engineering cost estimates for each alternative have been provided. Weston & Sampson then conducted a preliminary analysis to evaluate the five (5) wall alternatives based on factors such as resiliency, anticipated durability, environmental impact, permitting, schedule, and costs. This was used to rank and prioritize alternatives for the wall.

Based upon the findings and comparative evaluations presented in this report, Alternative C – Sheet Pile Option 2 with Sloped Bank ranked as the highest scoring alternative. This alternative would provide the most additional flood storage with relatively low total cost and minimal maintenance when compared to other alternatives. In addition, Alternative C – Sheet Pile Option 2 with Sloped Bank requires a reasonable easement width from private property owners, would allow for the design of an adjacent Riverwalk, does not require any material to be dredged from the canal and had the highest total permitting favorability.

However, while this alternative works from a conceptual engineering and permitting evaluation perspective, Alternative C – Option 2 may not be feasible along the entire length of the wall due to existing structures and grade and may require a limited length of one of the other wall alternatives to be considered. The feasibility in such areas will need to be further evaluated during the preliminary design process and may depend on other factors such as property easements or acquisition potential.

Other well-scoring alternatives were: Alternative C - Sheet Pile Wall - Option 1; Alternative B - Vegetative Berm - Option 1; and Alternative A - Rip Rap - Option 1. The highest-ranking wall option, Alternative C - Sheet Pile Wall - Option 2 with Sloped Bank, combines all the favorable qualities of Alternatives A and B with the favorable qualities of Alternative C - Sheet Pile - Option 1 and provides the highest percentage of potential parcel protection for all six flood-climate change projection scenarios.



## 1.0 INTRODUCTION

The City of Peabody suffers from recurring flooding which is expected to worsen from climate change, including sea level rise and increased precipitation frequency and intensity. In 2018, the City of Peabody (the City) was awarded a Municipal Vulnerability Preparedness (MVP) Action Grant by the Massachusetts Executive Office of Energy & Environmental Affairs (MassEEA). The MVP grant will allow the City to explore options for improving the flood resiliency of Peabody Square and was awarded based on a comprehensive project proposal to specifically target a stretch of the North River Canal that will improve flood resilience, address site contamination from historic use as a tannery district and evaluate a park resource and proposed Riverwalk that would enhance public access and vitality of the area. The North River Canal is a straightened and walled reach of the North River connecting Peabody Square to the tidal reach of the North River near the Salem-Peabody municipal boundary. The North River drainage basin discharges into Salem Sound

The proposed Riverwalk will be approximately 1,600 feet in length, following along the canal (i.e. Proctor Brook) in the urban industrial section of downtown Peabody from approximately Wallis Street to Howley Street. The south side of the canal abuts six (6) privately owned properties (from west to east: 13 Wallis Street, 24 Caller Street, [Caller Street crossing], 21 Caller Street, 18 Howley Street, 166R Main Street, and Massachusetts Bay Transit Authority (MBTA) property). The existing wall on the south side of the canal over the length of the proposed Riverwalk varies drastically in condition from good to poor. In 2017, Weston & Sampson determined that prior to the construction of the Riverwalk, the south canal wall would need to be repaired / replaced in order to support the construction of the proposed Riverwalk.

This report presents the results of Weston & Sampson's geotechnical and structural feasibility studies that were conducted in the target area along the North River Canal as part of MVP Grant activities. The purpose of this engineering evaluation was to preliminarily explore subsurface conditions and assess geotechnical, environmental, structural, and regulatory permitting considerations for repair/replacement alternatives for the North River Canal south wall to support the proposed Riverwalk.

The recommendations presented in this report are based on Weston & Sampson's understanding of the proposed project as described herein, subsurface conditions encountered at discrete exploration locations, and the provisions of the Limitations, provided in Section 11, of this report. Additional investigations, testing, and recommendations will be necessary for final design.

### 1.1 Project Understanding

The project site is in an urban industrial area of Peabody, between Wallis and Howley Streets, and crosses Caller Street, as shown in **Figure 1 – Site Locust**. The south side of the North River Canal along the project limits abuts six (6) privately owned properties, from west to east: 13 Wallis Street, 24 Caller Street, [Caller Street crossing], 21 Caller Street, 18 Howley Street, 166 Main Street (R), and MBTA property. Refer to **Figure 1** and **Figure 2 – Site Plan** for the property limits, and **Table 1 – Summary of Existing Conditions** for a summary of existing conditions within the project area. Construction of the park and Riverwalk will require property acquisition or easements on these private properties.

The south canal wall along the length of the project limits consists of multiple sections including earthen embankment (or possible buried wall), a stacked timber railroad tie structure behind an earth embankment, reinforced concrete, granite blocks, or stone or stone rubble sections. Wall heights range from about 4 to 6 feet above the canal bottom. The wall's condition varies over its length, ranging from good, in need of minor or no repairs, to poor, requiring full or partial reconstruction. Refer to Weston & Sampson's report titled "Riverwalk along North River Corridor – South Wall Evaluation," dated June 2,

2017, in **Appendix A** for detailed description of the existing wall types and conditions along the project alignment.

The North River Canal has a history of flooding. The overall goal of the MVP grant project is to evaluate and incorporate resilient design measures to provide flood protection during storm events, which may include floodwater storage, increased canal wall height, and/or widening of the canal.

Proposed site development plans, including site grading, canal wall alignment and proposed elevations, were not developed at the time of this report.



## 2.0 DESCRIPTION OF EXISTING SITE CONDITIONS

### 2.1 Existing Wall Structure

In May and June of 2017, Weston & Sampson documented the existing conditions of the south wall in a report titled “Riverwalk along North River Corridor – South Wall Evaluation,” dated June 2, 2017. In the report, Weston & Sampson recommended repair or replacement to sections of the wall for support of new loads associated with the proposed Riverwalk. The visual inspection performed on the south wall of the North River Corridor revealed that the wall’s condition varies drastically over its length. Conditions range from “good,” which need minor or no repairs, to “poor,” which require full or partial reconstruction. Causes of deterioration include waterflow, overgrown vegetation (roots), and changes in the surrounding land conditions due to lack of maintenance. Materials used in construction of the wall vary along the wall’s length and include earth embankment or buried wall, a timber tie structure behind earth embankment, reinforced concrete, granite blocks, and stone or stone rubble.

### 2.2 Existing Subsurface Conditions

#### 2.2.1 Geologic Setting

Based on information available from the Massachusetts Office of Geographic Information (MassGIS), surficial geology conditions at the site are mapped as fine glaciomarine deposits overlying thin till and bedrock at depths less than 50 feet. Bedrock in the area of the site is mapped as the Peabody Granite formation. The nearest mapped bedrock outcrops are located approximately a quarter mile from the site, north of the North River Canal.

#### 2.2.2 Subsurface Explorations

A total of ten (10) borings and five (5) test pits were completed in the past during previous subsurface explorations in the area. The following studies provide subsurface data relevant to our geotechnical assessment. The explorations are described below.

##### 2002 Explorations by Geotechnical Services, Inc:

Six (6) borings, herein referred to as B-1(GSI) through B-6(GSI), were completed at the 13 Wallis Street property between October 31 and November 4, 2002 for a multi-family housing development proposed at the time. Boring depths ranged from 17 to 40 feet. The borings were performed by New Hampshire Boring, Inc. (now New England Boring Contractors) of Derry, New Hampshire, and logged by Geotechnical Services, Inc. (GSI) of Goffstown, New Hampshire. Approximate boring locations are shown in **Figure 2**, and the boring logs prepared by GSI are included *in Appendix B – Previous Subsurface Explorations – Boring Logs*.

##### 2007 Explorations by Weston & Sampson:

Weston & Sampson explored subsurface conditions in the project area by advancing four (4) borings (WS-1 through WS-4) between March 21 and 23, 2007 during a previous phase of the North River Canal project. The borings were advanced to depths up to 41 feet below grade at the approximate locations shown on **Figure 2**. Geologic Earth Explorations, Inc of Norfolk, MA performed the borings using drive and wash drilling methods. Boring logs from the 2007 explorations are included in **Appendix B**.

The 2007 explorations also included five (5) test pits (TP-1 through TP-5) to observe the back of the canal wall. Test pits TP-1 through TP-4 were located at the north wall of the canal, outside of the current project area. TP-5 was located within the project area at 13 Wallis Street, at the approximate location shown on **Figure 2** (labelled TP-5(2007) on the figure). Photographs showing the conditions observed

in the test pit are included in *Appendix B*.

### 2.3 Existing Soil Contamination

There is known or suspected soil contamination along the proposed Riverwalk area that will need to be addressed as part of proposed wall repair activities and construction of the Riverwalk. Most of the area was formerly a tannery and it has known and potential environmental impacts. Weston & Sampson, on behalf of the City, conducted limited subsurface environmental assessments at several of the properties within the proposed Riverwalk area in 2017. Copies of the reports are provided in Appendix C - 2017 Limited Subsurface Investigations – Proposed Riverwalk Area. Additional information regarding known, existing current environmental conditions and recommendations to comply with the requirements of the Massachusetts Contingency Plan (MCP) are provided in Section 4.0 – Environmental Considerations and Recommendations.

### 2.4 Existing Flood Issues

The City of Peabody has suffered from recurring flooding events since the 1950's, with the most significant flooding occurring downtown in Peabody Square. Significant floods occurred in 1954, 1968, 1979, 1987, 1996 and 2006. In the past, flooding was largely attributed to post-WWII development and decreased discharge capacity of watercourses in downtown Peabody. However, flooding events have become more frequent with climate change. As noted in the 2008 Preliminary Design of Flood Mitigation Facilities for Peabody Square Area Report, developed for the City, Peabody experienced flooding in October 1996, June 1998, March 2001, April 2004, and May 2006. Three of these events were declared Federal Disasters and caused significant impacts to public safety and public health, substantial property damage, and widespread economic losses. Major transportation arterials that connect to I-95 and MA Routes 128 and 114 as well as commercial rail service were closed for several days. The May 2006 event alone caused the following significant impacts:

- The City's main fire station and police department were isolated by floodwaters for several days. FEMA estimated the cost of this impact at \$1.4 million.
- Emergency responses during the flooding cost the City approximately \$360,000.
- FEMA estimated the loss of associated with road closures, delays, and detours cost \$4.2 million.
- FEMA insurance claims were paid to home and business owners to a total of more than \$4.6 million.

The City also experienced significant flooding in March 2010, October 2011 and December 2014 from short duration and intense rain events.

Flooding in the project area is largely due to high flows in the North River Canal caused by precipitation in the upgradient watersheds of Procter Brook and the North River (Metcalf & Eddy-AECOM, 2008). Precipitation events are projected to be more extreme due to climate change, which would exacerbate riverine flooding in the project area. Currently tidal influences at Mean Higher High Water (MHHW) extend approximately 230 feet upstream of Howley Street (Metcalf & Eddy-AECOM, 2008). Sea level rise is expected to extend tidal influences further upstream into the project area.

The flood events negatively impact area businesses and make it difficult for Fire and Police Department staff to respond to emergencies.

### 3.0 SUBSURFACE INVESTIGATION ACTIVITIES

Weston & Sampson explored subsurface conditions in the project area by overseeing the advancement of six (6) borings (B-1 through B-6) and six (6) test pits (TP-1 through TP-6) between November 5 and 9, 2018. The borings extended to depths of up to 22 feet below grade. The test pit excavations were terminated due to groundwater seepage at depths ranging from 5.6 to 6.8 feet. The approximate exploration locations are shown on Figure 2.

New England Boring Contractors (NEBC) of Derry, New Hampshire advanced the borings using an ATV or truck-mounted drill rig and drive and wash drilling methods. Standard penetration tests (SPTs) were conducted at 2-foot to 5-foot intervals using a standard 24-inch long by 1-3/8-inch inside diameter (2-inch outside diameter) split spoon sampler driven by blows from a 140-pound safety hammer falling 30 inches. Following completion of drilling, the borings were backfilled with soil cuttings.

NEBC excavated the test pits along the back of the existing canal wall using a Kubota U17 excavator with a toothed bucket. The test pits were backfilled with the excavated soil upon completion.

Weston & Sampson geotechnical engineering staff monitored drilling and test pit activities in the field and prepared logs for each boring. A Weston & Sampson structural engineer was also onsite to observe the structural characteristics of the back of the canal wall during test pit activities. Weston & Sampson environmental staff was on site to collect the representative soil samples for disposal characterization data to support the potential excavation and off-site disposal of soil associated with future repairs to the canal wall and construction of the Riverwalk. Boring and test pit logs from the 2018 explorations are included in Appendix D.

A description of the subsurface conditions based on the 2002 borings by GSI and the 2007 and 2018 borings by Weston & Sampson is provided below. Refer to Table 2 – Summary of Subsurface Conditions for a summary of the explorations. The conditions of the existing canal wall observed in the test pits are also summarized in Table 2.

#### 3.1 Subsurface Conditions

Subsurface conditions encountered in the explorations generally consisted of FILL overlying native SAND and SILT to the depths explored. ORGANIC SOILS were observed below the fill in six of the sixteen borings. The major soil groups encountered are described below, in general order of their occurrence with depth. Descriptions of the soils encountered are also included in the attached exploration logs. Variations may occur and should be expected outside of the exploration locations.

Fill: Very loose to very dense FILL (or probable fill) was encountered below surface materials (i.e. topsoil, bare earth, asphalt concrete pavement, or concrete) in all explorations except WS-3. The fill extended to depths ranging from about 4 to 15 feet, and generally consisted of fine to coarse sand with varying amounts of silt, gravel, organic matter, and debris including brick, glass, wood, asphalt, metal, and weathered mortar. Cobbles and boulders up to 28 inches in diameter were observed within the fill in test pits TP-2, TP-3, TP-5, and TP-6. Each of the test pits terminated within the fill.

Native soils: Loose to medium dense or very soft to medium stiff ORGANIC SOILS was encountered below the fill in borings B-1, B-3 through B-6, and WS-2. The organic soils extended to depths ranging from about 8 to 14 feet below existing grade.

Native SAND was encountered below the surface materials, fill, or organic soils in all borings. The sand was fine to coarse-grained or fine-grained, and contained varying amounts of silt and gravel. The sand



was generally described as medium dense to dense, except in borings advanced at 13 Wallis Street, where most of the sand samples were described as loose to medium dense. Roller bit grinding was noted within the sand in some borings, which may be indicative of the presence of cobbles and/or boulders. Medium stiff to hard SILT was encountered below or interlayered with the sand in borings WS-2, WS-3, WS-4, B-3, and B-5. Each of the borings terminated within the sand or silt.

*Refusal:* Borings B-1(GSI) and B-4(GSI) encountered auger refusal at depths of 40 feet and 32 feet, respectively. Rock coring was not performed, and therefore refusal could have been on cobbles, boulders, and bedrock.

### 3.2 Groundwater

Logs for borings B-1(GSI) through B-6(GSI) report groundwater depths ranging from 8 feet to 10.5 feet at the completion of drilling. Groundwater depths were not measured in borings WS-1 through WS-4 or B-1 through B-6 due to the drilling method (drive and wash) which introduces water into the borehole during drilling. Groundwater seepage was observed at depths ranging from about 4.6 to 6.7 feet below grade in TP-1 through TP-6. Groundwater levels are expected to be influenced by the water level in the North River Canal and may fluctuate due to local and regional factors including, but not limited to, precipitation events, seasonal changes, and periods of wet or dry weather.

### 3.3 Geotechnical Laboratory Testing

Select soil samples from the 2018 explorations were submitted to GeoTesting Express of Acton, Massachusetts for grain size analysis to confirm field classification and estimate engineering properties. Geotechnical Laboratory analytical results are included on the boring logs and in a copy is provided in Appendix E.

### 3.4 Conditions of Existing Canal Wall

Overall site conditions remained relatively unchanged from the 2017 structural evaluation report that was completed by Weston & Sampson and provided in *Appendix A*, other than an increase in overgrown vegetation. It was also noted that the north wall was at a lower elevation than the south wall for about half the wall length.

The six (6) exploratory test pits described above (TP-1 through TP-6) were excavated in order to determine the condition of the wall behind the canal, and to determine if any footings or foundations belong to the wall. Three (3) test pits (TP-1 through TP-3) were completed on the 24 Caller Street property, and the remaining three (3) test pits (TP-4 through TP-6) were completed on the 21 Caller Street Property. Locations of test pits can be found in *Figure 2*

At the originally proposed location of TP-1, the wall was in poor condition and a communal decision was made between engineers and the excavator operator to move about 12 feet eastward to a location of more stable wall, so as not to collapse the wall into the river during excavation. Test pit TP-1 revealed a rock wall consisting of large boulders about 34 inches in thickness. The canal-side face of the wall segment showed grout between each boulder. However, no grouted surfaces were found at the back of the wall. No visible footings or foundation were discovered after 6 feet of excavation. The top of wall was 3 feet 4 inches above the river bed, with 4 inches of water above the river bed.

At test pit TP-2, a concrete wall exists in good condition. At the test pit location, the wall thickness changes from 21 inches to 17 inches at a 90-degree bend. No structural foundation was discovered after 5 feet of excavation, however large rocks of similar size as at test pit TP-1 were encountered in test

pit TP-2 at the base of the wall and visible from the canal-side face of the wall. The top of wall was 6 feet 8 inches above the river bed with 1 foot 8-inches of water above the river bed.

Test pit TP-3 was excavated at a concrete wall segment in good shape and 21 inches thick. No footing was encountered after roughly six feet of excavation. The top of wall was 6 feet 4 inches to the river bed, with 1 foot 1-inch of water above the river bed.

The wall at test pit TP-4 was a stone wall with mortar on the front face and the excavated rear face. The wall was 16 inches thick. No visible footing was found after 6 feet of excavation. A hard and irregular shaped surface was encountered by probing with a metal rod about a foot below the test pit. The top of wall was 6 feet 4 inches above the river bed with 4 inches of water above the river bed.

The wall at test pit TP-5 consisted of roughly 20-inch thick stacked rocks. No visible grout or mortar was encountered on either side of the wall. No footing was encountered after 6 feet of excavation. The top of wall was 6 feet above the river bed with 2 feet of water above the river bed.

No wall was encountered during excavation at test pit TP-6. Small rocks were visible along the sloped shore line, with larger rocks at and just above the water level.

### 3.5 Disposal Characterization Sampling and Analysis

To support the potential excavation and off-site disposal of soil associated with future repairs to the canal wall and construction of the Riverwalk, Weston & Sampson collected one (1) composite soil sample (TP-5) from 5 to 6 feet below ground surface (bgs) from the test pit advanced on the 21 Caller Street property on November 6, 2018. The owners of 166R Main Street and 24 Caller Street would not allow Weston & Sampson to collect samples for environmental analyses.

The sample from the 21 Caller Street property was submitted for disposal characterization parameters pursuant to the Massachusetts Department of Environmental Protection (DEP) Policy #COMM-97-001, *Reuse and Disposal of Contaminated Soil at Massachusetts Landfill*, including: total petroleum hydrocarbons (TPH); Resource Recovery Act (RCRA) 8 metals (arsenic, barium, cadmium, chromium, lead, mercury, selenium and silver); semi-volatile organic compounds (SVOCs); polychlorinated biphenyls (PCBs); pH; ignitability; specific conductivity; and reactivity. The sample was later analyzed for speciated chromium and Toxicity Characteristic Leaching Procedure (TCLP) metals analysis. A grab soil sample was submitted for laboratory analysis for volatile organic compounds (VOCs) from the test pit.

The results of the disposal characterization analyses are presented in **Table 3**. The results were compared to the COMM-97-001 requirements for reuse at Massachusetts lined and unlined landfills. As shown in **Table 3**, soil analytical results indicate concentrations do not exceed the RCS-1 thresholds or the COMM-97-001 Disposal/Reuse levels for In-State Lined and Unlined Landfills and were consistent with the analytical results for the soils collected in the 0-5 ft bgs interval in 2017. However, based on the history of the Site and the contaminant concentrations detected, surplus soils generated at 21 Caller Street as part of the Riverwalk project will likely be required to be managed and disposed of appropriately in accordance with the Massachusetts Contingency Plan (MCP).

A copy of the laboratory analytical report is included as **Appendix F**.

## 4.0 ENVIRONMENTAL CONSIDERATIONS AND RECOMMENDATIONS

The City is considering property acquisition or easements on private property as part of the repair / replacement options for the southern canal wall and construction of the Riverwalk. As the City is aware, there is known or suspected soil contamination along the proposed area of these activities that will need to be addressed. Most of the area was formerly a tannery and it has known or potential environmental impacts, including several previously identified Disposal Sites as defined by the MCP; 310 CMR 40.0000.

In 2017, in support of the City of Peabody's desire to construct the Riverwalk along the North River Corridor, limited subsurface investigations were performed as part of a multi-parcel limited environmental assessment on the 21 and 24 Caller Street, 18 and 20 Howley Street, and 13 Wallis Street properties. Each assessment evaluated the top 5 feet of soils in an approximate 10-foot wide strip of land abutting the south side of the North River in Peabody, Massachusetts. Copies of the 2017 Limited Subsurface Investigation Reports are included as Appendix C. Analysis of soil samples identified concentrations of metals (i.e. antimony, arsenic, barium, trivalent chromium, unspeciated chromium (hexavalent), lead, and zinc) and polycyclic aromatic hydrocarbons (PAHs) (i.e. benzo(a)anthracene, benzo(a)pyrene, benzo(b)fluoranthene, dibenz(a,h)anthracene and phenanthrene) above the applicable MCP RCS-1 thresholds and Method 1 S-1/GW-2 and S-1/GW-3 standards. Therefore, excess soils generated during construction activities associated with the construction of the wall will be required to be managed and disposed of appropriately in accordance with the MCP.

A summary of the estimated soil transportation and disposal cost estimates associated with each property evaluated as part of the wall alternative analysis is provided in Table 4 – Soil Transportation and Disposal Cost Estimate Summary. These cost estimates do not include any soils that may need to be removed from the properties associated with the future construction of the proposed Riverwalk, etc., as the preliminary design of the Riverwalk has not been completed at this time.

### 4.1 MCP Regulatory Considerations

#### 4.1.1 13 Wallis Street

The property located at 13 Wallis Street is not listed as Disposal Site by MassDEP; however, it has a long, industrial history primarily in tannery operations. Currently, a US Post Office occupies the northwestern corner of the property and the remainder of the property is used to store miscellaneous construction equipment.

A subsurface investigation conducted in 2009 indicated the presence of fill material containing arsenic, chromium, and lead at concentrations in excess of the MassDEP Reportable Concentrations (RCs) for S-1 soil (RCS-1) at a depth of 0-5 feet below ground surface. Several additional metals and PCBs were detected at concentrations below the applicable MassDEP RCS-1 thresholds in shallow soil. PAHs were detected below the RCS-1 thresholds in deeper soil (5-10 feet below ground surface); however, PAHs were not analyzed in the 0-5 foot depth interval. Data collected during the 2009 sampling event is insufficient in that only two (2) boring locations were investigated, and no shallow soil was analyzed for PAHs. The concentrations of arsenic, chromium, and lead detected during the 2009 subsurface investigation above the RCS-1 thresholds were not reported to the MassDEP by the property owner.

The contaminant concentrations reported during Weston & Sampson's limited subsurface investigation in 2017 indicated that:



- A reportable condition exists at the Site due to the presence of arsenic, chromium, lead, and PAHs at concentrations above the RCS-1;
- The City is not currently obligated to report the RCS-1 exceedances to MassDEP, however, If the City takes ownership of the Site, the City will be responsible for reporting the release to MassDEP within 120 days of the property transfer;
- In general, contaminants in the 0-2 feet bgs depth interval tend to be similar to the concentrations of contaminants in soils in the 2-5 ft bgs depth interval;
- Excavation will require soil management under the MCP;
- The contaminated media (soil) will require disposal at an appropriate facility and documentation by a Licensed Site Professional (LSP); and
- The soil did not fail the leachability test and does not require disposal at a RCRA facility.

Prior to the start of construction at the Site, the detected release of PAHs, lead, and arsenic (detected during a previous investigation) will require reporting to the MassDEP, and construction will require management under a Release Abatement Measure (RAM). During construction of the preferred wall alternative selected by the City, soils will likely be excavated and will be required to be disposed of at a licensed facility.

Based upon currently available information, soils from 13 Wallis Street meet the disposal requirements for in-state unlined and lined landfills. However, Weston & Sampson has assumed that because each wall repair option at 13 Wallis Street generates less than 500 cubic yards of soils, all soils will be managed similarly across all properties as the cost difference among in-state and out of state non-hazardous disposal facilities does not exceed the cost to manage the soils separately. Out-of-state (non-hazardous) soil transportation and disposal currently costs approximately \$65 / ton.

Potential MCP regulatory obligations to the City associated with the repair / replacement of the southern canal wall along the corridor at the 13 Wallis Street Property may include the following:

- MCP compliance costs for soil disturbance / construction activities ~ \$40,000
  - Release Abatement Measure Plan (RAM) Plan, including Health and Safety Plan (HASP & Soil Management Plan (SMP)
  - RAM Status Report
  - Method 3 Risk Assessment for Riverwalk Area
  - Permanent Solutions Statement PSS (assumes no AUL based on existing data)
  - RAM Completion Report
  - Soil Management & Bills of Lading (BOLs)
- Construction Administration, Coordination & Oversight ~ \$5,000 - \$10,000

Estimated TOTAL = ~ \$45,000 - \$50,000 (not including release notification to MassDEP, soil transportation and disposal, wall repair design plans, regulatory permitting, bids and specifications or construction costs).

#### 4.1.2 24 Caller Street

The property located at 24 Caller Street has a documented history of environmental releases and is regulated under the MCP. In 2000, 24 Caller Street [Release Tracking Number (RTN) 3-18180] was closed under the MCP with an Activity and Use Limitation (AUL) [i.e., an A-3 Response Action Outcome (RAO) and AUL].

The AUL is located on the northwestern portion of the parcel and is approximately 15,000 square feet of

the 42,776-square feet total parcel area. The AUL restricts any activity including, but not limited to excavation, which is likely to disturb contaminated soil located at 1 to 8 feet below grade. Residential use and any other use at which a child's presence is likely [i.e., an educational facility/school (with the exception of adult education), a daycare/nursery, a recreational facility (such as a park or athletic fields, etc.)] is also prohibited. The portion of the 24 Caller Street parcel that the City is interested in redeveloping into the Riverwalk is also within the AUL area.

No files are available on-line from MassDEP for RTN 3-18180. A copy of the RAO Statement for the 24 Caller Street property (RTN 3-18180), dated August 4, 2000, was provided by the City. The RAO report is incomplete and did not include relevant data tables, appendices and/or referenced historical reports. A file review was therefore completed at the MassDEP for RTN 3-18180 on December 8, 2016. Contaminants of concern include metals (lead / chromium / cadmium / arsenic), PAHs and VOCs, and to a lesser extent polychlorinated biphenyls (PCBs). In addition, the site file for RTN 3-18180 indicated that a historic 'landfill' was identified in the northeast portion of parcel.

Given that the property has continued to operate as a barrel reconditioner in the approximately 19 years since regulatory closure and the data gaps from the previous RAO, a Limited Subsurface Site Investigation was conducted by Weston & Sampson on behalf of the City to evaluate the quality of the surficial and near surficial soils. The investigation was confined to the area of the proposed Riverwalk only.

In summary, the data that was generated during the 2017 limited subsurface investigation completed by Weston & Sampson is generally consistent with the limited findings presented in the RAO report for RTN 3-18180. Based on the data collected, no new reportable conditions under the MCP were encountered. Because the Site is fenced with limited access, no Imminent Hazard (IH) condition was discovered. However, the concentrations indicate that:

- In general, contaminants in the 0-2 feet bgs depth interval tend to be greater than the concentrations of contaminants in soils in the 2-5 ft bgs depth interval;
- Excavation will require soil management under the MCP;
- The contaminated media (soil) will require disposal at an appropriate facility and documentation by a LSP; and
- The soil did not fail the leachability test and does not require disposal at a RCRA or hazardous waste disposal facility.

Future Site use for the property as a passive recreational facility will have a different exposure scenario than current site conditions, therefore a Method 3 Risk Characterization for the property will be needed to evaluate risks under the new conditions and with new (i.e., post-construction) exposure point concentrations. Specifically, recreational use (such as a park or athletic fields) and/or any other use at which a child's presence is likely, are currently prohibited at the Site, in accordance with the AUL.

In addition, any activity including, but not limited to, excavation which is likely to disturb contaminated soil located at 1 to 8 feet bgs associated with underground utility and/or construction work, without prior development and implementation of a Soil Management Plan (SMP) and a Health and Safety Plan (HASP) is also prohibited. The contaminated soil located at 1 to 8 feet below surface grade must remain at depth and may not be relocated, unless such activity is first evaluated by a Licensed Site Professional (LSP) who renders an Opinion which states that such activity poses no greater risk of harm to health, safety, public welfare, or the environment and ensures that a condition of No Significant Risk is maintained.

.....

In summary, to repair the wall located at 24 Caller Street and construct the Riverwalk, soils will likely be excavated, and will need to be properly managed and disposed of at a licensed facility. Based upon currently available information, soils from 24 Caller Street must be disposed of at an out of state non-hazardous disposal facilities. Out-of-state (non-hazardous) soil transportation and disposal costs are currently estimated at approximately \$65 / ton.

Following removal of impacted materials, soil sampling will be required to evaluate remaining conditions and associated risk under the MCP. A new risk characterization will be required for the property. A geotextile membrane barrier may also be required to separate impacted fill as part of the risk management strategy. A revised Activity and Use Limitation (AUL) will likely also be required to document and manage site risks.

Potential regulatory obligations to the City associated with the repair / replacement of the southern canal wall along the corridor at the 24 Caller Street Property may include the following:

- MCP compliance costs for soil disturbance / construction activities ~ \$55,000
  - RAM Plan, including HASP & SMP
  - RAM Status Report
  - Additional sampling to support new risk characterization
  - Method 3 Risk Assessment
  - Revised PSS and AUL (and associated land survey)
  - RAM Completion Report
  - Soil Management & Bills of Lading (BOLs)
- Construction Administration, Coordination & Oversight ~ \$5,000 - \$10,000

Estimated TOTAL = ~ \$60,000 - \$65,000 (not including soil transportation and disposal, wall repair design plans, regulatory permitting, bids and specifications or construction costs).

As the City is interested in purchasing the entire 24 Caller Street parcel, a comprehensive Phase I/II Environmental Site Assessment (ESA) is recommended prior to the City taking title to the property in order to: 1) address data gaps; 2) to support the proposed reuse and evaluate exposure risks under non-industrial/commercial use; 3) to provide liability protection to the City; and 4) to evaluate regulatory obligations and costs to proceed with redevelopment of the property as a passive recreational facility. As detailed above, the RAO report for RTN 3-18180 was incomplete and did not include copies of relevant data / tables, appendices and/or referenced previous reports. Based upon our review, several data gaps exist at the property based upon the lack of information provided in the RAO report as well as the lack of any recent data relevant to the existing conditions at parcel based upon the barrel reclamation operations that have continued to be conducted at property since 2000.

#### 4.1.3 21 Caller Street

The 21 Caller Street property has a documented history of releases to the environment and is regulated under the MCP. 21 Caller Street [Release Tracking Number (RTN) 3-0577] is closed with a Permanent Solution Statement with Conditions that includes an AUL, which restricts any activity or uses that involve the excavation, removal and/or disturbance of soils greater than 3 feet below grade. Additionally, the AUL prohibits the use of the property. The AUL is applicable to the entire parcel but there has been limited assessment in the area of interest to the City along the canal.

Contaminants of concern are metals (i.e., cadmium, chromium and lead); however limited concentrations of Polycyclic Aromatic Hydrocarbons (PAHs), Volatile Organic Compounds (VOCs)



and/or Extractable Petroleum Hydrocarbons (EPHs) which have historically been detected at the property. Historical fill containing ash, cinders, brick, buffing dust, and/or leather scraps was also historically observed at approximately 1-8 feet below ground surface (bgs) across the property.

The data collected in 2017 was generally consistent with the findings in the PSS report filed for the Site under RTN 3-0577:

- In general, contaminant concentrations are similar in the 0-1 and 2-5 feet depth intervals, with the exception of 2-5 feet bgs soils at SP-3, which contains elevated concentrations of arsenic and lead;
- Excavation will require soil management under the MCP; and
- Surplus soil will require disposal at an appropriate facility and documentation by a Licensed Site Professional (LSP).

The Method 3 Risk Characterization presented in the PSS for the Site includes exposure scenarios consistent with the City's planned future for the Riverwalk. Specifically, "use of the [Site] without limitation to pedestrian and/or vehicle traffic" is permitted under the AUL. Furthermore, given that the 2017 and newly collected data is consistent with the previous data and findings of the PSS, an updated Method 3 Risk Characterization for the proposed Riverwalk (i.e. easement) area will not likely be necessary. However, activities inconsistent with the AUL including "excavation, removal, and/or disturbance of subsurface soil greater than three (3) feet below ground surface" are likely to occur during wall repair and redevelopment and will require a Release Abatement Measure (RAM) Plan to be filed with MassDEP, along with a Soil Management Plan (SMP) and Health and Safety Plan (HASP). A new risk characterization will not likely be required for the Riverwalk area and redevelopment is unlikely to require a separate AUL or PSS.

In summary, in order to implement a wall repair alternative, soils will likely be excavated and require disposal at an appropriate facility. Based upon currently available disposal characterization data collected from the proposed Riverwalk area of the property in 2017 and 2018, soils concentrations were less than RCS-1 and Comm-97 criteria for in-state unlined and lined landfills. However, Weston & Sampson has assumed that because each wall repair option at 21 Caller Street generates significantly less than 500 cubic yards of soils, all soils will be managed similarly across all properties as the cost difference among in-state and out of state non-hazardous disposal facilities does not exceed the cost to manage the soils separately. Out-of-state (non-hazardous) soil transportation and disposal currently costs approximately \$65 / ton.

Potential regulatory obligations to the City associated with the repair / replacement of the southern canal wall along the corridor at the 21 Caller Street Property may include the following:

- MCP compliance costs for soil disturbance / construction activities ~ \$30,000
  - Release Abatement Measure Plan (RAM) Plan, including HASP & SMP
  - RAM Status Report
  - RAM Completion Report
  - Soil Management & Bills of Lading (BOLs)
- Construction Administration, Coordination & Oversight ~ \$5,000 - \$10,000

---

Estimated TOTAL = ~ \$35,000 - \$40,000 (not including soil transportation and disposal, wall repair design plans, regulatory permitting, bids and specifications or construction costs).

#### 4.1.4 18 Howley Street

The property located at 18 Howley Street has a documented history of environmental releases and is regulated under the MCP. 18 Howley Street, identified by MassDEP as RTN 3-0577, was closed under the MCP in 2013 with a B-2 Response Action Outcome (RAO) and Activity and Use Limitation (AUL) [i.e., a Permanent Solution Statement with Conditions].

The AUL restricts the use of the property as a residence, school, daycare, nursery recreational area (e.g., park or athletic field) and/or any other use in which a child's presence (other than incidental). The AUL also restricts the use of the property for growing produce for human consumption as well as any long-term (greater than 1 month) activity at the property that is likely to result in the excavation, relocation and/or removal of soils, unless such activity is first evaluated by an LSP. The AUL is applicable to the entire parcel, and therefore includes the Site.

The primary contaminants of concern are metals (i.e., arsenic, chromium and lead), PAHs, extractable petroleum hydrocarbons (EPHs), dioxins, and polychlorinated biphenyls (PCBs). Historical fill containing ash and/or coal has also been observed. Contamination appears to be limited to the top 8 feet of soil across the property.

The data collected by Weston & Sampson during the limited subsurface investigations in 2017 is generally consistent with the limited findings in the RAO report for RTN 3-0577. Based on the data collected, no new reportable conditions under the MCP were encountered. Concentrations indicate that:

- In general, contaminants in the 0-1 feet bgs depth interval tend to be greater than the concentrations of contaminants in soils in the 2-5 ft bgs depth interval;
- Excavation will require soil management under the MCP;
- The contaminated media (soil) will require disposal at an appropriate facility and documentation by an LSP; and
- The soil did not fail the leachability test and does not require disposal at a RCRA (hazardous waste) facility.

Future Site use for the Riverwalk trail will have a different exposure scenario than current site conditions; therefore, a Method 3 Risk Characterization for the proposed Riverwalk (i.e. easement) area will need to evaluate risks under the new conditions and with new (i.e., post-construction) exposure point concentrations. Specifically, recreational use (such as a park or athletic fields) and/or any other use at which a child's presence is likely, are currently prohibited at the Site, in accordance with the AUL. Likewise, any long-term (greater than 1 month) activity at the property that is likely to result in the excavation, relocation and/or removal of soils, unless such activity is first evaluated by an LSP.

In summary, during construction of the preferred wall alternative, soils will likely be excavated and disposed of at a licensed facility. Based upon currently available information, soils from 18 Howley Street must be disposed of at an out of state non-hazardous disposal facilities. Out-of-state (non-hazardous) soil transportation and disposal costs are currently estimated at approximately \$65 / ton.

Following removal of impacted fill, soil sampling will be required to evaluate remaining conditions and associated risk. A new risk characterization will be required for the Riverwalk area. A geotextile membrane barrier may also be required to separate impacted fill as part of the risk management strategy. A separate AUL may also be required to document and manage site risks along the Riverwalk corridor area.

Potential regulatory obligations to the City associated with the repair / replacement of the southern canal wall along the corridor at the 18 Howley Street Property may include the following:

- MCP compliance costs for soil disturbance / construction activities ~ \$55,000
  - Release Abatement Measure Plan (RAM) Plan, including HASP & SMP
  - RAM Status Report
  - Additional sampling to support new risk characterization
  - Method 3 Risk Assessment for Riverwalk Area
  - Revised PSS and AUL for Riverwalk Area (and associated land survey)
  - RAM Completion Report
  - Soil Management & Bills of Lading (BOLs)
- Construction Administration, Coordination & Oversight ~ \$5,000 - \$10,000

Estimated TOTAL = ~ \$60,000 - \$65,000 (not including soil transportation and disposal, wall repair design plans, regulatory permitting, bids and specifications or construction costs).

#### 4.1.5 166R Main Street

The property located at 166R Main Street has a documented history of environmental releases and is regulated under the MCP. 166R Main Street, identified by MassDEP as RTN 3-1444 and RTN 3-4322.

RTN 3-4322 was closed under the MCP in 1997 with a A-2 RAO [i.e., a Permanent Solution Statement].

RTN 3-1444 was closed under the MCP in 2007 with an A-3 RAO and AUL [i.e. a Permanent Solution Statement with Conditions]. The AUL restricts the use of the property for single family residential use or for growing of produce for human consumption. The AUL also restricts activity at the property that is likely to cause physical or chemical deterioration, breakage, or damage to the pavement or building foundations, unless such activity is first evaluated by an LSP. The AUL is applicable to the entire parcel. The primary contaminants of concern at the 166R Main Street property are metals (i.e., arsenic, chromium and lead), PAHs, EPH, and VHP. Historical fill has also been observed in the top 8 to 10 feet of soil.

The property owner did not provide the City access to allow Weston & Sampson to collect samples for disposal characterization from the area of the proposed wall improvement activities and proposed Riverwalk. Therefore, for cost-estimation purposes, based upon the limited historical data available for the property and the data collected to date from the adjacent properties in the area, it has been assumed that soils generated during construction of the preferred wall alternative at 166R Main Street will be required to be disposed of at an out of state non-hazardous disposal facilities. Out-of-state (non-hazardous) soil transportation and disposal costs are currently estimated at approximately \$65 / ton.

Future use for the Riverwalk trail will have a different exposure scenario than current site conditions; therefore, a Method 3 Risk Characterization for the proposed Riverwalk (i.e. easement) area will need to evaluate risks under the new conditions and with new (i.e., post-construction) exposure point concentrations.

A geotextile membrane barrier may also be required to separate impacted fill as part of the risk management strategy. A separate AUL may also be required to document and manage site risks along the Riverwalk corridor area.



Potential regulatory obligations to the City associated with the repair / replacement of the southern canal wall along the corridor at the 166R Main Street Property may include the following:

- MCP compliance costs for soil disturbance / construction activities ~ \$55,000
  - Release Abatement Measure Plan (RAM) Plan, including HASP & SMP
  - RAM Status Report
  - Additional sampling to support new risk characterization
  - Method 3 Risk Assessment for Riverwalk Area
  - Revised PSS and AUL for Riverwalk Area (and associated land survey)
  - RAM Completion Report
  - Soil Management & Bills of Lading (BOLs)
- Construction Administration, Coordination & Oversight ~ \$5,000 - \$10,000

---

Estimated TOTAL = ~ \$60,000 - \$65,000 (not including soil transportation and disposal, wall repair design plans, regulatory permitting, bids and specifications or construction costs).

#### 4.2 MCP Environmental Regulatory Summary and Recommendations

The properties that will be impacted as part of the repair / replacement alternatives for the south wall of the North River Canal are known or suspected to be contaminated. Construction activities will require management of soils in accordance with the MCP and under a RAM Plan. Excess soils will be required to be disposed of at a licensed disposal facility. Given the approximate quantities to be generated at each individual property locations for the repairs of the wall, Weston & Sampson has assumed that all soils will be managed similarly across all properties as the cost difference among in-state and out of state non-hazardous disposal facilities does not exceed the cost to manage the soils separately.

Additional MCP regulatory compliance requirements may also include: RAM Status Reports, additional sampling to support new risk characterization for Riverwalk area, Method 3 Risk Assessments for Riverwalk Area; Revised PSSs and AULs for Riverwalk Area (and associated land surveys); RAM Completion Reports, Soil Management & Bills of Lading (BOLs); and Construction Administration, Coordination & Oversight. In total, MCP regulatory compliance requirements are currently estimated at approximately \$260,000 - \$285,000. Cost do not include out-of-state (non-hazardous) transportation and disposal cost for soils that need to be removed as part of the repairs to the wall, as these costs have been included in the wall alternative cost estimates provided in *Appendix I*.

## 5.0 GEOTECHNICAL DESIGN AND CONSTRUCTION RECOMMENDATIONS

The following sections provide preliminary geotechnical design considerations and recommendations for site design, and for evaluation and selection of preferred wall replacement alternative(s). Weston & Sampson should be contacted to provide specific geotechnical design and construction recommendations during final design. Additional information on the use of these geotechnical recommendations is provided in the document titled "Important Information about this Geotechnical Engineering Report" by Geoprofessional Business Association (GBA), Inc., included as Appendix G.

### 5.1 Existing Fill and Organics

Undocumented fill and organic soils were encountered to depths of up to 15 feet below grade, with organic soil thicknesses ranging from 1.5 to 8 ft. at locations explored. These materials are not suitable for support of structures due to the risk of differential settlement from variable rates of compression/decomposition of these materials. Fill and organics should be removed from within the "zone-of-influence" (ZOI) beneath new foundations and other rigid structures sensitive to settlement. The ZOI is defined by planes extending horizontally away from the bottom edge of the structure a distance of two feet, then down and away at a 1H:1V (horizontal:vertical) slope to the intersection with suitable native soils. The resulting excavation should be backfilled with compacted Structural Fill.

Placement of new fill above existing site grades will result in settlement due to compression of underlying existing fill and organic soils. The amount of settlement will vary with the load increase and the thickness and composition of existing fill and organics. Over-excavation and replacement of the unsuitable materials, the use of lightweight fill materials, or design for settlement should be considered if grade changes are proposed.

### 5.2 Retaining Walls

Concrete cantilever walls or stone masonry walls can be supported on a minimum 12-inch thick bedding layer of compacted Structural Fill overlying native, inorganic sand and/or silt following removal of existing fill and organic soils. The retaining wall bedding layer should extend at least 18 inches horizontally past the edges of the wall foundation or bottom blocks. Foundations should extend at least 4 feet below the nearest ground surface exposed to freezing.

Retaining wall foundations bearing on subgrades prepared as described herein can be designed using an allowable bearing pressure of 2000 psf for foundations constructed on loose sands such as at 13 Wallis Street, and 4000 psf for foundations constructed on medium dense (or denser) sand or medium stiff (or stiffer) silt or structural fill.

#### 5.2.1 Lateral Pressures

Design lateral pressures should consider appropriate loading conditions including earth pressures, hydrostatic, wind, seismic, and surcharge loads such as sloped backfill, structures and adjacent traffic as appropriate. The design lateral pressures should be calculated by adding unbalanced earth and water pressures, and surcharge pressures from structures near the proposed wall.

Lateral earth pressures for design of new retaining walls may be computed using the preliminary soil parameters provided in the table below:

## Preliminary Soil Design Parameters for Retaining Walls

Parameter	Values for			
	Existing Fill	Organics	Native Sand and Silt	Compacted Backfill
Angle of Internal Friction, $\phi$	28°	26°	30°	34°
Total Unit Weight, $\gamma$ (pounds per cubic foot)	125	115	125	130
Buoyant Unit Weight, $\gamma'$ (pounds per cubic foot)	62.6	52.6	62.6	67.6

Groundwater level at the site should be assumed at ground surface. In addition, we recommend a minimum 150 psf lateral surcharge pressure be assumed over the full height of the wall, intended to account for vertical areal surcharge pressures at the top of the wall up to 300 psf. Additional lateral pressures equal to 0.5 times the additional surcharge pressures should be added to sections of wall where surcharge pressures exceed 300 psf.

Resistance to lateral loads should be calculated using a base friction coefficient of 0.35. For resistance to lateral loading we recommend a minimum factor of safety of 1.5 when using sliding friction alone. A larger magnitude of movement is required to engage passive resistance than sliding friction. Therefore, a minimum factor of safety of 2.0 is recommended when using passive pressure in addition to friction to resist lateral loads. Passive earth pressures should be ignored for a depth of 4 feet below bottom of canal.

Footings, floor slabs, and other improvements located above and behind retaining walls (including footings for upper walls in tiered retaining wall configurations) and within a zone defined by a plane extending upward at 1H:1V from the back of the bottom of the wall will increase lateral pressures on the wall. We should be consulted if footings or surcharges are located within this zone. The global slope stability of the proposed retaining walls will have to be confirmed once design progresses.

### 5.2.2 Seismic Considerations

Seismic site class is determined in accordance with the International Building Code (IBC) as adapted by the Massachusetts State Building Code using a weighted average of SPT blow counts in the upper 100 feet of soil at a site. Based on the soil types and consistencies encountered in the boring (to the depths explored), we recommend that new canal walls be designed using parameters presented in the table below:

Seismic Design Parameters

Design Parameter	Recommended Value
Site Class	E
$S_s$	0.240 g
$S_1$	0.073 g
$F_a$ [IBC Table 1613.5.3(1)]	2.5
$F_v$ [IBC Table 1613.5.3(2)]	3.5



Loose, potentially liquefiable native sands were encountered in borings WS-1, B-1(GSI) through B-3(GSI), B-5(GSI) and B-6(GSI) at 13 Wallis Street. Soil liquefaction describes a phenomenon in which saturated granular soils lose their strength during earthquake conditions, causing sinkholes, or deformation and/or settlement of structures they support. Liquefaction potential depends on the soil density, fines content, groundwater depth, and the magnitude of ground movements during seismic events. Additional borings and lab testing should be conducted in this area during final design to further evaluate the potential for liquefaction. Mitigation measures such as over-excavation and replacement may be necessary to address potential liquefaction.

### 5.3 Construction Considerations

Existing structures, pavements, curbing, vegetation, topsoil, tree roots greater than 1-inch in diameter, and surface debris should be removed from within the limits of construction during initial site preparation. The existing fill contains debris, cobbles, and boulders which may interfere with installation of driven wall elements. Pre-trenching may be required to remove these obstructions if a driven wall type is selected (such as soldier pile or sheet pile wall). Any existing utilities within the proposed development areas should be identified and properly removed, re-routed, or evaluated and approved to remain.

Excavations to remove and replace the existing canal walls will extend up to about 10 feet, or deeper where unsuitable soils are present at proposed structure bearing depths. Temporary excavation support will be required where excavations cannot feasibly be open cut, such as locations adjacent to structures and utilities, and where groundwater seepage is present. Groundwater is expected to be approximately equal with the water level in the canal and dewatering of excavations should be anticipated during construction.

Weston & Sampson should be contacted to evaluate exposed subgrades prior to placement of overlying materials and foundation construction.

#### 5.3.1 Fill Materials and Placement

The existing fill at the site contains variable amounts of fines, organics, and debris. The existing fill is not suitable for use as Structural Fill (i.e., support of structures or other settlement sensitive features) but may be suitable for use as backfill in non-structural or landscape areas, provided it can be moisture conditioned and compacted to at least 92 percent maximum dry density as determined by ASTM D1557 (modified proctor).

Structural Fill beneath foundations and other settlement sensitive improvements (or where on-site materials are not available or suitable for re-use) should consist of well graded imported sand and gravel with less than approximately 10 percent fines (such as MassDOT M1.03.0- type B Gravel Borrow or M2.01.7 Dense-graded Crushed Stone). Structural fill should have a maximum particle size of 3 inches and be compacted to at least 95 percent of maximum dry density as determined by ASTM D1557.

Crushed stone shall be wrapped in filter fabric, consisting of a woven geosynthetic with an AOS of #70 to #100 sieve, and a minimum puncture resistance of at least 120 pounds (such as Mirafi FW700 or equivalent).

## 6.0 WALL ALTERNATIVE ANALYSIS

Five wall alternatives are being considered for the repair of the south wall of the North River Canal from Wallis Street to Howley Street. The alternative wall types being considered are:

- Alternative A – Rip Rap Slope
- Alternative B – Vegetative Berm Above Rip Rap Slope
- Alternative C – Sheet Pile Wall
- Alternative D – Cantilever Concrete Retaining Wall
- Alternative E – Stone Masonry Wall

Regardless of the alternative chosen, grades along the river may need to be raised or lowered in order to achieve ADA compliance for the Riverwalk. A new bridge structure will likely be required over Strongwater Brook. The existing Caller Street Bridge creates a design constraint for all alternatives considered. Each alternative has taken into account the need to accommodate the existing river width opening at the Caller Street Bridge. Each alternative will require the handling of contaminated/potentially-contaminated soils to some extent. Easements or property acquisition will be required for each alternative to accommodate the Riverwalk, with some alternatives requiring more property than others. Multiple storm drains exist in the area of the proposed new wall alternatives; these drains will need to be accommodated and accounted for later in the design process. Typical cross sections of each alternative can be seen in *Appendix H*.

Since the north wall is at a lower height elevation than the current south wall for about half of the river length being considered, raising the south wall height would create more flooding on the north side of the river. If additional flood storage is desired, each alternative can be adjusted to allow for river widening in addition to repairing the south wall. All design alternatives propose the new south wall height be constructed to match the existing south wall height.

Each alternative was analyzed for its resilience, durability, environmental impacts, constructability, construction schedule, and cost. The recommended alternative was decided by comparing these five aspects of each design alternative. The engineer's cost estimate for each alternative can be found in *Appendix I*.

The resiliency of each wall alternative was evaluated based on the six design flood-climate change projection scenarios presented in Weston & Sampson's report entitled, *MVP Action Grant: Peabody North River Canal Resilient Wall, Riverwalk and Park – Resilience Evaluation (Resilience Evaluation)*, dated February 2019, and the estimate of the potential benefit in terms of volume of storage and the number of parcels that may be removed from the floodplain without increasing downstream flooding impacts. Fifty-eight parcels or portions of parcels were identified in the study area. The maximum percent of parcels protected for all wall alternatives and the six scenarios ranged from 11% to 60% of the total number of parcels in the study area. A copy of the Resilience Evaluation is provided in Appendix J.

### 6.1 Alternative A – Rip Rap Slope

Alternative A consists of placed rip rap on a slope of 1 vertical to 1.5 horizontal. The rip rap will be placed in a 3-foot thick layer, with diameters ranging from 8 to 24-inches, underlain with a 1-foot layer of bedding stone placed on top of geotextile fabric for permanent erosion control. The rip rap will extend 5-feet into the river bed and 3.5-feet below the river bed to maintain continuity with the slope. This alternative requires the removal of the existing south wall along the entire length in consideration.

Two options are considered for the location of the bottom of the rip rap slope. Option 1 is to set the bottom of the slope at the location of the existing wall which will provide some additional flood storage. Option 2 is to set the bottom of the slope into the river providing no additional flood storage but maintaining the storage the current river width provides.

#### 6.1.1 Resilience

- Option 1 would provide 18 cu. ft./ft. additional flood storage capacity; Option 2 would match current flood storage capacity.
- The surface roughness of the rip rap would decrease flood flow speed.
- Allows flexibility to vary slope along river length to allow more flood storage at key locations.
- In the future, both options can accommodate the future flood elevations by constructing a berm on top of the would-be existing slope, however the north wall height will also need to be increased to not cause increased flooding on the north side. The Riverwalk pathway would need to be located away from the top of slope to allow room for this potential future berm to be constructed. Additional easement area or land acquisition would be required.
- Neither option requires compensatory storage for regulatory purposes since they both provide a greater than or equal amount of flood storage as existing conditions allow. If more flood storage is desired by the City then the land at 24 Caller Street can potentially be regraded to provide additional flood storage space.

#### 6.1.2 Durability

- This alternative requires inspections to be performed after flood events and a minimum level of maintenance such as replacing any dislodged rocks after a flood event and managing vegetation to prevent overgrowth.
- With proper maintenance and routine inspection, a rip rap slope should provide a minimum life span of 50 years.

#### 6.1.3 Environmental Impact

- Requires excavation of contaminated soils to form the rip rap slope.
- Requires dredging of the streambed to construct the toe of the rip rap slope.
- Stones in the existing channel wall can be incorporated into the riprap slope.

#### 6.1.4 Constructability & Construction Schedule

- This alternative is easy to construct and does not require any special equipment or methods.
- Water control will be necessary to construct the rip rap slope.
- Requires excavation of abandoned rail road east of Strongwater Brook.
- Requires demolition of the abandoned building foundation east of Strongwater Brook.
- Estimated construction duration is 5 months.

#### 6.1.5 Right-of-Way

- This alternative will require a maximum permanent easement that is approximately 25 feet wide from the face of the existing wall.
- A 15-foot-wide temporary easement for construction will be required as well.

### 6.2 Alternative B – Vegetative Berm Above Rip Rap Slope

Alternative B is similar to Alternative A except the rip rap slope for this alternative will stop at



approximately 3.5-feet above the river bed with the vegetative berm extending to the top of the slope. The slope of the vegetative berm would be 1 vertical to 3 horizontal. This alternative requires the removal of the existing south wall along the entire length in consideration.

Alternative B, like Alternative A, has the same two options for the location of the bottom of slope.

#### 6.2.1 *Resilience*

- Option 1 would provide 20 cu. ft./ft. additional flood storage capacity; Option 2 would match current flood storage capacity.
- The surface roughness of the rip rap and vegetative slope would decrease flood flow speed.
- Allows flexibility to vary slope along river length to allow more flood storage at key locations.
- In the future, both options can accommodate the future flood elevations by constructing a berm on top of the would-be existing slope, however the north wall height will also need to be increased to not cause increased flooding on the north side. The Riverwalk pathway would need to be located away from the top of slope to allow room for this potential future berm to be constructed. Additional easement area or land acquisition would be required.
- Neither option requires compensatory storage for regulatory purposes since they both provide a greater than or equal amount of flood storage as existing conditions allow. If more flood storage is desired by City, then the land at 24 Caller Street can potentially be regraded to provide additional flood storage space.

#### 6.2.2 *Durability*

- This alternative requires inspections to be performed after flood events and a minimum level of maintenance such as replacing any dislodged rocks after a flood event and managing vegetation to prevent overgrowth.
- With proper maintenance and routine inspection, a rip rap and vegetative slope should provide a minimum life span of 50 years.

#### 6.2.3 *Environmental Impact*

- Requires excavation of contaminated soils to form the rip rap slope.
- Requires dredging of the streambed to construct the toe of the rip rap slope.
- Stones in the existing channel wall can be incorporated into the riprap slope.

#### 6.2.4 *Constructability & Construction Schedule*

- This alternative is easy to construct and does not require any special equipment or methods.
- Water control will be necessary to construct the rip rap and vegetative slope.
- Requires excavation of abandoned rail road east of Strongwater Brook.
- Requires demolition of the abandoned building foundation east of Strongwater Brook.
- Estimated construction duration is 5 months, which does not include growing season of the vegetation.

#### 6.2.5 *Right-of-Way*

- This alternative will require a maximum permanent easement that is approximately 28 feet wide from the face of the existing wall.
- A 15-foot-wide temporary easement for construction will be required as well.

### 6.3 Alternative C – Sheet Pile Wall

Alternative C Option 1 consists of a sheet pile wall installed behind the existing wall to an approximate depth of 20 feet below the top of slope. The existing wall structure would be removed after the sheet piles are installed, providing a small increase in flood storage. A concrete cap would be constructed along the top of the sheet pile wall for a more aesthetic look and to cover the jagged top of the sheet piling. An available option for this alternative is architectural cladding, such as a stone veneer matching the aesthetics of the existing wall.

Alternative C Option 2 consists of a sheet pile wall installed behind the existing wall. The sheet pile would extend 2-feet above the canal bed, and 13-feet below ground. A sloped bank, of either rip rap or vegetative berm, would then extend from the top of the sheet pile to the top of bank. A rip rap slope would require more excavation of soils than the vegetative berm option but would be more stable during flood events. The vegetative berm would require less excavation than a rip rap slope but would be less stable during and after flood events. Both the rip rap slope and vegetative berm options would provide additional flood storage.

#### 6.3.1 Resilience

- Option 1 would increase flood storage by adding approximately 8.5 cu.ft./ft. of additional flood storage due to the removal of the existing stone masonry wall which increases the cross section of the channel.
- Option 2 would provide an additional 20-25 cu.ft./ft. additional flood storage due to the rip rap slope or vegetative berm.
- Height of wall can be increased in the future; however, the north wall height will also need to be increased to not cause increased flooding on the north side. Requires design and special detailing of the wall to accommodate future height addition (cost included in engineer's cost estimate).
- This option does not require compensatory storage for regulatory purposes since it provides greater storage capacity than currently available. If more flood storage is desired by City, then the land at 24 Caller Street can potentially be regraded to provide additional flood storage space.

#### 6.3.2 Durability

- Steel sheet piling requires very minimal maintenance, such as monitoring for deviation from design alignment and corrosion. The concrete coping would need to be checked for minor cracks and spalls at multiple times during its design life.
- Steel sheet piling can provide a minimum design life of 75 years.
- Rip rap requires inspections to be performed after flood events and a minimum level of maintenance such as replacing any dislodged rocks after a flood event. The vegetative berm would be less stable than the rip rap during and after flood events. The vegetative berm would also require scheduled maintenance of vegetation to prevent overgrowth.
- With proper maintenance and routine inspection, a rip rap slope should provide a minimum life span of 50 years.

#### 6.3.3 Environmental Impact

- Sheet pile installation will create more noise than the other alternatives. This may be able to be mitigated based on the installation methods needed.
- Option 1 requires the least amount of contaminated soil removal of all Alternatives considered.
- Option 2 requires no dredging of the stream bed.

#### 6.3.4 Constructability & Construction Schedule

- This alternative will require specialized equipment for the installation of the sheet piling.
- Water control will be necessary for the removal of the existing stone masonry wall.
- Requires excavation of abandoned rail road east of Strongwater Brook.
- Minimizes the demolition of the abandoned building foundation east of Strongwater Brook for Option 1.
- Estimated construction duration is 4-5 months

#### 6.3.5 Right-of-Way

- This alternative will require permanent easement that is approximately 15 feet wide from the face of the existing wall for Option 1 and up to 30 feet wide for Option 2.
- A 15-foot-wide temporary easement for construction will be required as well.

### 6.4 Alternative D – Cantilever Concrete Retaining Wall

Alternative D consists of removing the existing stone masonry wall and constructing a concrete cantilever retaining wall in the same location. The concrete retaining wall will have a footing constructed approximately 4 feet below the stream bed. The stem of the concrete wall will be approximately 14 inches wide at the top and about 30 inches wide at the base. A concrete form liner may be used to provide texture or the look of a stone veneer if desired.

#### 6.4.1 Resilience

- This alternative would not provide any increase in flood storage.
- Height of wall can be increased in the future; however, the north wall height will also need to be increased to not cause increased flooding on the north side. Requires design and special detailing of the wall to accommodate future height addition (cost included in engineer's cost estimate).
- This option does not require compensatory storage for regulatory purposes since it provides equal storage capacity as currently available. If more flood storage is desired by City, then the land at 24 Caller Street can potentially be regraded to provide additional flood storage space.

#### 6.4.2 Durability

- Requires minimal maintenance including minor spall or crack repairs; repairs will need to be completed multiple times during its design life.
- A concrete retaining wall, with proper maintenance, can provide a minimum design life of 75 years.

#### 6.4.3 Environmental Impact

- Requires excavation of contaminated soils.
- Requires dredging of the streambed to construct the footing.
- Requires over-excavation of organic soils to prevent settlement.

#### 6.4.4 Constructability & Construction Schedule

- This alternative does not require any specialized equipment or methods.
- Water control will be necessary for the removal of the existing stone masonry wall and construction of the new wall.
- Sheet piling should be permanently installed at the toe of the footing in areas of deep organic soils, such as at 24 Caller St and 166R Main St.



- Requires excavation of abandoned rail road east of Strongwater Brook.
- Requires demolition of the abandoned building foundation east of Strongwater Brook.
- Estimated construction duration is 6-8 months.

#### 6.4.5 *Right-of-Way*

- This alternative will require permanent easement that is approximately 15 feet wide from the face of the existing wall.
- A 15-foot-wide temporary easement for construction will be required as well.

### 6.5 **Alternative E – Stone Masonry Wall**

Alternative E consists of removing the existing stone masonry wall and constructing a new stone masonry wall on a concrete footing in the same location. The stem of the wall will be approximately 20 inches wide at the top and 4 feet at the base. The concrete footing would be constructed approximately 4 feet below the stream bed. This alternative would provide no additional flood storage space.

#### 6.5.1 *Resilience*

- This alternative would not provide any increase in flood storage.
- Height of wall can be increased in the future; however, the north wall height will also need to be increased to not cause increased flooding on the north side. Requires design and special detailing of the wall to accommodate future height addition (cost included in engineer's cost estimate).
- This option does not require compensatory storage for regulatory purposes since it provides greater storage capacity than currently available. If more flood storage is desired by the City then the land at 24 Caller Street can potentially be regraded to provide additional flood storage space.

#### 6.5.2 *Durability*

- The stone masonry retaining wall requires a moderate amount of maintenance such as repointing of masonry. The majority of maintenance will be required above the waterline; however, some areas may require maintenance and repair below the water level. Maintenance done below water level will require sandbags to divert water away from location of repairs.
- A stone masonry retaining wall, with proper maintenance, can provide a minimum design life of 50 years.

#### 6.5.3 *Environmental Impact*

- Requires excavation of contaminated soils.
- Requires dredging of the streambed to construct the footing.
- Requires over-excavation of organic soils to prevent settlement.

#### 6.5.4 *Constructability & Construction Schedule*

- This alternative does not require any specialized equipment or methods.
- Water control will be necessary for the removal of the existing stone masonry wall and construction of the new wall.
- Sheet piling should be permanently installed at the toe of the footing in areas of deep organic soils, such as at 24 Caller St and 166R Main St.
- Requires excavation of abandoned rail road east of Strongwater Brook.
- Requires demolition of the abandoned building foundation east of Strongwater Brook.
- Estimated construction duration is 7-9 months.

#### 6.5.5 *Right-of-Way*

- This alternative will require permanent easement that is approximately 15 feet wide from the face of the existing wall.
- A 15-foot-wide temporary easement for construction will be required as well.

## 7.0 REFERENCES INCREMENTAL APPROACH

Climate change projections indicate that, by 2100, mean sea level rise in Boston Harbor since 2000 is unlikely to exceed (83% probability) 4.0 feet although it could be as high as 10.2 feet (NECSC). Boston Harbor has seen a sea level rise of more than 11 inches between 1921 and 2018. Since the North River Canal is tidally influenced closer to Salem, it is possible the canal will experience an even higher likelihood of extreme flooding as the canal shoulder of the North River will likely become tidal. Since work is only being done to the south wall, a significant decrease in current riverine flooding is difficult without also working on the north wall. There are options and steps that can be taken to assure that the south wall of the North River Canal can be altered to accommodate larger flood events or to match future work done of the north wall.

Not all alternative options will be able to accommodate an added wall height in the future. The rip rap slope, vegetative berm and sheet pile walls could be altered to accommodate an increase wall height but may require additional land usage to do so. The stone masonry wall and concrete cantilever wall could be designed to accommodate future wall height increase. For it to be possible to increase the wall height in the future, the walls will need to be designed to have additional capacity than current conditions require.

Raising the South wall height in the future would only provide additional flood storage if the North wall height were also increased. If the South wall were to be raised in the future without raising the North wall as well, it would only increase flooding on the North side of the canal.

Additional investigations would still be required in the future to ensure the wall has available capacity and no deterioration or damage has occurred that would reduce the capacity of the walls.

.....



## 8.0 PERMITTING STRATEGY

### 8.1 Introduction

Weston & Sampson has developed five (5) design repair / replacement alternatives, Alternative A through Alternative E. Alternatives A, B, and C each included two separate options (options 1 & 2) for the south canal wall in order to support the construction of a Riverwalk and improve the flood resilience along the North River Canal. Wall alternatives include options for repairing the wall in place to protect against future flooding as well as other options that provide additional flood storage. Weston & Sampson then conducted a preliminary analysis and evaluated the permitting strategy for each of the proposed five (5) wall alternatives.

The permitting evaluation which follows in this chapter, first reviews each alternative for the amount of impact to resource areas, the required environmental permits associated with those impacts, permitting timelines, and finally permitting costs. In addition, an evaluation of the different wall options and associated permitting was also conducted based on the anticipated ease or feasibility of implementation with regulatory agencies, and other additional studies or requirements, and their associated costs, that may be required as part of for each wall alternative.

The five (5) wall alternatives that are being considered for the repair of the south wall of the North River Canal are:

- Alternative A – Rip Rap Slope
  - Option 1, build out from Toe of existing wall
  - Option 2, build out from inside of existing wall
- Alternative B – Vegetative Berm Over Rip Rap Slope
  - Option 1, build out from Toe of existing wall
  - Option 2, build out from inside of existing wall
- Alternative C – Sheet Pile Wall
  - Option 1, Sheet Pile with Concrete Cap
  - Option 2, Sheet Pile with Sloped Bank (rip-rap or vegetated berm)
- Alternative D – Cantilever Concrete Retaining Wall
- Alternative E – Stone Masonry Wall

Currently, it is infeasible to modify the north wall of the river, so these alternatives are only relative to the south wall. Furthermore, since the north wall is at a lower elevation than the current south wall for about half of the river length, there would be no point to raise the wall height to accommodate future flood levels, as it would just force the flood water to the north. In order to obtain additional flood storage from these repairs the river would need to be widened.

There is known or suspected soil contamination along the proposed Riverwalk area that will also need to be addressed, as each alternative will require the handling of soils to some extent. The permitting strategy detailed in this chapter report does not include any MCP permitting associated with the contamination found. Easements or property acquisition will be required for each alternative to accommodate the Riverwalk, with some alternatives requiring more property than others.

A description of the typical permits and requirements that might be required for each alternative can be seen in **Appendix K**. **Appendix L** provides a summary table of estimated regulatory impacts and likely permits required for each of the five options, while **Appendix M** provides a permit approval schedule for

each alternative.

Information presented in the permitting matrix in Section 8.3 - Permitting Summary and Recommendations, is described in greater detail, below.

## 8.2 Environmental Permitting Strategy

### 8.2.1 *Alternative A – Rip Rap Slope*

A rip rap slope would require the removal of the existing south wall along the entire length in consideration. The rip rap would be placed with a slope of 1 vertical to 1.5 horizontal; the stone can be locally sourced or reused from the current south wall. The rip rap will extend 5-feet into the river bed and 3.5-feet below the river bed to maintain continuity with the slope. Two options are presented for the location of the slope.

- Option 1 will begin the 1:1.5 slope where the current wall exists, providing additional flood storage along the slope.
- Option 2 will begin the 1:1.5 slope roughly 3.5-feet north of the south wall (in the river) providing no additional flood storage but maintaining the storage the current river width provides.

#### 8.2.1.1 *Regulatory Impacts*

Environmental resources that will be impacted with both Rip Rap Slope options include the following (all calculations are estimates based on current conceptual designs):

- Bank of perennial stream
  - For both rip rap options, an estimated 1,335 linear feet (lf) will be impacted due to the removal of the existing wall.
- Land under water associated with a perennial stream
  - Option 1 will result in Land Under Water (LUW) impacts of 6,700 sf and dredging of 24,800 cubic feet (cf) of material.
  - Option 2 will result in LUW impacts of 12,300 sf, 43,500 cf of dredge, and unknown amount of fill.
- 100-year flood zone
  - Option 1 would increase flood storage by adding approximately 24,000 CF of additional flood storage due to the removal of the existing stone masonry wall Option 2 will match existing storage volume
- Riverfront area
  - Option 1 will impact 26,000 sf
  - Option 2 will impact 21,000 sf

#### 8.2.1.2 *Potential Permits*

Potential permits required for both the rip rap slope alternatives include the following:

- MA Wetlands Protection Act Notice of Intent
- MassDEP 401 Water Quality Certification
- MassDEP Chapter 91 submission
- MEPA Environmental Notification Form
- US Army Corps of Engineers Individual Permit

A description of these permits and typical required documents has been included in *Appendix K*.

#### 8.2.1.3 Permit Costs

Permit costs can vary depending on resource area impacts, project complexity, and reviewer comments. The typical range of costs per likely required permit is provided below.

#### Permit Costs for Rip Rap Slope Options 1 or 2

Permit	Minimum Cost	Maximum Cost
MassDEP Wetlands NOI	5,000	10,000
MassDEP 401 WQC	5,000	10,000
MassDEP Ch 91	5,000	10,000
MEPA ENF	5,000	10,000
ACOE IP	5,000	10,000
<b>TOTAL</b>	<b>25,000</b>	<b>50,000</b>

Option 2 would most likely incur an additional \$10,000 -15,000 for additional studies related to mitigation/compensation design.

#### 8.2.1.4 Permit Approval Schedule

To efficiently gain permit approvals, it is recommended that the ENF be submitted first. The ENF is forwarded to those reviewers who would have jurisdiction or an interest in the project. Comments from these reviewers are forwarded to the MEPA reviewer, who compiles the comments and forwards them on to the project proponent.

It is helpful to get these comments first and incorporate these comments into the remaining permit submissions to minimize the amount of back and forth with reviewers. Once submitted, the review time for the ENF is approximately 60 days. After incorporating the ENF comments into the remaining permits, all remaining permits can be submitted simultaneously. The ACOE IP can take up to 135 days before gaining approval. The joint 401 WQC / Chapter 91 submission can take from approximately 150 – 400 days for review, depending on if MassDEP determines there are administrative or technical deficiencies with the submission and requests additional information. Finally, assuming the NOI review requires two (2) public meetings, the review process can take approximately 45 days.

In all, the environmental permit review process could take between **seven (7) and fifteen (15) months**.

#### 8.2.1.5 Alternative Favorability

When evaluating both options from a favorability standpoint, Option 1 presents a much more favorable approach from a wetland's perspective. Not only does it increase flood storage volume in the region, but it also requires no filling to LUW. Any fill within the river will be hard to permit through the various agencies, including DEP and ACOE. It will also require mitigation to replace lost wetland resource areas.

#### 8.2.2 Alternative B – Vegetative Berm Over Rip Rap Slope

The vegetative berm option would be a combination of rip rap slope and vegetative berm. The rip rap would have the same stone size and slope as Alternative A but would stop approximately 3.5-feet above



the river bed with the vegetative berm extending to the top of the slope. The slope of the vegetative berm would be 1 vertical to 3 horizontal. As with the rip rap slope, two options are presented for the location of the slope.

- Option 1 is to begin the rip rap slope where the existing wall is located and provide additional flood storage in the sloped area.
- Option 2 is to begin the rip rap slope roughly 3.75-feet north of the south wall (in the river) which would provide no additional flood storage but would maintain the currently available flood storage.

#### 8.2.2.1 *Regulatory Impacts*

Environmental resources that will be impacted with both vegetative berm options include the following (all calculations are estimates based on current conceptual designs):

- Bank of perennial stream
  - For both options, an estimated 1,335 linear feet (lf) of bank will be impacted
- Land under water
  - Option 1 will result in LUW impacts of 6,000 sf and dredging of 21,400 cubic feet (cf)
  - Option 2 will result in LUW impacts of 10,600 sf, 41,400 cf of dredge, and unknown amount of fill
- 100-year flood zone
  - Option 1 would increase flood storage by adding approximately 26,000 CF of additional flood storage due to the removal of the existing stone masonry wall
  - Option 2 will have negligible impact to the flood zone
- Riverfront area
  - Option 1 will impact 28,500 sf
  - Option 2 will impact 21,800 sf

#### 8.2.2.2 *Potential Permits*

Potential permits required for both vegetative berm alternatives include the following:

- MA Wetlands Protection Act Notice of Intent
- MassDEP 401 Water Quality Certification
- MassDEP Chapter 91 submission
- MEPA Environmental Notification Form
- US Army Corps of Engineers Individual Permit

A description of these permits and typical required documents has been included in Appendix J.

#### 8.2.2.3 *Permit Costs*

Permit costs can vary depending on resource area impacts, project complexity, and reviewer comments. The typical range of costs per likely required permit is provided on the following page.

## Permit Costs for Vegetative Berm Option

Permit	Minimum Cost	Maximum Cost
MassDEP Wetlands NOI	5,000	10,000
MassDEP 401 WQC	5,000	10,000
MassDEP Ch 91	5,000	10,000
MEPA ENF	5,000	10,000
ACOE IP	5,000	10,000
<b>TOTAL</b>	<b>25,000</b>	<b>50,000</b>

Option 2 would most likely incur an additional \$10,000 -15,000 for additional studies related to mitigation/compensation design.

8.2.2.4 *Permit Approval Schedule*

Much like Alternative A the approach of Alternative B would be similar with a review through the MEPA ENF process followed by a simultaneous review by the other agencies. In all, the environmental permit review process could take between **seven (7) and fifteen (15) months**.

8.2.2.5 *Alternative Favorability*

Similar to Alternative A, Alternative B, Option 1 presents a much more favorable approach from a wetland's perspective. Not only does it increase flood storage volume in the region, but it also requires no filling to LUW. Any fill within the river will be hard to permit through the various agencies, including DEP and ACOE. It will also require mitigation to replace lost wetland resource areas.

The vegetative berm approach also has the added benefit of providing habitat to the stream. In many agencies minds this presents a greener solution than the rip rap slope does and could potentially be seen as the desired and preferred alternative from a regulatory perspective.

8.2.3 *Alternative C – Sheet Pile Wall*

A sheet pile wall would require the removal of the existing wall structure. The existing wall structure would be removed after the sheet piles were installed just behind the existing wall. The height of the sheet pile walls can vary along the length of the canal or maintain a constant height. By removing the existing wall after installation of the sheet piles, a small increase in the canal flood storage will be achieved.

- Option 1 consists of a sheet pile wall installed behind the existing wall to an approximate depth of 20 feet below the top of slope. The existing wall structure would be removed after the sheet piles are installed, providing a small increase in flood storage. A concrete cap would be constructed along the top of the sheet pile wall for a more aesthetic look and to cover the jagged top of the sheet piling. An available option for this alternative is architectural cladding, such as a stone veneer matching the aesthetics of the existing wall.
- Option 2 consists of a sheet pile wall installed behind the existing wall. The sheet pile would extend 2-feet above the canal bed, and 13-feet below ground. A rip rap or vegetative slope, much like Alternatives A and B, would then extend from the top of the sheet pile to the top of bank.

### 8.2.3.1 Regulatory Impacts

Environmental resources that will be impacted with this option include the following (all calculations are estimates based on current conceptual designs):

- Bank of perennial stream
  - An estimated 1,335 linear feet (lf) of bank will be impacted
- Land under water
  - Temporary LUW impacts associated with demolition of south wall
- 100-year flood zone
  - Option 1 would increase flood storage by adding approximately 10,700 CF of additional flood storage due to the removal of the existing stone masonry wall
  - Option 2 would provide approximately 37,000 CF of flood storage due to the removal of wall and addition of a rip rap slope. If the slope were constructed as a vegetative berm, the additional flood storage would be increased to 44,000 CF.
- Riverfront area
  - Option 1 will impact 17,200 sf
  - Option 2 will impact 20,000 sf

### 8.2.3.2 Potential Permits

Potential permits required for the sheet pile wall alternative include the following:

- MA Wetlands Protection Act Notice of Intent
- MEPA Environmental Notification Form
- US Army Corps of Engineers Individual Permit
- MassDEP 401 Water Quality Certification

A description of these permits and typical required documents has been included in Appendix K.

### 8.2.3.3 Permit Costs

Permit costs can vary depending on resource area impacts, project complexity, and reviewer comments. The typical range of costs per likely required permit is provided, below.

#### Permit Costs for Sheet Pile Option

Permit	Minimum Cost	Maximum Cost
MassDEP Wetlands NOI	5,000	10,000
MEPA ENF	5,000	10,000
ACOE IP	5,000	10,000
401 WQC	5,000	10,000
Add'l Cost Analysis	5,000	10,000
<b>TOTAL</b>	<b>25,000</b>	<b>50,000</b>

An additional cost analysis may be needed to prove this Alternative is the preferred Alternative. We estimate that additional cost to be \$5,000 -10,000 as explained in Section 8.3.



#### 8.2.3.4 Permit Approval Schedule

Much like Alternative A and B, the approach of Alternative C would be similar with a review through the MEPA ENF process followed by a simultaneous review by the other agencies. The only permit that most likely will not be necessary is the Chapter 91 permit, as there will be no jurisdictional work within the waterway. Although this is only 1 permit fewer than the first alternatives, the CH91 permit has a lengthy review timeframe and by avoiding it, the project could cut the permitting approval process in half. In all, the environmental permit review process could take **up to seven (7) months**.

#### 8.2.3.5 Alternative Favorability

Although this Alternative C - Option 1 is a suitable alternative for repair of the existing south wall, it provides no extra environmental benefit from a regulatory standpoint, with the exception of a marginal flood storage benefit.

Because the current wall is a vertical wall, it would be permissible as a replacement of the existing conditions. However, with other more favorable alternatives present, the City would have to show how other options would be less practicable based on at least the following considerations:

- Costs and whether such costs are reasonable or prohibitive to the owner;
- Existing technology; and
- Logistics considering the overall project purposes

Alternative C- Option 2 presents a more favorable approach than Alternative C - Option 1 from a regulatory perspective as it provides additional flood storage. If combined with the greener solution of a vegetated berm, then it could even provide some habitat benefit, as well.

#### 8.2.4 Alternative D – Cantilever Concrete Retaining Wall

A cantilever concrete retaining wall would replace the existing south wall. Excavation would be required for the placement of the footing. The stem of the concrete wall will be approximately 14 inches wide at the top and about 30 inches wide at the base. A concrete form liner may be used to provide texture or the look of a stone veneer if desired.

##### 8.2.4.1 Regulatory Impacts

Environmental resources that will be impacted with this option include the following (all calculations are estimates based on current conceptual designs):

- Bank of perennial stream
  - An estimated 1,335 linear feet (lf) of bank will be impacted
- Land under water
  - Temporary LUW impacts associated with demolition of south wall
- 100-year flood zone
  - Marginal increase in flood storage from removal of wall
- Riverfront area
  - Will impact 14,800 sf

##### 8.2.4.2 Potential Permits

Potential permits required for the cantilever retaining wall alternative include the following:

- MA Wetlands Protection Act Notice of Intent

- MEPA Environmental Notification Form
- US Army Corps of Engineers Individual Permit
- 401 Water Quality Certification

A description of these permits and typical required documents has been included in Appendix J.

#### 8.2.4.3 Permit Costs

Permit costs can vary depending on resource area impacts, project complexity, and reviewer comments. The typical range of costs per likely required permit is provided on the following page.

#### Permit Costs for Cantilever Retaining Wall Option

Permit	Minimum Cost	Maximum Cost
MassDEP Wetlands NOI	5,000	10,000
MEPA ENF	5,000	10,000
ACOE IP	5,000	10,000
401 WQC	5,000	10,000
Add'l Cost Analysis	5,000	10,000
<b>TOTAL</b>	<b>25,000</b>	<b>50,000</b>

An additional cost analysis may be needed to prove this Alternative is the preferred Alternative. We estimate that additional cost to be \$5,000 -10,000 as explained in Section 8.3.

#### 8.2.4.4 Permit Approval Schedule

Alternative D would replicate the schedule of Alternative C, with a review through the MEPA ENF process followed by a simultaneous review by the other agencies. Again, no CH 91 permit review would be necessary and therefore permitting review timelines would be reduced.

In all, the environmental permit review process could take **up to seven (7) months**.

#### 8.2.4.5 Alternative Favorability

Similar to Alternative C, this alternative is a suitable alternative for repair of the existing south wall, however it provides no extra environmental benefit from a regulatory standpoint. It only provides a marginal flood storage benefit and no habitat benefit to the resource area.

Because the current wall is a vertical wall, it would be permissible as a replacement of the existing conditions. However, with other more favorable alternatives present, the City would have to show how other options would be less practicable based on at least the following considerations:

- Costs and whether such costs are reasonable or prohibitive to the owner;
- Existing technology; and
- Logistics considering the overall project purposes

To make this alternative more favorable the wall could be pushed back farther south, and the river widened to allow for increased flood storage.

### 8.2.5 *Alternative E – Stone Masonry Wall*

The stone masonry wall would replace the existing stone masonry wall with a new concrete footing in the same location. The stem of the wall will be approximately 20 inches wide at the top and 4 feet at the base. The concrete footing would be constructed approximately 4 feet below the stream bed. This alternative would provide no additional flood storage space.

#### 8.2.5.1 *Regulatory Impacts*

Environmental resources that will be impacted with this option include the following (all calculations are estimates based on current conceptual designs):

- Bank of perennial stream
  - An estimated 1,335 linear feet (lf) of bank will be impacted
- Land under water
  - Temporary LUW impacts associated with demolition of south wall
- 100-year flood zone
  - Marginal increase in flood storage from removal of wall
- Riverfront area
  - Will impact 15,900 sf

#### 8.2.5.2 *Potential Permits*

Potential permits required for the stone masonry wall alternative include the following:

- MA Wetlands Protection Act Notice of Intent
- MEPA Environmental Notification Form
- US Army Corps of Engineers Individual Permit
- 401 Water Quality Certification

A description of these permits and typical required documents has been included in Appendix K.

#### 8.2.5.3 *Permit Costs*

Permit costs can vary depending on resource area impacts, project complexity, and reviewer comments. The typical range of costs per likely required permit is provided below

#### Permit Costs for Stone Masonry Wall Option

Permit	Minimum Cost	Maximum Cost
MassDEP Wetlands NOI	5,000	10,000
MEPA ENF	5,000	10,000
ACOE IP	5,000	10,000
401 WQC	5,000	10,000
Add'l Cost Analysis	5,000	10,000
<b>TOTAL</b>	<b>25,000</b>	<b>50,000</b>

An additional cost analysis may be needed to prove this Alternative is the preferred Alternative. We estimate that additional cost to be \$5,000 -10,000 as explained in Section 8.3.



#### 8.2.5.4 Permit Approval Schedule

Alternative E would replicate the schedule of Alternative C and D, with a review through the MEPA ENF process followed by a simultaneous review by the other agencies. Again, no CH 91 permit review would be necessary and therefore permitting review timelines would be reduced.

In all, the environmental permit review process could take **up to seven (7) months**

#### 8.2.5.5 Alternative Favorability

Similar to both Alternatives C and D, this alternative is a suitable alternative for repair of the existing south wall, however it provides no extra environmental benefit from a regulatory standpoint. It only provides a marginal flood storage benefit and no habitat benefit to the resource area.

Because the current wall is a vertical wall, it would be permissible as a replacement of the existing conditions. However, with other more favorable alternatives present, the City would have to show how other options would be less practicable based on at least the following considerations:

- Costs and whether such costs are reasonable or prohibitive to the owner;
- Existing technology; and
- Logistics considering the overall project purposes

To make this alternative more favorable the wall could be pushed back farther south, and the river widened to allow for increased flood storage.

### 8.3 Permitting Summary and Recommendations

Weston & Sampson has produced five (5) design alternatives (three with sub options for a total of eight total alternatives) for repair / replacement options for the south wall along the North River Canal in order to support the proposed construction of a Riverwalk and to improve the flood resilience along the North River Canal. Each of these designs has been evaluated for five (5) different variables, including impacts to protected environmental resources, required permits, permit costs, permit approval schedule and regulatory favorability. For each alternative, each variable was given a value, with lower values indicating lesser preferred alternative results. A summary table showing each alternative with five different variable results are provided in *Appendix K*.

In general, the more complicated the wall repair, the greater the number of environmental resources and impact areas, which results in a greater number of environmental permits being required along with increased costs and schedule duration. As a result of this analysis, it should be noted that the alternatives fall into one of two groups, those that require permanent work within land under water (Alternative A and B), and those that do not require permanent work within land under water (Alternative C, D and E). For those alternatives that impact land under water, an additional permit (MassDEP Chapter 91) will be required and result in additional project costs and permitting approval duration.

In general, the only difference between these two groups of alternatives from a permit cost and schedule context is approximately \$5k-\$10k in costs and 7-8 months in review. However, when providing additional overall project cost analysis study, the cost of C, D and E are comparable to Option 1 in both Alternatives A and B. Furthermore Option 2 in Alternatives A and B add even more costs associated with further design required for mitigation of lost resource areas. Therefore, Option 1 in Alternative A and B, Alternative C, Alternative D, and Alternated E all have roughly the same costs when factoring in the Permit costs and Additional Overall Cost Analysis. The additional studies required as part of Option

2 for Alternative A and B would make those choices more expensive. See table below:

### Potential Permitting Costs

	Alt A, Opt. 1	Alt A, Opt. 2	Alt. B, Opt. 1	Alt. B, Opt. 2	Alt. C, Opt. 1	Alt. C, Opt. 2	Alt. D	Alt. E
<b>Costs (\$)</b>	\$25,000 - \$50,000	\$35,000 - \$65,000	\$25,000 - \$50,000	\$35,000 - \$65,000	\$25,000 - \$50,000	\$25,000 - \$50,000	\$25,000 - \$50,000	\$25,000 - \$50,000

Given the relatively small difference in cost and timing of the permits required for each alternative, Weston & Sampson evaluated the anticipated favorability of each alternative from a regulatory perspective. Each permitting agency will be evaluating the potential impacts of resource areas that will be impacted by the proposed alternative; most notably bank and land under water. Although any repair alternative work will be performed within the flood plain, the intent of the overall project will be to increase flood storage and not fill the flood plain, which will also be looked at favorably by the regulatory agencies. Additionally, work will also be completed in the riverfront area, however the portion of the riverfront area that will be impacted is previously developed and any project of this magnitude that has a goal of cleaning up the riverfront is anticipated to be looked at favorably by the permitting agency reviewer.

The following is an excerpt of the performance standards for bank and land under water in the wetland's protection act:

*"General Performance Standards (Land Under Water).*

(a) Where the presumption set forth in 310 CMR 10.56(3) is not overcome, any proposed work within Land under Water Bodies and Waterways shall not impair the following:

1. The water carrying capacity within the defined channel, which is provided by said land in conjunction with the banks;
2. Ground and surface water quality;
3. The capacity of said land to provide breeding habitat, escape cover and food for fisheries; and
4. The capacity of said land to provide important wildlife habitat functions. A project or projects on a single lot, for which Notice(s) of intent is filed on or after November 1, 1987, that (cumulatively) alter(s) up to 10% or 5,000 square feet (whichever is less) of land in this resource area found to be significant to the protection of wildlife habitat, shall not be deemed to impair its capacity to provide important wildlife habitat functions. Additional alterations beyond the above threshold may be permitted if they will have no adverse effects on wildlife habitat, as determined by procedures established under 310 CMR 10.60."

*"General Performance Standard (BANK).*

(a) Where the presumption set forth in 310 CMR 10.54(3) is not overcome, any proposed work on a Bank shall not impair the following:

1. the physical stability of the Bank;
2. the water carrying capacity of the existing channel within the Bank;
3. groundwater and surface water quality;
4. the capacity of the Bank to provide breeding habitat, escape cover and food for fisheries;
5. the capacity of the Bank to provide important wildlife habitat functions. A project or projects on a single lot, for which Notice(s) of Intent is filed on or after November 1, 1987, that (cumulatively) alter(s) up to 10% or 50 feet (whichever is less) of the length of the bank found to be significant to the protection of wildlife habitat, shall not be deemed to impair its capacity to provide important wildlife habitat functions. Additional alterations beyond the above threshold may be permitted if they will have no adverse effects on wildlife habitat, as determined by procedures contained in 310 CMR 10.60."

Although they are listed as two (2) different resource areas, the performance standards for both are very similar. Essentially LUW and Bank need to provide the following:

- Stability,
- Water carrying capacity,
- Ground water and surface water quality,
- Habitat for fisheries, and
- Capacity of land to provide other wildlife habitat functions

Although these are just performance standards under the Massachusetts Wetlands Protection Act, and both resource areas are also protected under the Army Corp Section 404 and Mass DEP Section 401 of the Clean Water Act, as well as Mass DEP Chapter 91 regulations, the intent of the protection remains the same throughout.

So, when evaluating each alternative, we must review them to these standards to see if they Meet (M), Improve (I) or Diminish (D) each standard.

#### Alternative Evaluation against Performance Standards

	Stability	Water Carrying	Water Quality	Habitat for Fisheries	Wildlife Habitat	Total
Alternative A Option 1	Improve	Improve	Improve	Improve	Meet	4 I, 1 M
Alternative A Option 2	Improve	Diminish	Diminish	Diminish	Meet	1 I, 1 M, 3 D
Alternative B Option 1	Improve	Improve	Improve	Improve	Improve	5 I
Alternative B Option 2	Improve	Diminish	Diminish	Diminish	Improve	2 I, 3 D
Alternative C Option 1	Improve	Improve	Meet	Meet	Meet	2 I, 3 M
Alternative C Option 2	Improve	Improve	Meet	Meet	Improve (if veg berm)	3 I, 2 M
Alternative D	Improve	Meet	Meet	Meet	Meet	1 I, 4 M
Alternative E	Improve	Meet	Meet	Meet	Meet	1 I, 4 M

As can be seen above, Option 2 for both Alternative A and B would diminish the quality of the resource areas impacted by the project. Based on the location of the wall in both scenarios, fill would need to be placed within the existing land under water. This would diminish the river's existing ability to carry water, treat the water and provide fish habitat. Because these alternatives would result in a diminished resource area, the agencies would more than likely require some type of mitigation to replicate the lost function of the resource area lost. This would require additional studies (hydraulic, water quality, habitat evaluations, etc.) and design of replication/restoration areas in order to determine exactly what functions were being lost and how to best replicate them on the same stretch of river.

Alternatives D, and E would meet the standards, but would provide no benefit or improvement, except for stabilizing the wall. Alternatives C - Option 1 rates slightly higher as it would improve on 1 standard by increasing water carrying capacity. Because the river is currently confined between two vertical walls



throughout this stretch, an argument could be made that all three alternatives should be allowable, as the work will not diminish what currently exists. Agencies would most likely require additional information to determine why these three alternatives were preferred over others that may provide more benefit to the site. Additional information could include an overall project cost analysis of each alternative and additional information on property rights along the river. For instance, acquisition of private land in order to complete Alternative B may be cost prohibitive and not preferred over another alternative that had a smaller footprint and required less acquisition of land. The proponent would be required to prove that the selected alternative, although possibly not the most environmentally preferred, was selected for other preferential reasons.

Alternative B - Option 1, Alternative A - Option 2, and Alternative C - Option 2 provide the most favorable alternatives when compared to the standards. Because these options include the expansion of the width of the river, the creation of Land Under Water and the gradual sloping of the bank, all three options would improve upon various criteria within the standards.

Although not called out specifically in the performance standards there are still other environmental considerations that will factor into overall favorability. Special consideration should also be given to alternatives that provide other benefits, such as the creation of flood storage volume. When rating each alternative based on their potential long-term impact to increasing storage along the river, Alternative B - Option 1, Alternative A - Option 1 and Alternative C - Option 2 rate out the most favorable, in that order.

In summary, the evaluated alternatives ranked accordingly highest to lowest based on regulatory favorability:

- Alternative B - Option 1 (provides 5 improvements and provides flood storage)
- Alternative A - Option 1 (provides 4 improvements and provides flood storage)
- Alternative C - Option 2 (provides 3 improvement and provides flood storage)
- Alternative C - Option 1 (provides 2 improvement and meets others)
- Alternative D (provides 1 improvement, additional study required to show why selected)
- Alternative E (provides 1 improvement, additional study required to show why selected)
- Alternative B - Option 2 (will diminish resource area, additional studies for impact and replication)
- Alternative A - Option 2 (will diminish resource area, additional studies for impact and replication)

Utilizing the five standards and flood plain considerations mentioned above, we have included a Permitting Strategy Matrix on the following page for the project. Although the matrix rates out four alternatives relatively close, careful consideration should be taken to which variables are more important to the client.

Given the relatively small difference in cost and timing of the permits (when compared to the general wall repair costs, etc.) these factors are less likely to impact the City's decisions as to which alternative to choose. More important factors, such as favorability or the likelihood and ease of which approvals can be obtained from the agencies might be the governing factor. This would be evident in the favorability ranking of each alternative. Please see the Permitting Strategy Matrix Summary provided on the following page:

.....

## Permitting Strategy Matrix Summary

	A.1 - Rip Rap Slope	A.2 - Rip Rap Slope	B.1 - Vegetative Berm	B.2 - Vegetative Berm	C.1 - Sheet Pile Wall	C.2- Sheet Pile Wall w/ Sloped Bank	D - Cantilever Concrete Retaining Wall	E - Stone Masonry Wall
Impacts (1-7)	3	1	4	2	5	5	7	6
Permits (1-7)	5	1	5	1	6	6	6	6
Costs (1-7)	3	1	3	1	3	3	3	3
Favorability (1-8)	7	1	8	2	3	6	3	3
Schedule (1-7)	3	1	3	1	4	4	4	4
<b>Total Average</b>	4.2	1.0	4.6	1.4	4.2	4.8	4.6	4.4

lower number = less preferred alternative

higher number = more preferred alternative

## 9.0 COMPREHENSIVE COMPARATIVE MATRIX

The following is a comprehensive comparative matrix to assist the City when comparing each of the repair design alternatives outlined in this report. Please note that this is not a final construction cost estimate. The preliminary cost estimates provided for each conceptual alternative only include major items associated with each wall design and are to be used for comparative purposes only. These preliminary cost estimates are not representative of the final construction costs as they do not include minor items that will be required for the implementation of each alternatives such as site preparation work, clearing and grubbing, erosion controls, etc.

Please refer to the assumptions presented in *Appendix I – Wall Alternative Cost Estimates*. Please note that the cost estimates assume that only impacted soils associated with wall repair activities are removed from the site and are transported and disposed of at a licensed, out-of-state non-hazardous disposal/recycling facility. This does not include any soils that may need to be removed from the site associated with the future construction of the proposed Riverwalk, etc., as the preliminary design of the Riverwalk has not been completed at this time.



ENGINEERING EVALUATION & DESIGN ALTERNATIVE  
ANALYSIS

	Resiliency & Flood Storage	Durability & Maintenance	Estimated Excavation	Construction & Easements	Permitting & Regulatory Favorability	Preliminary Cost Estimate *
<b>Alt A - Rip Rap Option 1</b>	<ul style="list-style-type: none"> <li>- Approx. 18 cu.ft./ft additional flood storage</li> <li>- Future height increase possible</li> <li>- Max. % of parcels protected ranges from 30%-55%</li> </ul>	<ul style="list-style-type: none"> <li>- Minimum design service life 50 years</li> <li>- Low maintenance (i.e. replace dislodged riprap after storm events)</li> </ul>	<ul style="list-style-type: none"> <li>- Requires excavating ~3000 CY of contaminated soils</li> </ul>	<ul style="list-style-type: none"> <li>- Requires 25-ft permanent easement from edge of river</li> <li>- Additional 15-ft temporary easement for construction</li> <li>- Approx. 5-month construction</li> </ul>	<ul style="list-style-type: none"> <li>- 4<sup>th</sup> in Total Permitting Favorability (tie)</li> <li>- 2<sup>nd</sup> in Regulatory Favorability</li> <li>- 4 Improved Resources</li> </ul>	\$2,607,000 – \$9,926,000
<b>Alt A - Rip Rap Option 2</b>	<ul style="list-style-type: none"> <li>- Approx. 1 cu. ft./ft. additional flood storage</li> <li>- Future height increase possible</li> <li>- Max. % of parcels protected ranges from 11%-17%</li> </ul>	<ul style="list-style-type: none"> <li>- Minimum design service life 50 years</li> <li>- Low maintenance (i.e. replace dislodged riprap after storm events)</li> </ul>	<ul style="list-style-type: none"> <li>- Requires excavating ~1500 CY of contaminated soils</li> </ul>	<ul style="list-style-type: none"> <li>- Requires 21-ft permanent easement from edge of river</li> <li>- Additional 15-ft temporary easement for construction</li> <li>- Approx. 5-month construction</li> </ul>	<ul style="list-style-type: none"> <li>- Lowest scoring (8<sup>th</sup>) alternative in Total Permitting Favorability</li> <li>- Lowest (8<sup>th</sup>) Regulatory Favorability</li> <li>-Diminishes Resources &amp; Need for additional studies</li> </ul>	\$2,615,000 - \$8,459,000
<b>Alt B - Vegetative Berm Option 1</b>	<ul style="list-style-type: none"> <li>- Approx. 20 cu.ft./ft. additional flood storage</li> <li>- Future height increase possible</li> <li>- Max. % of parcels protected ranges from 31%-60%</li> </ul>	<ul style="list-style-type: none"> <li>- Minimum design service life 50 years</li> <li>- Low to Moderate maintenance required (i.e. maintain vegetation, replace rip rap and/or soils, etc. after storm events)</li> </ul>	<ul style="list-style-type: none"> <li>- Requires excavating ~3000 CY of contaminated soils</li> </ul>	<ul style="list-style-type: none"> <li>- Requires 28-foot permanent easement from edge of river</li> <li>- Additional 15-foot temporary easement for construction</li> <li>- Approx. 5-9-month construction (depends on growing season)</li> </ul>	<ul style="list-style-type: none"> <li>- 2<sup>nd</sup> in Total Permitting Favorability (tie)</li> <li>- Highest (1<sup>st</sup>) Regulatory Favorability</li> <li>-5 Improved Resources</li> </ul>	\$2,479,000 - \$9,712,000

ENGINEERING EVALUATION & DESIGN ALTERNATIVE  
ANALYSIS

<b>Alt B - Vegetative Berm Option 2</b>	<ul style="list-style-type: none"> <li>- Approx. 1 cu.ft./ft. additional flood storage</li> <li>- Future height increase possible</li> <li>- Max. % of parcels protected ranges from 11%-17%</li> </ul>	<ul style="list-style-type: none"> <li>- Minimum design service life 50 years</li> <li>- Low to Moderate maintenance required (i.e. maintain vegetation, replace rip rap and/or soils, etc. after storm events)</li> </ul>	<ul style="list-style-type: none"> <li>- Requires excavating ~1400 CY of contaminated soils</li> </ul>	<ul style="list-style-type: none"> <li>- Requires 25-foot permanent easement from edge of river</li> <li>- Additional 15-foot temporary easement for construction</li> <li>- Approx. 5-9-month construction (depends on growing season)</li> </ul>	<ul style="list-style-type: none"> <li>- 5<sup>th</sup> in Total Permitting Favorability</li> <li>- 7<sup>th</sup> (second to last) in Regulatory Favorability</li> <li>- Diminishes Resources &amp; Need for additional studies</li> </ul>	<p>\$2,421,000 - \$8,103,000</p>
<b>Alt C – Sheet Pile Wall Option 1</b>	<ul style="list-style-type: none"> <li>- Approx. 8.5 cu.ft./ft. additional flood storage</li> <li>- Future height increase possible</li> <li>- Max. % of parcels protected ranges from 20%-45%</li> </ul>	<ul style="list-style-type: none"> <li>- Minimum design service life 75 years</li> <li>- Low maintenance required (i.e. monitor sheet piles for corrosion, crack and spall repairs of concrete cap)</li> </ul>	<ul style="list-style-type: none"> <li>- Requires excavating ~400 CY of contaminated soils</li> </ul>	<ul style="list-style-type: none"> <li>- Requires 13-foot permanent easement from edge of river</li> <li>- Additional 15-foot temporary easement for construction</li> <li>- Specialized construction methods</li> <li>- Approx. 4-5-month construction</li> </ul>	<ul style="list-style-type: none"> <li>- 4<sup>th</sup> in Total Permitting Favorability (tie)</li> <li>- 4<sup>th</sup> in Regulatory Favorability</li> <li>- Limited Improvements &amp; Need for additional studies</li> </ul>	<p>\$2,678,000 - \$3,422,000</p>
<b>Alt C – Sheet Pile Wall Option 2 w/ Sloped Bank</b>	<ul style="list-style-type: none"> <li>- Approx. 20-25 cu.ft./ft. additional flood storage</li> <li>- Future height increase possible</li> <li>- Max. % of parcels protected ranges from 31%-60%</li> </ul>	<ul style="list-style-type: none"> <li>- Minimum design service life 50 years</li> <li>- Low to Moderate maintenance required (i.e. monitor sheet piles for corrosion; replace dislodged rip rap after storm events; maintain vegetative berm which is less stable than rip rap during and after storm events and may require minor repair)</li> </ul>	<ul style="list-style-type: none"> <li>- Requires excavating:  ~2600 CY of contaminated soils for Rip Rap option  ~1500 CY of contaminated soils for Earthen Berm</li> </ul>	<ul style="list-style-type: none"> <li>- Requires 28-foot permanent easement from edge of river</li> <li>- Additional 15-foot temporary easement for construction</li> <li>- Approx. 5-month construction</li> </ul>	<ul style="list-style-type: none"> <li>- Highest (1<sup>st</sup>) in Total Permitting Favorability</li> <li>- 3<sup>rd</sup> in Regulatory Favorability</li> <li>- 3 Improved Resources but Meet all others</li> </ul>	<p>\$2,332,000 - \$5,060,000 (w/ Earthen Berm)  \$2,726,000 - \$7,214,000 (w/ Rip Rap)</p>

ENGINEERING EVALUATION & DESIGN ALTERNATIVE ANALYSIS

<p><b>Alt D - Concrete Cantilever Retaining Wall</b></p>	<ul style="list-style-type: none"> <li>- No increased river flood storage</li> <li>- Future height increase possible</li> <li>- No % of parcels protected</li> </ul>	<ul style="list-style-type: none"> <li>- Minimum design service life 75 years</li> <li>- Moderate maintenance required (i.e. crack and spall repairs)</li> </ul>	<ul style="list-style-type: none"> <li>- Requires excavating ~1900 CY of contaminated soils</li> </ul>	<ul style="list-style-type: none"> <li>- Requires 13-foot permanent easement from edge of river</li> <li>- Additional 15-foot temporary easement for construction</li> <li>- Requires removal of organic soils to prevent settlement</li> <li>- Approx. 6-8-month construction</li> </ul>	<ul style="list-style-type: none"> <li>- 2<sup>nd</sup> in Total Permitting Favorability (tie)</li> <li>- 5<sup>th</sup> in Regulatory Favorability</li> <li>- limited Improvement &amp; need for additional studies</li> </ul>	<p>\$4,832,000 - \$9,834,000</p>
<p><b>Alt E - Stone Masonry Wall</b></p>	<ul style="list-style-type: none"> <li>- No additional river flood storage</li> <li>- Future height increase possible</li> <li>- No % of parcels protected</li> </ul>	<ul style="list-style-type: none"> <li>- Minimum design service life 50 years</li> <li>- Moderate maintenance required (i.e. repointing of mortar, replace dislodged stones)</li> </ul>	<ul style="list-style-type: none"> <li>- Requires excavating ~2100 CY of contaminated soils</li> </ul>	<ul style="list-style-type: none"> <li>- Requires 13-foot permanent easement from edge of river</li> <li>- Additional 15-foot temporary easement for construction</li> <li>- Requires removal of organic soils to prevent settlement</li> <li>- Approx. 7-9-month construction</li> <li>- Requires removal of organic soils to prevent settlement</li> </ul>	<ul style="list-style-type: none"> <li>- 3<sup>rd</sup> in Total Permitting Favorability</li> <li>- 6<sup>th</sup> in Regulatory Favorability</li> <li>- limited Improvement &amp; need for additional studies</li> </ul>	<p>\$4,328,000 - \$9,702,000</p>

\* Upper cost range assumes all impacted soil/sediment subject to federal/EPA land ban disposal restrictions



## 10.0 CONCLUSIONS

The comparative matrix in the previous section was used to determine the highest-ranking wall alternative option for this project. Factors with the most importance during this decision were: cost, quantity of impacted soils requiring excavation and off-site disposal, volume of dredged material, favorability by regulatory agencies in obtaining permits, feasibility of providing additional flood storage, and the ease of adding a Riverwalk behind the wall.

In general, the least expensive alternatives were: 1) Alternatives C – Sheet Pile options; 2) Alternatives B – Vegetative Berm options; and Alternatives A- Rip Rap options. The alternatives which require the least estimated amount of material to be dredged from the canal are: 1) Alternatives C – Sheet Pile options; 2) Alternative D - Cantilever Wall; and 3) Alternative E - Stone Masonry wall. Adding a Riverwalk behind the sheet pile wall option 1, concrete cantilever wall or stone masonry wall may prove difficult at certain locations where a cantilever walkway would become necessary. At those difficult locations, the two rip rap options, the two vegetative berm options, and sheet pile option 2 would allow for the use of piers to avoid a cantilever walkway and thus likely reduce costs.

Therefore, Alternative C – Sheet Pile Wall Option 2 with Sloped Bank is the highest scoring alternative. However, Alternative C- Option 2 may not be feasible along the entire length due to existing structures and grade, such as the parking lot at 21 Caller Street, and may require a limited length of one of the other wall alternatives to be considered. As an example, the Sheet Pile Wall Option 1 could be used for a short distance along the bank until a larger portion of land is available behind the wall to return to the Sheet Pile Wall Option 2. The feasibility in areas such as 21 Caller Street will need to be further evaluated during the preliminary design and may depend on other factors such as property easements or acquisition potential.

Other well-scoring options during the comparison evaluation were: Alternative C - Sheet Pile Wall - Option 1; Alternative B - Vegetative Berm - Option 1; and Alternative A - Rip Rap - Option 1. The highest-ranking wall option, Alternative C - Sheet Pile Wall - Option 2 with Sloped Bank, combines all the favorable qualities of Alternatives A and B with the favorable qualities of Sheet Pile Option 1 and provides the highest percentage of potential parcel protection for all six flood-climate change projection scenarios.

While Alternative C - Sheet Pile Wall options generally cost about the same as Alternative B - Vegetative Berm Option 1, the sheet pile walls' low maintenance, ease of construction and long lifespan make it a good option and this alternative also does not require any material to be dredged from the canal. Alternative A - Rip Rap Option 1 was ranked closely behind Alternative B because of its similar characteristics to the Vegetative Berm Option 1 but ranked slightly lower due to its greater construction costs and lower total permitting favorability. The estimated cost of Alternative C – Sheet Pile Wall – Option 2 is slightly lower than these other well-scoring options due to the limited excavation and channel dredging required. Alternatives A – Option 1, B – Option 1 and C – Option 2 require roughly the same easement widths.

## 11.0 REFERENCES

This report has prepared the report for the use by the City of Peabody and the Massachusetts Executive Office of Energy & Environmental Affairs (MassEEA), and the design and construction teams for this project and this site only. The information herein could be used for bidding or estimating purposes but should not be construed as a warranty of subsurface conditions. We have made observations only at the aforementioned locations and only to the stated depths. These observations do not reflect soil types, strata thicknesses, or water levels that may exist between observations. Weston & Sampson should be retained during final design to complete additional geotechnical analyses as necessary and review final design and specifications to ensure that our recommendations are suitably followed.

The findings provided by Weston & Sampson in this report are based solely on the information reported in this document. Future subsurface investigations, sampling, and/or other information that was not available to Weston & Sampson at the time of the study, may result in a modification of the findings stated in this report.

Should additional information become available concerning this project site or neighboring properties, which could directly impact the Site in the future, that information should be made available to Weston & Sampson for review so that, if necessary, conclusions presented in this report may be modified.

The preceding recommendations should be considered preliminary, as actual soil conditions may vary. In order for our recommendations to be final, Weston & Sampson should be retained to observe actual subsurface conditions encountered during construction. Our observations will allow us to interpret actual conditions and adapt our recommendations if needed.

The conclusions of this report are based on project site conditions observed by Weston & Sampson personnel at the time of the study, information provided by the City of Peabody, and samples collected and analyzed on the dates shown or stated in this report. Any modification of the report without written verification or adaptation by Weston & Sampson, as appropriate for the specific purpose intended, will be at the City and MassEEA's sole risk and without liability or legal exposure to Weston & Sampson or to Weston & Sampson's consultants. Within the limitations of scope, schedule and budget, our services have been executed in accordance with the generally accepted practices in this area at the time this report was prepared. No warranty, expressed or implied, is given.

APPENDIX C  
MAPS



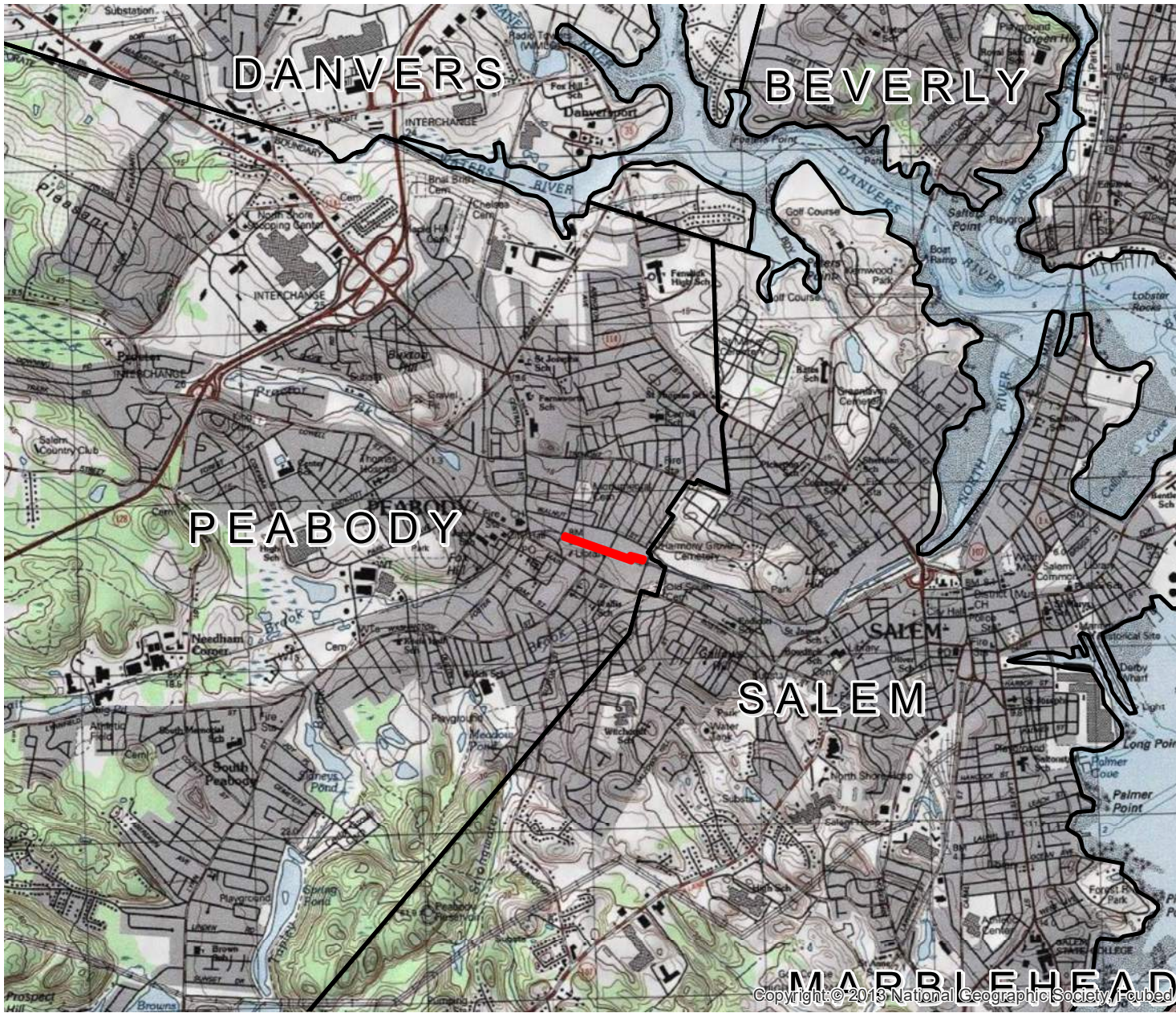

### Legend

 Work Area

**FIGURE 1**

Riverwalk  
Peabody, MA

Locus Map

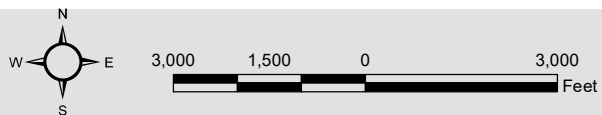

Data Source: Office of Geographic and Environmental Information (MassGIS),  
Commonwealth of Massachusetts Executive Office of Environmental Affairs



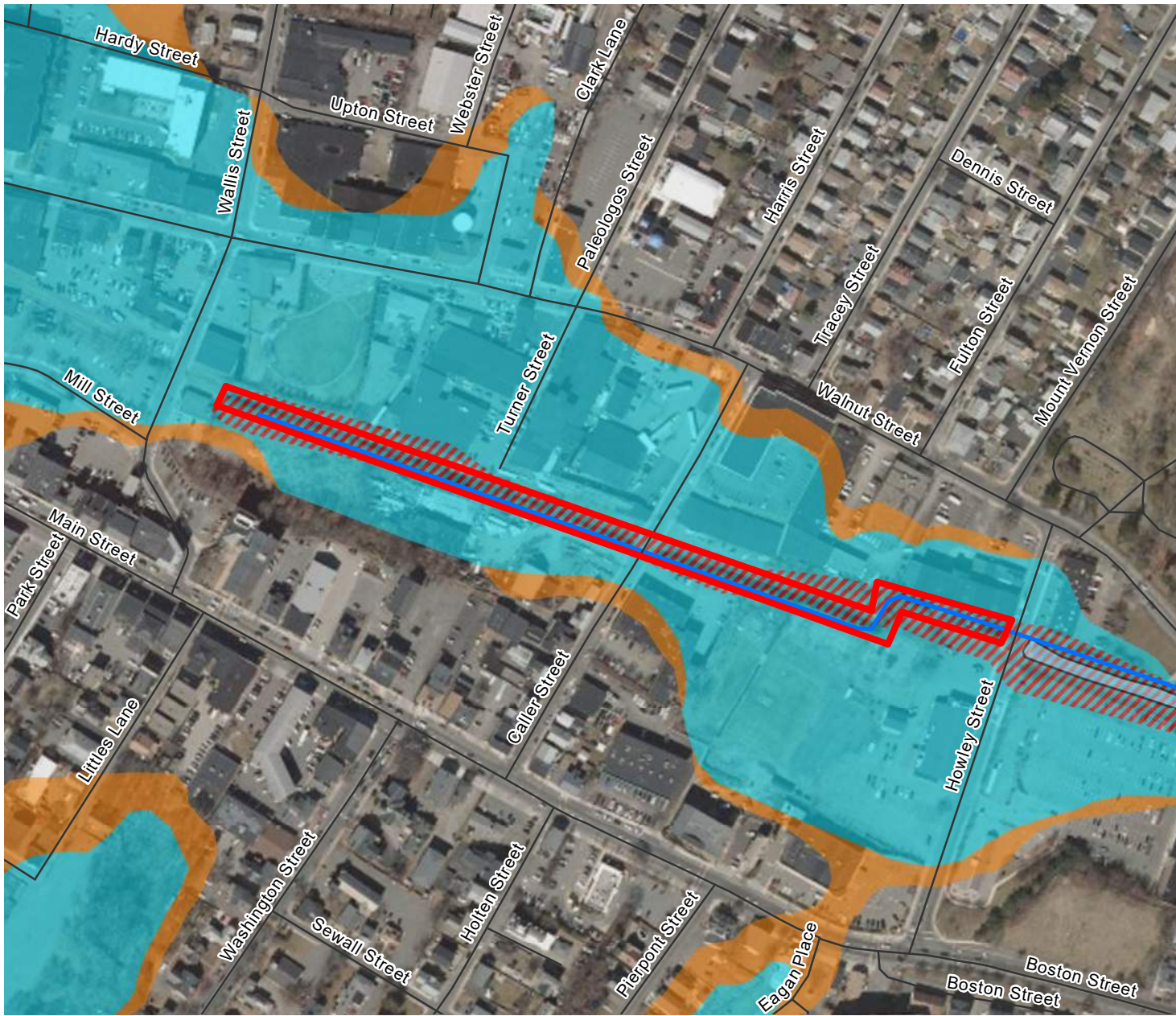

- Legend**
- Work Area
  - Perennial Stream
  - Intermittent Stream
  - Marsh/Bog
  - Wooded marsh
  - Cranberry Bog
  - Salt Marsh
  - Open Water
  - Reservoir (with PWSID)
  - Tidal Flats
  - Beach/Dune
  - ACECs
  - ACECs
  - NHESP Estimated Habitats of Rare Wildlife
  - NHESP Priority Habitats of Rare Species
  - NHESP Certified Vernal Pools
  - NHESP Potential Vernal Pools
  - FEMA National Flood Hazard Layer**
  - Flood Zone Designations**
  - A: 1% Annual Chance of Flooding, no BFE
  - AE: 1% Annual Chance of Flooding, with BFE
  - AE: Regulatory Floodway
  - AH: 1% Annual Chance of 1-3ft Ponding, with BFE
  - AO: 1% Annual Chance of 1-3ft Sheet Flow Flooding, with Depth
  - VE: High Risk Coastal Area
  - D: Possible But Undetermined Hazard
  - X: 0.2% Annual Chance of Flooding
  - X: Reduced Flood Risk due to Levee
  - Area Not Included
  - Area with no DFIRM - Paper FIRMs in Effect
  - Outstanding Resource Waters**
  - Public Water Supply Contributor
  - ORW for ACEC
  - ORW for both Water Supply and Other

**FIGURE 2**  
Riverwalk  
Peabody, MA

Environmental  
Resource Map

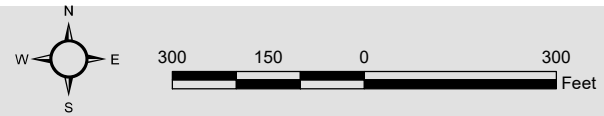

Data Source: Office of Geographic and Environmental Information (MassGIS), Commonwealth of Massachusetts Executive Office of Environmental Affairs





# National Flood Hazard Layer FIRMette



70°55'35"W 42°31'42"N

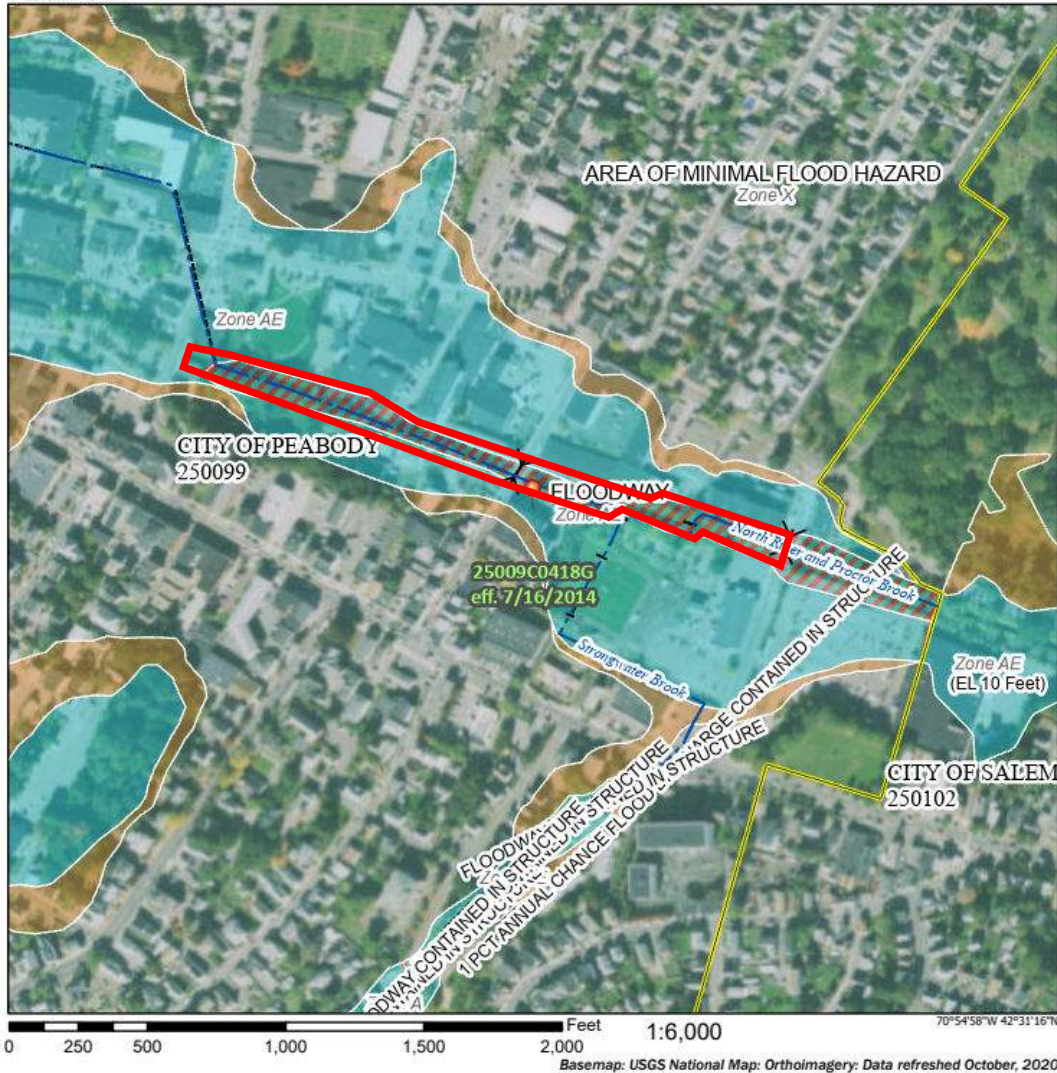

## Legend

SEE FIS REPORT FOR DETAILED LEGEND AND INDEX MAP FOR FIRM PANEL LAYOUT

SPECIAL FLOOD HAZARD AREAS		Without Base Flood Elevation (BFE) Zone A, V, A99
		With BFE or Depth Zone AE, AO, AH, VE, AR
		Regulatory Floodway
OTHER AREAS OF FLOOD HAZARD		0.2% Annual Chance Flood Hazard, Areas of 1% annual chance flood with average depth less than one foot or with drainage areas of less than one square mile Zone X
		Future Conditions 1% Annual Chance Flood Hazard Zone X
		Area with Reduced Flood Risk due to Levee. See Notes, Zone X
		Area with Flood Risk due to Levee Zone D
OTHER AREAS		NO SCREEN Area of Minimal Flood Hazard Zone X
		Effective LOMRs
		Area of Undetermined Flood Hazard Zone D
GENERAL STRUCTURES		Channel, Culvert, or Storm Sewer
		Levee, Dike, or Floodwall
OTHER FEATURES		Cross Sections with 1% Annual Chance Water Surface Elevation
		Coastal Transect
		Base Flood Elevation Line (BFE)
		Limit of Study
		Jurisdiction Boundary
		Coastal Transect Baseline
		Profile Baseline
	Hydrographic Feature	
MAP PANELS		Digital Data Available
		No Digital Data Available
		Unmapped

The pin displayed on the map is an approximate point selected by the user and does not represent an authoritative property location.

This map complies with FEMA's standards for the use of digital flood maps if it is not void as described below. The basemap shown complies with FEMA's basemap accuracy standards

The flood hazard information is derived directly from the authoritative NFHL web services provided by FEMA. This map was exported on 3/3/2021 at 12:31 PM and does not reflect changes or amendments subsequent to this date and time. The NFHL and effective information may change or become superseded by new data over time.

This map image is void if the one or more of the following map elements do not appear: basemap imagery, flood zone labels, legend, scale bar, map creation date, community identifiers, FIRM panel number, and FIRM effective date. Map images for unmapped and unmodernized areas cannot be used for regulatory purposes.

**FIGURE 3**  
Riverwalk  
Peabody, MA  
FEMA Map



APPENDIX D  
SPECS

SECTION 01562

DUST CONTROL

PART 1 - GENERAL

1.01 DESCRIPTION:

This section of the specification covers the control of dust via water, complete.

PART 2 - PRODUCTS

2.01 WATER:

- A. Water shall not be brackish and shall be free from oil, acid, and injurious alkali or vegetable matter.

PART 3 - EXECUTION

3.01 APPLICATION:

- A. Water may be sprinkler applied with equipment including a tank with gauge-equipped pressure pump and a nozzle-equipped spray bar.
- B. Water shall be dispersed through the nozzle under a minimum pressure of 20 pounds per square inch, gauge pressure.

END OF SECTION

\\wse03.local\WSE\Projects\MA\Peabody MA\MVP Action Grant 2019\Task 3 - Permitting\X - joint appendices\Appendix D - Specs\SECTION 01562-Dust Control.docx

## SECTION 01570

### ENVIRONMENTAL PROTECTION

#### PART 1 – GENERAL

##### 1.01 DESCRIPTION:

- A. The work covered by this section of the specifications consists of furnishing all labor, materials, tools and equipment and performing all work required for the prevention of environmental pollution during and as a result of construction operations under this contract.
- B. The requirements set forth in this section of the specifications apply to construction in and adjacent to wetlands, unless otherwise specifically stated.
- C. All work under this Contract shall be in accordance with the Conservation Commissions' Orders of Conditions as well as any conditional requirements applied
- D. Prior to commencement of work, the Contractor shall meet with representatives of the Engineer to develop mutual understandings relative to compliance of the environmental protection program.

##### 1.02 SUBMITTALS:

- A. The Contractor shall submit for approval six sets of details and literature fully describing environmental protection methods to be employed in carrying out construction activities within 100 feet of wetlands or across areas designated as wetlands.

#### PART 2 - PRODUCTS

##### 2.01 CATCH BASIN PROTECTION:

- A. To trap sediment and to prevent sediment from clogging drainage systems, catch basin protection in the form of a siltation sack (Siltsack as manufactured by ACF Environmental, Inc. or approved equal) shall be provided as approved by the Engineer.

##### 2.02 COMPOST FILTER TUBES:

- A. Silt socks shall be a tubular filter sock of mesh fabric. The fabric will have openings of between 1/8" to 1/4" diameter. The mesh material will either photo degrade within one year or be made of nylon with a life expectancy of 24 months. The sock shall be filled with a mix of composted leaf mulch, bark mulch and wood chips that have been composted for at least one year. The sock will have a minimum diameter of 12-inches.



### 2.03 EROSION CONTROL BLANKET:

- A. The erosion control blanket shall be completely biodegradable and constructed from spun jute yarns. The standard roll shall be 4' wide by 225' long and shall last approximately 6-9 months. The jute matting shall meet the following specifications.
- a. Mesh Size 11mm x 18mm
  - b. Water Absorption >450% of Fabric Weight
  - c. Thickness 0.25 inch
  - d. Recommended Shear Stress 0.45 lbs./ft<sup>2</sup>
  - e. Recommended Flow 6 fps
  - f. Recommended Slope 3:1
  - g. Coverage 100yd<sup>2</sup>/roll
  - h. Roll Weight 92 lbs
- B. Erosion control blanket shall be Jute Matting, manufactured by GEI Works, PO Box 780928, Sebastian, FL 32978, 772-646-0597, [www.geiworks.com](http://www.geiworks.com)

### 2.04 SILT CURTAIN:

- A. The silt curtain shall be a Type-1-Silt-Barrier consisting of 18-ounce vinyl fabric skirt with a 6-inch marine quality floatation device. The skirt shall be ballasted to hang vertical in the water column by a minimum 3/16-inch galvanized chain. The silt curtain shall extend into the water as shown on the drawings. If necessary, join adjacent ends of the silt curtain by connecting the reinforcing grommets and shackling ballast lines.

## PART 3- EXECUTION

### 3.01 NOTIFICATION AND STOPPAGE OF WORK:

- A. The Engineer will notify the Contractor in writing of any non-compliance with the provisions of the Order of Conditions. The Contractor shall, after receipt of such notice, immediately take corrective action. Such notice, when delivered to the Contractor or his authorized representative at the site of the work, shall be deemed sufficient for the purpose. If the Contractor fails to act promptly, the Owner may order stoppage of all or part of the work through the Engineer until satisfactory corrective action has been taken. No claim for an extension of time or for excess costs or damage incurred by the Contractor as a result of time lost due to any stop work orders shall be made unless it was later determined that the Contractor was in compliance.

### 3.02 AREA OF CONSTRUCTION ACTIVITY:

- A. Insofar as possible, the Contractor shall confine his construction activities to those areas defined by the plans and specifications. All land resources within the project boundaries and outside the limits of permanent work performed under this contract shall be preserved in their present condition or be restored to a condition after completion of construction at least equal to that which existed prior to work under this contract.

### 3.03 PROTECTION OF WATER RESOURCES:

- A. The Contractor shall not pollute streams, lakes or reservoirs with fuels, oils, bitumens, calcium chloride, acids or other harmful materials. It is the Contractor's responsibility to comply with all applicable Federal, State, County and Municipal laws regarding pollution of rivers and streams.
- B. Special measures should be taken to insure against spillage of any pollutants into public waters.

#### 3.04 CONSTRUCTION IN AREAS DESIGNATED AS WETLANDS ON THE DRAWINGS:

- A. Insofar as possible, the Contractor shall make every effort to minimize disturbance within areas designated as wetlands or within 100-feet of wetland resource areas.
- B. The Contractor shall perform his work in such a way that these areas are left in the condition existing prior to construction.
- C. The elevations of areas designated as wetlands shall not be unduly disturbed by the Contractor's operations.

#### 3.05 PROTECTING AND MINIMIZING EXPOSED AREAS:

- A. The Contractor shall limit the area of land which is exposed and free from vegetation during construction. In areas where the period of exposure will be greater than two (2) months, temporary vegetation, mulching or other protective measures shall be provided as specified.
- B. The Contractor shall take account of the conditions of the soil where temporary cover crop will be used to insure that materials used for temporary vegetation are adaptive to the sediment control. Materials to be used for temporary vegetation shall be approved by the Engineer.

#### 3.06 LOCATION OF STORAGE AREAS:

- A. The location of the Contractor's storage areas for equipment and/or materials shall be upon cleared portions of the job site or areas to be cleared as a part of this project, and shall require written approval of the Engineer. Plans showing storage facilities for equipment and materials shall be submitted for approval of the Engineer.
- B. No excavated materials or materials used in backfill operations shall be deposited within a minimum distance of one hundred (100) feet of any watercourse or any drainage facility. Adequate measures for erosion and sediment control such as the placement of baled straw or line of straw wattles or compost filter tubes around the downstream perimeter of stockpiles shall be employed to protect any downstream areas from siltation.
- C. There shall be no storage of equipment or materials in areas designated as wetlands.

- D. The Engineer may designate a particular area or areas where the Contractor may store materials used in his operations.

### 3.07 PROTECTION OF LANDSCAPE:

- A. The Contractor shall not deface, injure, or destroy trees or shrubs nor remove or cut them without written authority from the Owner. No ropes, cables, or guys shall be fastened to or attached to any existing nearby trees for anchorages unless specifically authorized by the Engineer. Excavating machinery and cranes shall be of suitable type and be operated with care to prevent injury to trees which are not to be removed, particularly overhanging branches and limbs. The Contractor shall, in any event, be responsible for any damage resulting from such use.
- B. Branches, limbs, and roots shall not be cut except by permission of the Engineer. All cutting shall be smoothly and neatly done without splitting or crushing. When there is unavoidable injury to branches, limbs and trunks of trees, the injured portions shall be neatly trimmed and covered with an application of grafting wax or tree healing paint as directed.
- C. Where, in the opinion of the Engineer, trees may possibly be defaced, bruised, injured, or otherwise damaged by the Contractor's equipment or by his blasting or other operations, the Engineer may require the Contractor to adequately protect such trees by placing boards, planks, poles or fencing around them. Any trees or landscape feature scarred or damaged by the Contractor's equipment or operations shall be restored as nearly as possible to its original condition at the expense of the Contractor. The Engineer will decide what method of restoration shall be used, and whether damaged trees shall be treated and healed or removed and disposed of under the provisions of Section 02230, CLEARING AND GRUBBING.
- D. Cultivated hedges, shrubs, and plants which could be injured by the Contractor's operations shall be protected by suitable means or shall be dug up, balled and temporarily replanted and maintained. After construction operations have been substantially completed, they shall be replanted in their original positions and cared for until growth is re-established. If cultivated hedges, shrubs, and plants are injured to such a degree as to affect their growth or diminish their beauty or usefulness, they shall be replaced by items of a kind and quality at least equal to that existing at the start of the work.

### 3.08 CLEARING AND GRUBBING:

- A. The Contractor shall clear and grub only on the Owner's land or the Owner's easements, and only the area required for construction operations, as approved by the Engineer. Removal of mature trees (4 inches or greater DBH) will not be allowed on temporary easements.
- B. The Contractor shall not remove trees in the Owner's temporary easements without permission of the Engineer.

### 3.09 DISCHARGE OF DEWATERING OPERATIONS:



- A. Under no circumstances shall the Contractor discharge water to the areas designated as wetlands. When constructing in a wetlands area, the Contractor shall discharge water from dewatering operations directly to the nearest drainage system, stream, or waterway after filtering by an approved method.
- B. The pumped water shall be filtered through filter fabric and baled straw, a vegetative filter strip or a vegetated channel to trap sediment occurring as a result of the construction operations. The vegetated channel shall be constructed such that the discharge flow rate shall not exceed a velocity of more than 1 foot per second. Accumulated sediment shall be cleared from the channel periodically.

### 3.10 DUST CONTROL:

- A. During the progress of the work, the Contractor shall conduct his operations and maintain the area of his activities, including sweeping and sprinkling of streets as necessary, to minimize creation and dispersion of dust. If the Engineer decides it is necessary to use calcium chloride for more effective dust control, the Contractor shall furnish and spread the material, as directed. Calcium chloride shall be as specified under Section 01562, DUST CONTROL.
- B. Calcium Chloride shall not be used for dust control within a drainage basin or in the vicinity of any source of potable water.

### 3.15 CATCH BASIN PROTECTION:

- A. Catch basin protection shall be used for every catch basin, shown on the plans or as required by the Engineer, to trap sediment and prevent it from clogging drainage systems and entering wetlands. Siltation sacks shall be securely installed under the catch basin grate. Care shall be taken to keep the siltation sacks from breaking apart or clogging. All deposited sediment shall be removed periodically and at times prior to predicted precipitation to allow free drainage flow. Prior to working in areas where catch basins are to be protected, each catch basin sump shall be cleaned of all debris and protected. The Contractor shall properly dispose of all debris at no additional cost to the Owner.

### 3.16 COMPOST FILTER TUBES:

- A. The filter tubes will be staked in the ground using wooden stakes driven at 4-foot intervals. The wooden stakes will be placed at a minimum depth of 24-inches into the ground.

### 3.17 EROSION CONTROL BLANKET:

- A. Mating rolls should be stored in their original, unopened packaging. The designated storage area should be level, dry, well-drained, stable, and should protect the product

- from precipitation, chemicals, standing water, excessive heat, ultraviolet radiation, vandalism, and animals.
- B. It is recommended that weed affected areas are sprayed with herbicide prior to mat installation. Excavate and trim slope to smooth profile, removing obstructions such as tree stumps or rubble and filling in any voids. Excavate anchor trenches along the top edge of the slope. Top soil is required to successfully grow grass and plants. Evenly spread top soil across the surface to required depth. All pre-seeding of the soil to be carried out prior to laying mat.
  - C. Dig a trench at the top of the slope, minimum depth of six (6) inches. Pin the end of the roll into the bottom of the trench. Back-fill the trench and roll the matting down the slope with a minimum overlap of four (4) inches.
  - D. See contract drawings for additional detail.

3.18 SILT CURTAIN:

- A. The silt curtain shall be a Type-1-Silt-Barrier consisting of 18-ounce vinyl fabric skirt with a 6-inch marine quality floatation device. The skirt shall be ballasted to hang vertical in the water column by a minimum 3/16-inch galvanized chain. The silt curtain shall extend into the water as shown on the drawings. If necessary, join adjacent ends of the silt curtain by connecting the reinforcing grommets and shackling ballast lines.

END OF SECTION

\\Wse03.local\WSE\Projects\MA\Peabody MA\MVP Action Grant 2019\Task 3 - Permitting\X - joint appendices\Appendix D - Specs\SECTION 01570 - Environmental Protection HIGGINS UPDATES.docx

## SECTION 01740

### CLEANING UP

#### PART 1 - GENERAL

##### 1.01 DESCRIPTION:

The Contractor must employ at all times during the progress of its work adequate cleanup measures and safety precautions to prevent injuries to persons or damage to property. The Contractor shall immediately, upon request by the Engineer provide adequate material, equipment and labor to cleanup and make safe any and all areas deemed necessary by the Engineer.

#### PART 2 - PRODUCTS

Not applicable

#### PART 3 - EXECUTION

##### 3.01 DAILY CLEANUP:

- A. The Contractor shall clean up, at least daily, all refuse, rubbish, scrap and surplus material, debris and unneeded construction equipment resulting from the construction operations and sweep the area. The site of the work and the adjacent areas affected thereby shall at all times present a neat, orderly and workmanlike appearance.
- B. Upon written notification by the Engineer, the Contractor shall within 24 hours clean up those areas, which in the Engineer's opinion are in violation of this section and the above referenced sections of the specifications.
- C. If in the opinion of the Engineer, the referenced areas are not satisfactorily cleaned up, all other work on the project shall stop until the cleanup is satisfactory.

##### 3.02 MATERIAL OR DEBRIS IN DRAINAGE FACILITIES:

- A. Where material or debris has washed or flowed into or has been placed in existing watercourses, ditches, gutters, drains, pipes, structures, such material or debris shall be entirely removed and satisfactorily disposed of during progress of the work, and the ditches, channels, drains, pipes, structures, and work shall, upon completion of the work, be left in a clean and neat condition.

##### 3.03 REMOVAL OF TEMPORARY BUILDINGS, STRUCTURES AND EQUIPMENT:

- A. On or before completion of the work, the Contractor shall, unless otherwise specifically required or permitted in writing, tear down and remove all temporary buildings and structures it built; shall remove all temporary works, tools and machinery or other construction



equipment it furnished; shall remove all rubbish from any grounds which it has occupied; shall remove erosion controls; and shall leave the roads and all parts of the property and adjacent property affected by its operations in a neat and satisfactory condition.

3.04 RESTORATION OF DAMAGED PROPERTY:

- A. The Contractor shall restore or replace, when and as required, any property damaged by its work, equipment or employees, to a condition at least equal to that existing immediately prior to the beginning of operations. To this end the Contractor shall do as required all necessary highway or driveway, walk and landscaping work. Materials, equipment, and methods for such restoration shall be as approved by the Engineer.

3.05 FINAL CLEANUP:

- A. Before acceptance by the Owner, the Contractor shall perform a final cleanup to bring the construction site to its original or specified condition. This cleanup shall include removing all trash and debris off of the premises. Before acceptance, the Engineer shall approve the condition of the site.

END OF SECTION

\\Wse03.local\WSE\Projects\MA\Peabody MA\MVP Action Grant 2019\Task 3 - Permitting\X - joint appendices\Appendix D - Specs\SECTION 01740-Cleaning Up.docx

APPENDIX E  
WETLANDS MEMO

# Wetland Delineation Report

April 2021

Peabody, Massachusetts  
Project # ENG20-0145

MVP Riverwalk  
Peabody, MA

Wetland Delineation Conducted By:  
Nathaniel Parker on 4/1/2021

Delineation Report Reviewed By:  
Mel Higgins, PWS





## TABLE OF CONTENTS

	Page
1.0 SITE DESCRIPTION .....	1-1
2.0 DELINEATION OF WETLAND RESOURCES .....	2-1
2.1 Site Observations .....	2-1
2.2 Bank .....	2-1
2.3 Other Protected Areas .....	2-2
3.0 SUMMARY .....	3-1
4.0 REFERENCES .....	4-1

## FIGURES

Figure 1 .....	Wetlands Field Map
Figure 2 .....	USGS Topographic Map
Figure 3 .....	FEMA FIRM Map
Figure 4 .....	Environmental Resources Map

## APPENDICES

Appendix A .....	Site Photographs
------------------	------------------

## 1.0 SITE DESCRIPTION

On April 1st, 2021, the presence of wetland resources was investigated near Proctor Brook in Peabody, MA. This investigation area is located in a predominantly urban/industrial area. Please see Figure 1 (Wetlands Field Map) and Figure 2 (USGS Topographic Map) of this report for the investigation area.

Wetland resource areas including a perennial stream were identified and flagged in the field using pink flagging by a Weston & Sampson employee who is trained in the wetland delineation process using the Massachusetts Department of Environmental Protection (MassDEP) and the US Army Corps of Engineers methodology. A further description of these wetland resource areas is presented in the following sections.

## 2.0 DELINEATION OF WETLAND RESOURCES

### 2.1 Site Observations

The Weston & Sampson wetland scientist, trained in the ACOE Wetland Delineation Manual and Massachusetts Department of Environmental Protection (MassDEP) Delineating Bordering Vegetated Wetlands Under the Massachusetts Wetland Protection Act guidance document, observed the following protected wetland resources at the site:

- Bank – Perennial Stream

Field data were recorded on US Army Corps of Engineers (ACOE) Wetland Determination Data Forms. See Appendix A for site photographs.

### 2.2 Bank

Water bodies, including perennial streams, intermittent streams, ponds and lakes, have banks which are protected by the Massachusetts Wetland Protection Act. Bank is a wetland resource area defined by 310 CMR 10.54(2)(a) as “the portion of land surface which normally abuts and confines a water body. It occurs between a waterbody and a vegetated bordering wetland and adjacent floodplain, or, in absence of these, it occurs between a waterbody and an upland.” Vegetated banks provide valuable functions such as flood control, stormwater prevention, fisheries protection, and water quality protection. The limit of this resource area is identified by Top of Bank (TOB) which is located at the first observable break in slope or the Mean Annual Flood Level (MAFL), whichever is lower. TOB is easily identified in the field so that indicator was utilized for this wetland delineation.

#### Perennial Stream Banks

A single perennial stream known as Proctor Brook was identified within the investigation area. The boundary of the perennial stream was identified in the field utilizing Top of Bank (TOB), identified by flag line TOB-A. Proctor Brook is shown as perennial on the current United States Geographical Survey (USGS) map and has a watershed size greater than 0.5 square miles in size according to USGS Stream Stats which classifies the stream as perennial per 310 CMR 10.58 (2)(a)(1)(b-c). The boundary of the



perennial stream was identified in the field by the first observable break in slope (TOB). Wetland flags left in the field included:

- TOB-A1 through TOB-A23 (Perennial Stream Bank "A" Series)

Perennial streams are subject to a 200-foot Riverfront Area under the Massachusetts Wetland Protection Act per 301 CMR 10.58(2)(a)(2)(c).

### 2.3 Other Protected Areas

Weston & Sampson created environmental resources maps (see Figure 4) of the site to determine the presence of other protected areas. The data source of these map layers was the Massachusetts Geographic Information System (MassGIS). These areas included:

- NHESP Priority Habitats of Rare Species
- NHESP Estimated Habitats of Rare Wildlife
- NHESP Certified and Potential Vernal Pools
- Areas of Critical Environmental Concern (ACEC)
- Outstanding Resource Waters (ORW)

Wetland resources identified in the field were also added to these maps. Based on the MassGIS information there are no protected areas other than the Perennial Stream resource area previously identified above.

Based on the information provided by the FIRM map the investigational area is located within a Regulatory Floodway. FEMA defines a Regulatory Floodway as "the channel of a river or other watercourse and the adjacent land areas that must be reserved in order to discharge the base flood without cumulatively increasing the water surface elevation more than a designated height." This Regulatory Floodway is located within Zone AE, which is the 100-year flood zone. As a result, the investigation is located within the 100-year flood zone.

## 3.0 SUMMARY

On April 1<sup>st</sup> 2021, the presence of wetland resources was investigated near Proctor Brook in Peabody, MA. A single perennial stream was identified and flagged at the site.

Additional environmental mapping was conducted using MassGIS data layers and FEMA FIRM mapping. This additional mapping indicates that the investigation area falls within the 100-year floodzone.

This Wetlands Delineation Report has been reviewed and approved by a Professional Wetland Scientist PWS.

---

#### 4.0 REFERENCES

- Jackson, Scott. 1995. "Delineating Bordering Vegetated Wetlands Under the Massachusetts Wetlands Protection Act." Massachusetts Department of Environmental Protection.
- Massachusetts Division of Fisheries and Wildlife, Natural Heritage and Endangered Species Program. Massachusetts Natural Heritage Atlas, 13th Edition with 2017 web updates. Accessed on 4/5/2021
- Massachusetts Geographic Information System. January 2009. Outstanding Resource Waters. Massachusetts Department of Environmental Protection. Accessed on 4/5/2021
- Massachusetts Geographic Information System. December 2003. Areas of Critical Environmental Concern. Massachusetts Department of Environmental Protection. Accessed on 4/5/2021
- Newcomb, Lawrence. 1977. Newcomb's Wildflower Guide. Little, Brown and Company.
- Web Soil Survey of Essex County, Massachusetts. United States Department of Agriculture, Soil Conservation Service, in cooperation with Massachusetts Agricultural Experiment Station
- United States Department of Agriculture, Natural Resources Conservation Service. 2018. *Field Indicators of Hydric Soils in the United States, Version 8.2*. L. M. Vasilas, G. W. Hurt, and J.F. Berkowitz (eds.). USDA, NRCS, in cooperation with the National Technical Committee for Hydric Soils.
- USACOE, January 1987, Corps of Engineers Wetlands Delineation Manual, Wetlands Research Program Technical Report Y-87-1.
- FEMA Flood Map Service Center, online at [msc.fema.gov/portal](https://msc.fema.gov/portal) Assessed on 4/5/2021
- Tiner, Jr., Ralph W., 2005, Field Guide to Nontidal Wetland Identification
- Tiner, Jr., Ralph W, 2009, Field Guide to Tidal Wetland Plants of the Northeastern United States and Neighboring Canada.
- Wojtec, Michael, Bard – A field Guide to Trees of the Northeast.
- New England Hydric Soils Technical Committee, 2019, Version 4, *Field Indicator of Identifying Hydric Soils in New England*. New England Interstate Water Pollution Control Commission, Lowell, MA.





**Legend**

-  Perennial Stream
-  Investigation Area
-  Marsh/Bog
-  Wooded marsh
-  Cranberry Bog
-  Salt Marsh
-  Open Water
-  Reservoir (with PWSID)
-  Tidal Flats
-  Beach/Dune

**FIGURE 1**

MVP Riverwalk  
Peabody, MA

Wetland Field Map

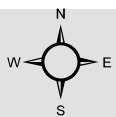

Data Source: Office of Geographic and Environmental Information (MassGIS),  
Commonwealth of Massachusetts Executive Office of Environmental Affairs





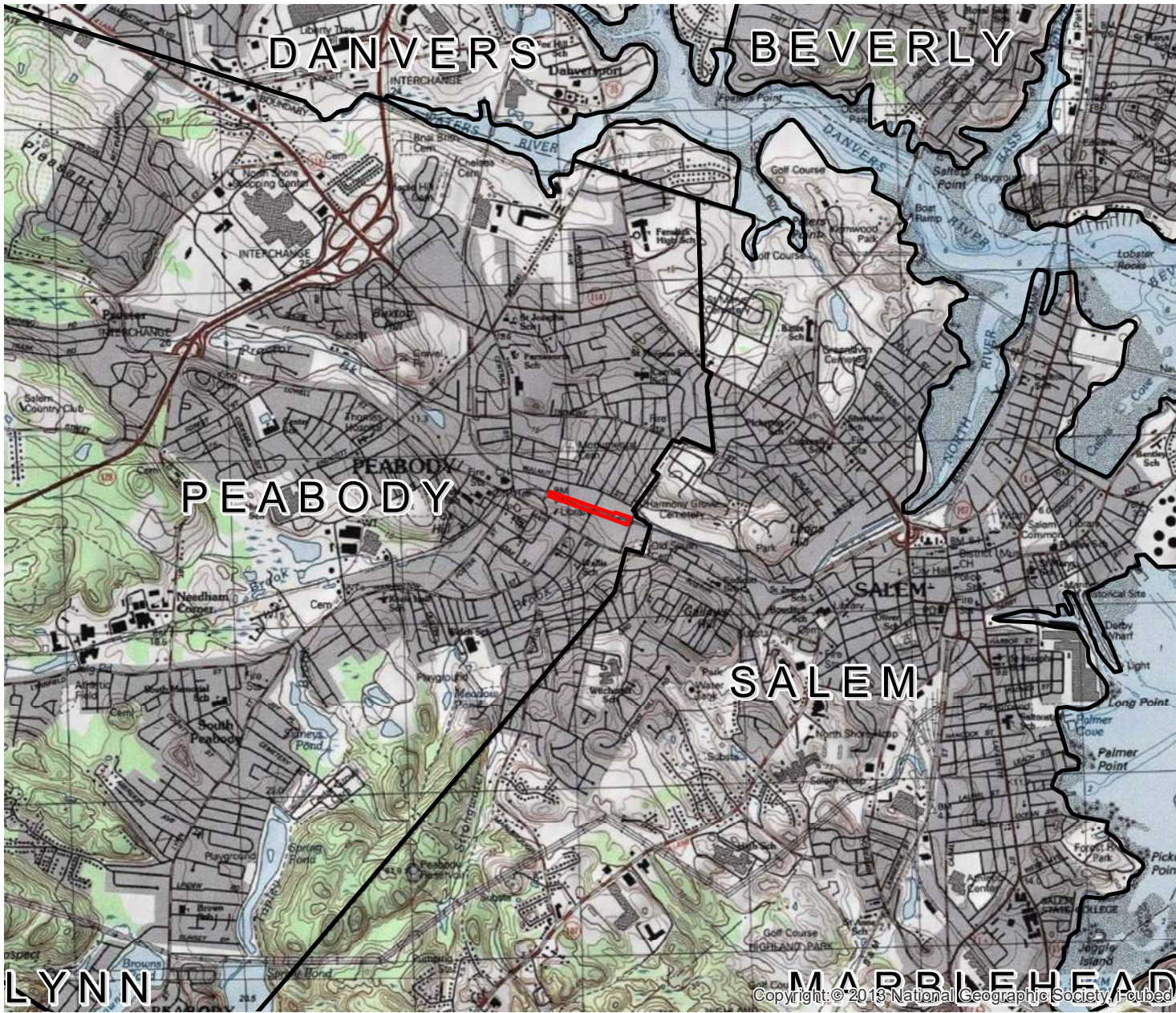

**Legend**

 Investigation Area

**FIGURE 2**

MVP Riverwalk  
Peabody, MA

Locus Map

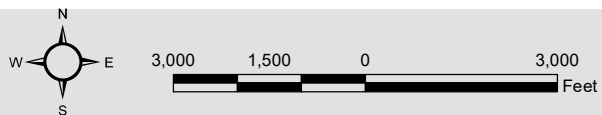





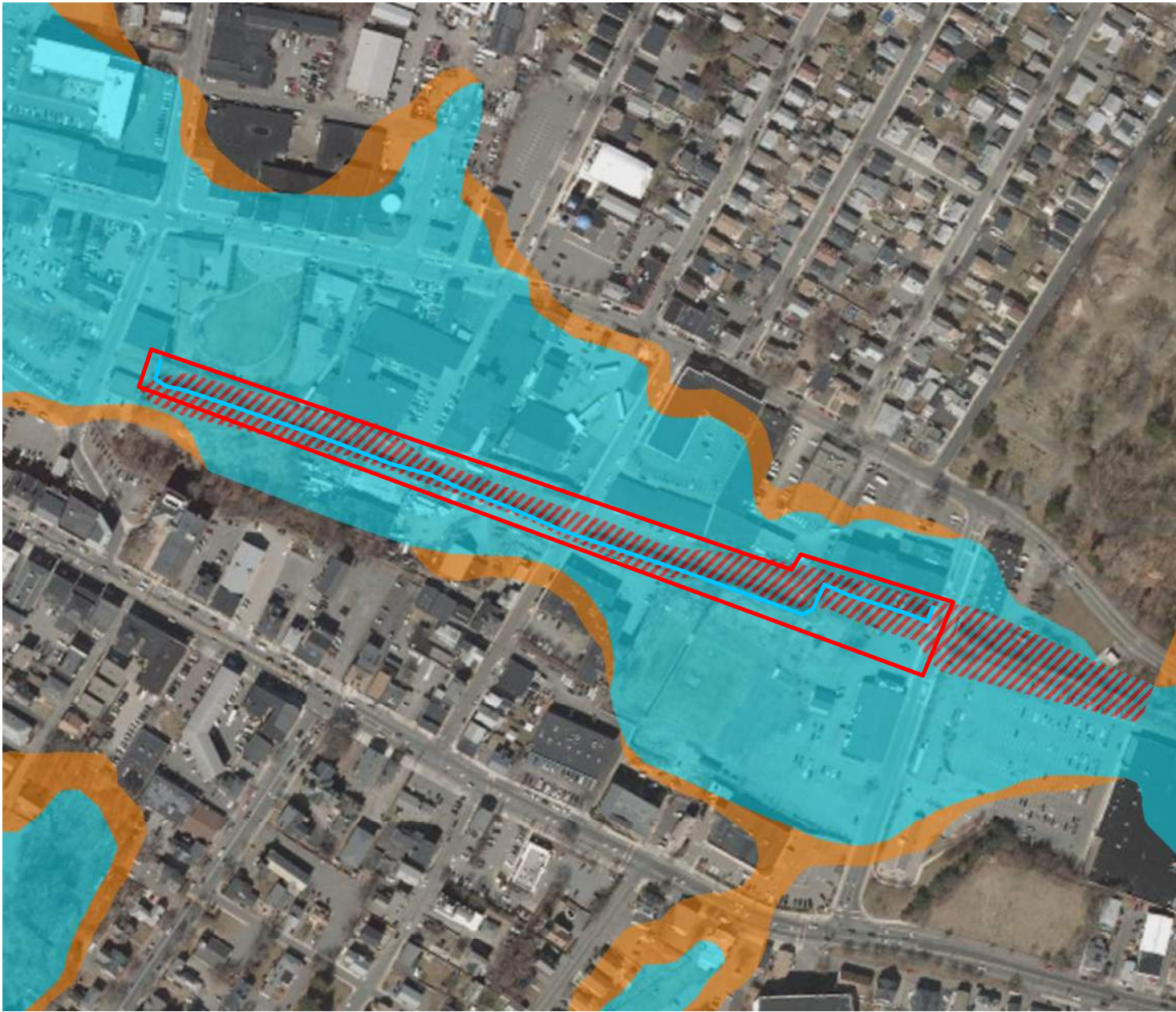







Data Source: Office of Geographic and Environmental Information (MassGIS),  
Commonwealth of Massachusetts Executive Office of Environmental Affairs





**Legend**

-  Perennial Stream
-  Investigation Area
- FEMA National Flood Hazard Layer**
- Flood Zone Designations**
-  A: 1% Annual Chance of Flooding, no BFE
-  AE: 1% Annual Chance of Flooding, with BFE
-  AE: Regulatory Floodway
-  AH: 1% Annual Chance of 1-3ft Ponding, with BFE
-  AO: 1% Annual Chance of 1-3ft Sheet Flow Flooding, with Depth
-  VE: High Risk Coastal Area
-  D: Possible But Undetermined Hazard
-  X: 0.2% Annual Chance of Flooding
-  X: Reduced Flood Risk due to Levee
-  Area Not Included
-  Area with no DFIRM - Paper FIRMs in Effect

**FIGURE 3**

MVP Riverwalk  
Peabody, MA

FEMA Map

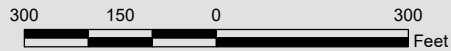
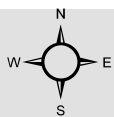









Data Source: Office of Geographic and Environmental Information (MassGIS),  
Commonwealth of Massachusetts Executive Office of Environmental Affairs







**Legend**

-  Perennial Stream
-  Investigation Area
- ACECs**
-  ACECs
- NHESP Habitats**
-  NHESP Estimated Habitats of Rare Wildlife
-  NHESP Priority Habitats of Rare Species
-  NHESP Certified Vernal Pools
-  NHESP Potential Vernal Pools
- Outstanding Resource Waters**
-  Public Water Supply Contributor
-  ORW for ACEC
-  ORW for both Water Supply and Other

**FIGURE 4**

MVP Riverwalk  
Peabody, MA

Environmental  
Resource Map

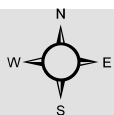

Data Source: Office of Geographic and Environmental Information (MassGIS),  
Commonwealth of Massachusetts Executive Office of Environmental Affairs



## APPENDIX A

### Site Photographs





Photo 1: Proctor Brook



APPENDIX F  
PHOTOS

Riverwalk  
Peabody, MA





Riverwalk  
Peabody, MA





APPENDIX G  
STORMWATER REPORT



# Checklist for Stormwater Report

## A. Introduction

**Important:** When filling out forms on the computer, use only the tab key to move your cursor - do not use the return key.



A Stormwater Report must be submitted with the Notice of Intent permit application to document compliance with the Stormwater Management Standards. The following checklist is NOT a substitute for the Stormwater Report (which should provide more substantive and detailed information) but is offered here as a tool to help the applicant organize their Stormwater Management documentation for their Report and for the reviewer to assess this information in a consistent format. As noted in the Checklist, the Stormwater Report must contain the engineering computations and supporting information set forth in Volume 3 of the [Massachusetts Stormwater Handbook](#). The Stormwater Report must be prepared and certified by a Registered Professional Engineer (RPE) licensed in the Commonwealth.

The Stormwater Report must include:

- The Stormwater Checklist completed and stamped by a Registered Professional Engineer (see page 2) that certifies that the Stormwater Report contains all required submittals.<sup>1</sup> This Checklist is to be used as the cover for the completed Stormwater Report.
- Applicant/Project Name
- Project Address
- Name of Firm and Registered Professional Engineer that prepared the Report
- Long-Term Pollution Prevention Plan required by Standards 4-6
- Construction Period Pollution Prevention and Erosion and Sedimentation Control Plan required by Standard 8<sup>2</sup>
- Operation and Maintenance Plan required by Standard 9

In addition to all plans and supporting information, the Stormwater Report must include a brief narrative describing stormwater management practices, including environmentally sensitive site design and LID techniques, along with a diagram depicting runoff through the proposed BMP treatment train. Plans are required to show existing and proposed conditions, identify all wetland resource areas, NRCS soil types, critical areas, Land Uses with Higher Potential Pollutant Loads (LUHPPL), and any areas on the site where infiltration rate is greater than 2.4 inches per hour. The Plans shall identify the drainage areas for both existing and proposed conditions at a scale that enables verification of supporting calculations.

As noted in the Checklist, the Stormwater Management Report shall document compliance with each of the Stormwater Management Standards as provided in the Massachusetts Stormwater Handbook. The soils evaluation and calculations shall be done using the methodologies set forth in Volume 3 of the Massachusetts Stormwater Handbook.

To ensure that the Stormwater Report is complete, applicants are required to fill in the Stormwater Report Checklist by checking the box to indicate that the specified information has been included in the Stormwater Report. If any of the information specified in the checklist has not been submitted, the applicant must provide an explanation. The completed Stormwater Report Checklist and Certification must be submitted with the Stormwater Report.

<sup>1</sup> The Stormwater Report may also include the Illicit Discharge Compliance Statement required by Standard 10. If not included in the Stormwater Report, the Illicit Discharge Compliance Statement must be submitted prior to the discharge of stormwater runoff to the post-construction best management practices.

<sup>2</sup> For some complex projects, it may not be possible to include the Construction Period Erosion and Sedimentation Control Plan in the Stormwater Report. In that event, the issuing authority has the discretion to issue an Order of Conditions that approves the project and includes a condition requiring the proponent to submit the Construction Period Erosion and Sedimentation Control Plan before commencing any land disturbance activity on the site.



# Checklist for Stormwater Report

---

## B. Stormwater Checklist and Certification

The following checklist is intended to serve as a guide for applicants as to the elements that ordinarily need to be addressed in a complete Stormwater Report. The checklist is also intended to provide conservation commissions and other reviewing authorities with a summary of the components necessary for a comprehensive Stormwater Report that addresses the ten Stormwater Standards.

*Note:* Because stormwater requirements vary from project to project, it is possible that a complete Stormwater Report may not include information on some of the subjects specified in the Checklist. If it is determined that a specific item does not apply to the project under review, please note that the item is not applicable (N.A.) and provide the reasons for that determination.

A complete checklist must include the Certification set forth below signed by the Registered Professional Engineer who prepared the Stormwater Report.

---

### Registered Professional Engineer's Certification

I have reviewed the Stormwater Report, including the soil evaluation, computations, Long-term Pollution Prevention Plan, the Construction Period Erosion and Sedimentation Control Plan (if included), the Long-term Post-Construction Operation and Maintenance Plan, the Illicit Discharge Compliance Statement (if included) and the plans showing the stormwater management system, and have determined that they have been prepared in accordance with the requirements of the Stormwater Management Standards as further elaborated by the Massachusetts Stormwater Handbook. I have also determined that the information presented in the Stormwater Checklist is accurate and that the information presented in the Stormwater Report accurately reflects conditions at the site as of the date of this permit application.

Registered Professional Engineer Block and Signature

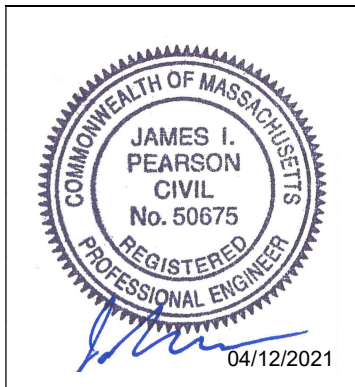

  
Signature and Date

4/12/2021

---

## Checklist

**Project Type:** Is the application for new development, redevelopment, or a mix of new and redevelopment?

- New development
- Redevelopment
- Mix of New Development and Redevelopment





# Checklist for Stormwater Report

---

## Checklist (continued)

**LID Measures:** Stormwater Standards require LID measures to be considered. Document what environmentally sensitive design and LID Techniques were considered during the planning and design of the project:

- No disturbance to any Wetland Resource Areas
- Site Design Practices (e.g. clustered development, reduced frontage setbacks)
- Reduced Impervious Area (Redevelopment Only)
- Minimizing disturbance to existing trees and shrubs
- LID Site Design Credit Requested:
  - Credit 1
  - Credit 2
  - Credit 3
- Use of "country drainage" versus curb and gutter conveyance and pipe
- Bioretention Cells (includes Rain Gardens)
- Constructed Stormwater Wetlands (includes Gravel Wetlands designs)
- Treebox Filter
- Water Quality Swale
- Grass Channel
- Green Roof
- Other (describe): \_\_\_\_\_

### Standard 1: No New Untreated Discharges

- No new untreated discharges
- Outlets have been designed so there is no erosion or scour to wetlands and waters of the Commonwealth
- Supporting calculations specified in Volume 3 of the Massachusetts Stormwater Handbook included.



# Checklist for Stormwater Report

---

## Checklist (continued)

### Standard 2: Peak Rate Attenuation

- Standard 2 waiver requested because the project is located in land subject to coastal storm flowage and stormwater discharge is to a wetland subject to coastal flooding.
- Evaluation provided to determine whether off-site flooding increases during the 100-year 24-hour storm.
- Calculations provided to show that post-development peak discharge rates do not exceed pre-development rates for the 2-year and 10-year 24-hour storms. If evaluation shows that off-site flooding increases during the 100-year 24-hour storm, calculations are also provided to show that post-development peak discharge rates do not exceed pre-development rates for the 100-year 24-hour storm.

### Standard 3: Recharge

- Soil Analysis provided.
- Required Recharge Volume calculation provided.
- Required Recharge volume reduced through use of the LID site Design Credits.
- Sizing the infiltration, BMPs is based on the following method: Check the method used.
  - Static
  - Simple Dynamic
  - Dynamic Field<sup>1</sup>
- Runoff from all impervious areas at the site discharging to the infiltration BMP.
- Runoff from all impervious areas at the site is *not* discharging to the infiltration BMP and calculations are provided showing that the drainage area contributing runoff to the infiltration BMPs is sufficient to generate the required recharge volume.
- Recharge BMPs have been sized to infiltrate the Required Recharge Volume.
- Recharge BMPs have been sized to infiltrate the Required Recharge Volume *only* to the maximum extent practicable for the following reason:
  - Site is comprised solely of C and D soils and/or bedrock at the land surface
  - M.G.L. c. 21E sites pursuant to 310 CMR 40.0000
  - Solid Waste Landfill pursuant to 310 CMR 19.000
  - Project is otherwise subject to Stormwater Management Standards only to the maximum extent practicable.
- Calculations showing that the infiltration BMPs will drain in 72 hours are provided.
- Property includes a M.G.L. c. 21E site or a solid waste landfill and a mounding analysis is included.

---

<sup>1</sup> 80% TSS removal is required prior to discharge to infiltration BMP if Dynamic Field method is used.



# Checklist for Stormwater Report

---

## Checklist (continued)

### Standard 3: Recharge (continued)

- The infiltration BMP is used to attenuate peak flows during storms greater than or equal to the 10-year 24-hour storm and separation to seasonal high groundwater is less than 4 feet and a mounding analysis is provided.
- Documentation is provided showing that infiltration BMPs do not adversely impact nearby wetland resource areas.

### Standard 4: Water Quality

The Long-Term Pollution Prevention Plan typically includes the following:

- Good housekeeping practices;
  - Provisions for storing materials and waste products inside or under cover;
  - Vehicle washing controls;
  - Requirements for routine inspections and maintenance of stormwater BMPs;
  - Spill prevention and response plans;
  - Provisions for maintenance of lawns, gardens, and other landscaped areas;
  - Requirements for storage and use of fertilizers, herbicides, and pesticides;
  - Pet waste management provisions;
  - Provisions for operation and management of septic systems;
  - Provisions for solid waste management;
  - Snow disposal and plowing plans relative to Wetland Resource Areas;
  - Winter Road Salt and/or Sand Use and Storage restrictions;
  - Street sweeping schedules;
  - Provisions for prevention of illicit discharges to the stormwater management system;
  - Documentation that Stormwater BMPs are designed to provide for shutdown and containment in the event of a spill or discharges to or near critical areas or from LUHPPL;
  - Training for staff or personnel involved with implementing Long-Term Pollution Prevention Plan;
  - List of Emergency contacts for implementing Long-Term Pollution Prevention Plan.
- A Long-Term Pollution Prevention Plan is attached to Stormwater Report and is included as an attachment to the Wetlands Notice of Intent.
  - Treatment BMPs subject to the 44% TSS removal pretreatment requirement and the one inch rule for calculating the water quality volume are included, and discharge:
    - is within the Zone II or Interim Wellhead Protection Area
    - is near or to other critical areas
    - is within soils with a rapid infiltration rate (greater than 2.4 inches per hour)
    - involves runoff from land uses with higher potential pollutant loads.
  - The Required Water Quality Volume is reduced through use of the LID site Design Credits.
  - Calculations documenting that the treatment train meets the 80% TSS removal requirement and, if applicable, the 44% TSS removal pretreatment requirement, are provided.





# Checklist for Stormwater Report

---

## Checklist (continued)

### Standard 4: Water Quality (continued)

- The BMP is sized (and calculations provided) based on:
  - The ½" or 1" Water Quality Volume or
  - The equivalent flow rate associated with the Water Quality Volume and documentation is provided showing that the BMP treats the required water quality volume.
- The applicant proposes to use proprietary BMPs, and documentation supporting use of proprietary BMP and proposed TSS removal rate is provided. This documentation may be in the form of the propriety BMP checklist found in Volume 2, Chapter 4 of the Massachusetts Stormwater Handbook and submitting copies of the TARP Report, STEP Report, and/or other third party studies verifying performance of the proprietary BMPs.
- A TMDL exists that indicates a need to reduce pollutants other than TSS and documentation showing that the BMPs selected are consistent with the TMDL is provided.

### Standard 5: Land Uses With Higher Potential Pollutant Loads (LUHPPLs)

- The NPDES Multi-Sector General Permit covers the land use and the Stormwater Pollution Prevention Plan (SWPPP) has been included with the Stormwater Report.
- The NPDES Multi-Sector General Permit covers the land use and the SWPPP will be submitted **prior to** the discharge of stormwater to the post-construction stormwater BMPs.
- The NPDES Multi-Sector General Permit does **not** cover the land use.
- LUHPPLs are located at the site and industry specific source control and pollution prevention measures have been proposed to reduce or eliminate the exposure of LUHPPLs to rain, snow, snow melt and runoff, and been included in the long term Pollution Prevention Plan.
- All exposure has been eliminated.
- All exposure has **not** been eliminated and all BMPs selected are on MassDEP LUHPPL list.
- The LUHPPL has the potential to generate runoff with moderate to higher concentrations of oil and grease (e.g. all parking lots with >1000 vehicle trips per day) and the treatment train includes an oil grit separator, a filtering bioretention area, a sand filter or equivalent.

### Standard 6: Critical Areas

- The discharge is near or to a critical area and the treatment train includes only BMPs that MassDEP has approved for stormwater discharges to or near that particular class of critical area.
- Critical areas and BMPs are identified in the Stormwater Report.



# Checklist for Stormwater Report

---

## Checklist (continued)

### Standard 7: Redevelopments and Other Projects Subject to the Standards only to the maximum extent practicable

- The project is subject to the Stormwater Management Standards only to the maximum Extent Practicable as a:
  - Limited Project
  - Small Residential Projects: 5-9 single family houses or 5-9 units in a multi-family development provided there is no discharge that may potentially affect a critical area.
  - Small Residential Projects: 2-4 single family houses or 2-4 units in a multi-family development with a discharge to a critical area
  - Marina and/or boatyard provided the hull painting, service and maintenance areas are protected from exposure to rain, snow, snow melt and runoff
- Bike Path and/or Foot Path
- Redevelopment Project
- Redevelopment portion of mix of new and redevelopment.
- Certain standards are not fully met (Standard No. 1, 8, 9, and 10 must always be fully met) and an explanation of why these standards are not met is contained in the Stormwater Report.
- The project involves redevelopment and a description of all measures that have been taken to improve existing conditions is provided in the Stormwater Report. The redevelopment checklist found in Volume 2 Chapter 3 of the Massachusetts Stormwater Handbook may be used to document that the proposed stormwater management system (a) complies with Standards 2, 3 and the pretreatment and structural BMP requirements of Standards 4-6 to the maximum extent practicable and (b) improves existing conditions.

### Standard 8: Construction Period Pollution Prevention and Erosion and Sedimentation Control

A Construction Period Pollution Prevention and Erosion and Sedimentation Control Plan must include the following information:

- Narrative;
  - Construction Period Operation and Maintenance Plan;
  - Names of Persons or Entity Responsible for Plan Compliance;
  - Construction Period Pollution Prevention Measures;
  - Erosion and Sedimentation Control Plan Drawings;
  - Detail drawings and specifications for erosion control BMPs, including sizing calculations;
  - Vegetation Planning;
  - Site Development Plan;
  - Construction Sequencing Plan;
  - Sequencing of Erosion and Sedimentation Controls;
  - Operation and Maintenance of Erosion and Sedimentation Controls;
  - Inspection Schedule;
  - Maintenance Schedule;
  - Inspection and Maintenance Log Form.
- A Construction Period Pollution Prevention and Erosion and Sedimentation Control Plan containing the information set forth above has been included in the Stormwater Report.



# Checklist for Stormwater Report

---

## Checklist (continued)

### Standard 8: Construction Period Pollution Prevention and Erosion and Sedimentation Control (continued)

- The project is highly complex and information is included in the Stormwater Report that explains why it is not possible to submit the Construction Period Pollution Prevention and Erosion and Sedimentation Control Plan with the application. A Construction Period Pollution Prevention and Erosion and Sedimentation Control has **not** been included in the Stormwater Report but will be submitted **before** land disturbance begins.
- The project is **not** covered by a NPDES Construction General Permit.
- The project is covered by a NPDES Construction General Permit and a copy of the SWPPP is in the Stormwater Report.
- The project is covered by a NPDES Construction General Permit but no SWPPP been submitted. The SWPPP will be submitted BEFORE land disturbance begins.

### Standard 9: Operation and Maintenance Plan

- The Post Construction Operation and Maintenance Plan is included in the Stormwater Report and includes the following information:
  - Name of the stormwater management system owners;
  - Party responsible for operation and maintenance;
  - Schedule for implementation of routine and non-routine maintenance tasks;
  - Plan showing the location of all stormwater BMPs maintenance access areas;
  - Description and delineation of public safety features;
  - Estimated operation and maintenance budget; and
  - Operation and Maintenance Log Form.
- The responsible party is **not** the owner of the parcel where the BMP is located and the Stormwater Report includes the following submissions:
  - A copy of the legal instrument (deed, homeowner's association, utility trust or other legal entity) that establishes the terms of and legal responsibility for the operation and maintenance of the project site stormwater BMPs;
  - A plan and easement deed that allows site access for the legal entity to operate and maintain BMP functions.

### Standard 10: Prohibition of Illicit Discharges

- The Long-Term Pollution Prevention Plan includes measures to prevent illicit discharges;
- An Illicit Discharge Compliance Statement is attached;
- NO Illicit Discharge Compliance Statement is attached but will be submitted **prior to** the discharge of any stormwater to post-construction BMPs.



**Stormwater Report**  
To Be Submitted with the Notice of Intent

Applicant/Project Name: City of Peabody

Project Address: Wallis/Howley Street, Peabody

Application Prepared by:

Firm:	Weston & Sampson, Inc.
Registered PE	James Pearson, P.E.

Below is an explanation concerning Standards 1-10 as they apply to the City of Peabody MVP Riverwalk Project:

**General:**

In 2018, the City of Peabody (the City) was awarded a Municipal Vulnerability Preparedness (MVP) Action Grant by the Massachusetts Executive Office of Energy & Environmental Affairs (MassEEA). The MVP grant will allow the City to explore options for improving the flood resiliency of Peabody Square and was awarded based on a comprehensive project proposal to specifically target a stretch of the North River Canal that will improve flood resilience, address site contamination from historic use as a tannery district and evaluate a park resource and Riverwalk that would enhance public access and vitality of the area.

The proposed Riverwalk will be approximately 1,600 feet in length, following along the canal in the urban industrial section of downtown Peabody from approximately Wallis Street to Howley Street. Part of the project's scope of work includes replacing the south canal wall with a new wall at a lower elevation with a stabilized slope with a turf reinforcement mat and vegetation.

**Standard 1: No New Untreated Discharges**

The proposed project will create no new untreated discharges. A 6,000 square foot existing building at 24 Caller Street was removed recently prior to the start of this project and is being replaced with vegetated park space. The only proposed impervious area as part of this project will be a bike and pedestrian path. A vegetated buffer will be provided between the pathway and the River. The path is not expected to generate any significant pollutant load, and the vegetative buffer will be adequate for whatever incidental treatment may be required.

**Standard 2: Peak Rate Attenuation**

There will be a net increase in impervious area. When factoring in the building removal, the net increase is 3,000 square feet, all consisting of pathway. Due to the proximity of the pathway to the river, lack of land space and high groundwater elevations, the installation of stormwater detention BMPs is not feasible. A vegetated buffer is being provided between the pathway and the river which will slow runoff to the maximum extent practicable.

To ensure that the work incorporates the performance standards recommended in the DEP's Stormwater Management Policy, necessary erosion and sedimentation control measures will be utilized during construction. These measures are described in the erosion and sediment control plans for the project.

### **Standard 3: Recharge**

As noted in the **Standard 2** explanation, there will be a net increase in impervious area at the site. Existing soil conditions preclude the installation of recharge BMPs. Geotechnical explorations performed in November 2018 showed static groundwater elevations at depths of 2-5 feet below ground surface. Seasonal high groundwater elevations are expected to be higher, to within a few inches of the ground surface. All observed water surface elevations occur within a layer of urban fill of varying quality that would likewise render it unsuitable for siting a recharge BMP.

### **Standard 4: Water Quality**

Due to the site limitations described above, coupled with the negligible pollutant load expected from a pathway, water quality treatment has been addressed only to the maximum extent practicable. Water quality treatment for runoff from the pathway will be accomplished by means of sheet flow from the pathway through a vegetated strip between the pathway and the river.

### **Standard 5: Land Uses with Higher Potential Pollutant Loads (LUHPPLs)**

Not Applicable. There are no LUHPPLs in the work area.

### **Standard 6: Critical Areas**

There will be no new discharge to critical areas.

### **Standard 7: Redevelopments and Other Projects Subject to the Standards Only to the Maximum Extent Practicable**

This is a redevelopment and limited project

### **Standard 8: Construction Period Pollution Prevention and Erosion and Sediment Control**

A detailed Construction Period Pollution Prevention and Erosion and Sedimentation Control Plan is included. To ensure that the work incorporates the performance standards recommended in the DEP's Stormwater Management Policy, necessary erosion and sedimentation control measures will be utilized during construction. These measures will include compost filter tubes, silt fencing and a stabilized construction entrance, as depicted on the site plans.

### **Standard 9: Operation and Maintenance Plan**

An operations and maintenance plan is not needed since there will not be any new stormwater management systems put in place in the project work area.

### Standard 10: Prohibition of Illicit Discharges

By the nature of the proposed work, there will be no illicit discharges. There will be no opportunity for illicit discharges into the system.



Registered Professional Engineer's Certification

I have reviewed the Stormwater Report, including any relevant soil evaluations, computations, Long-term Pollution Prevention Plan, the Construction Period Erosion and Sedimentation Control Plan, the Long-term Post-Construction Operation and Maintenance Plan, the Illicit Discharge Compliance Statement and the plans showing the stormwater management system, and have determined that they have been prepared in accordance with the requirements of the Stormwater Management Standards as further elaborated by the Massachusetts Stormwater Handbook. I have also determined that the information presented in the Stormwater Checklist is accurate and that the information presented in the Stormwater Report accurately reflects conditions at the site as of the date of this permit application.

Registered Professional Engineer Block and Signature

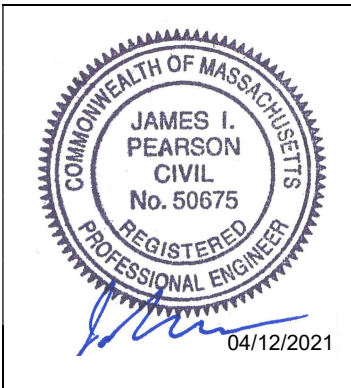

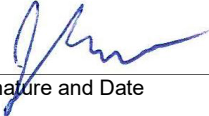
 4/12/2021  
\_\_\_\_\_  
Signature and Date

# Construction Period Pollution Prevention and Erosion and Sedimentation Control Plan

## SECTION 1: Introduction

In 2018, the City of Peabody (the City) was awarded a Municipal Vulnerability Preparedness (MVP) Action Grant by the Massachusetts Executive Office of Energy & Environmental Affairs (MassEEA). The MVP grant will allow the City to explore options for improving the flood resiliency of Peabody Square and was awarded based on a comprehensive project proposal to specifically target a stretch of the North River Canal that will improve flood resilience, address site contamination from historic use as a tannery district and evaluate a park resource and Riverwalk that would enhance public access and vitality of the area.

The proposed Riverwalk will be approximately 1,600 feet in length, following along the canal in the urban industrial section of downtown Peabody from approximately Wallis Street to Howley Street. Part of the project's scope of work includes replacing the south canal wall with a new wall at a lower elevation with a stabilized slope with a turf reinforcement mat and vegetation.

As part of this project, this "Construction Period Pollution Prevention and Erosion and Sedimentation Control Plan" has been created to ensure that no further disturbance to the wetland resource is created during the project.

## SECTION 2: Construction Period Pollution Prevention Measures

Best Management Practices (BMPs) will be utilized as Construction Period Pollution Prevention Measures to reduce potential pollutants and prevent any off-site discharge. The objectives of the BMPs for construction activity are to minimize the disturbed areas, stabilize any disturbed areas, control the site perimeter and retain sediment. Both erosion and sedimentation controls and non-stormwater best management measures will be used to minimize site disturbance and ensure compliance with the performance standards of the WPA and Stormwater Standards. Measures will be taken to minimize the area disturbed by construction activities to reduce the potential for soil erosion and stormwater pollution problems. In addition, good housekeeping measures will be followed for the day-to-day operation of the construction site under the control of the contractor to minimize the impact of construction. This section describes the control practices that will be in place during construction activities. Recommended control practices will comply with the standards set in the MA DEP Stormwater Policy Handbook.

### **2.1 Minimize Disturbed Area and Protect Natural Features and Soil**

In order to minimize disturbed areas, work will be completed within well-defined work limits. These work limits are shown on the construction plans. The Contractor shall not disturb native vegetation in the undisturbed wetland area without prior approval from the Engineer. The Contractor will be responsible to make sure that all of their workers and any subcontractors know the proper work limits and do not extend their work into the undisturbed areas. The protective measures are described in more detail in the following sections.

### **2.2 Control Stormwater Flowing onto and through the project**

Construction areas adjacent to wetland resources will be lined with appropriate sediment and erosion control measures. Both the silt curtain and compost filter tubes will be inspected daily for sediment build-up and accumulated silt will be removed as needed.

### **2.3 Stabilize Soils**

The Contractor shall limit the area of land which is exposed and free from vegetation during construction. In areas where the period of exposure will be greater than two (2) months, mulching, the use of erosion control mats, or other protective measures shall be provided as specified.

The Contractor shall take account of the conditions of the soil where erosion control seeding will take place to insure that materials used for re-vegetation are adaptive to the sediment control.

### **2.4 Proper Storage and Cover of Any Stockpiles**

The location of the Contractor's storage areas for equipment and/or materials shall require written approval of the Engineer.

Adequate measures for erosion and sediment control such as the placement of compost filter tubes around the downstream perimeter of stockpiles shall be employed to protect any downstream areas from siltation.

There shall be no storage of equipment or materials in areas designated as wetlands.

The Engineer may designate a particular area or areas where the Contractor may store materials used in his operations.

### **2.5 Perimeter Controls and Sediment Barriers**

Erosion control lines as described in Section 5 will be utilized to ensure that sedimentation does not occur outside the perimeter of the work area.

### **2.6 Storm Drain Inlet Protection**

Storm drain inlet protection will be used when necessary.

### **2.7 Retain Sediment On-Site**

The Contractor will be responsible to monitor erosion control measures. Whenever necessary the Contractor will clear sediment from the compost filter tube and silt curtain that have been silted up during construction. Daily monitoring should be conducted using the attached Monitoring Form. The following good housekeeping practices will be followed on-site during the construction project:

### **2.8 Material Handling and Waste Management**

Materials stored on-site will be stored in a neat, orderly manner in appropriate containers. Materials will be kept in their original containers with the original manufacturer's label. Substances will not be mixed with one another unless recommended by the manufacturer.



Waste materials will be collected and stored in a securely lidded metal container from a licensed management company. The waste and any construction debris from the site will be hauled off-site daily and disposed of properly. The contractor will be responsible for waste removal. Manufacturer's recommendations for proper use and disposal will be followed for materials. Sanitary waste will be collected from the portable units a minimum of once a week, by a licensed sanitary waste management contractor.

## **2.9 Designated Washout Areas**

The Contractor shall use washout facilities at their own facilities, unless otherwise directed by the Engineer.

## **2.10 Proper Equipment/Vehicle Fueling and Maintenance Practices**

On-site vehicles will be monitored for leaks and receive regular preventative maintenance to reduce the risk of leakage. To ensure that leaks on stored equipment do not contaminate the site, oil-absorbing mats will be placed under oil-containing equipment during storage. Regular fueling and service of the equipment may be performed using approved methods and with care taken to minimize chance of spills. Repair of equipment or machinery within the 100' water resources area shall not be allowed without the prior approval of the Engineer. Any petroleum products will be stored in tightly sealed containers that are clearly labeled with spill control pads/socks placed under/around their perimeters.

## **2.11 Equipment/Vehicle Washing**

The Contractor will be responsible to ensure that no equipment is washed on-site.

## **SECTION 3: Spill Prevention and Control Plan**

The Contractor will be responsible for preventing spills in accordance with the project specifications and applicable federal, state and local regulations. The Contractor will identify a properly trained site employee, involved with the day-to-day site operations to be the spill prevention and cleanup coordinator. The name(s) of the responsible spill personnel will be posted on-site. Each employee will be instructed that all spills are to be reported to the spill prevention and cleanup coordinator.

### **3.1 Spill Control Equipment**

Spill control/containment equipment will be kept in the Work Area. Materials and equipment necessary for spill cleanup will be kept either in the Work Area or in an otherwise accessible on-site location. Equipment and materials will include, but not be limited to, absorbent booms/mats, brooms, dust pans, mops, rags, gloves, goggles, sand, plastic and metal containers specifically for this purpose. It is the responsibility of the Contractor to ensure the inventory will be readily accessible and maintained.

### **3.2 Notification**

Workers will be directed to inform the on-site supervisor of a spill event. The supervisor will assess the incident and initiate proper containment and response procedures immediately upon notification. Workers should avoid direct contact with spilled materials during the containment procedures. Primary notification of a spill should be made to the local Fire Department and Police Departments. Secondary Notification will be to the certified cleanup contractor if deemed necessary by Fire and/or Police personnel. The third level of notification (within 1 hour) is to the DEP or municipality's Licensed Site Professional (LSP). The specific cleanup contractor to be used will be identified by the Contractor prior to commencement of construction activities.

### **3.3 Spill Containment and Clean-Up Measures**

Spills will be contained with granular sorbent material, sand, sorbent pads, booms or all of the above to prevent spreading. Certified cleanup contractors should complete spill cleanup. The material manufacturer's recommended methods for spill cleanup will be clearly posted and on-site personnel will be made aware of the procedures and the location of the information and cleanup supplies.

### **3.4 Hazardous Materials Spill Report**

The Contractor will report and record any spill. The spill report will present a description of the release, including the quantity and type of material, date of the spill, circumstances leading to the release, location of spill, response actions and personnel, documentation of notifications and corrective measures implemented to prevent reoccurrence.

This document does not relieve the Contractor of the Federal reporting requirements of 40 CFR Part 110, 40 CFR Part 117, 40 CFR Part 302 and the State requirements specified under the Massachusetts Contingency Plan (M.C.P) relating to spills or other releases of oils or hazardous substances. Where a release containing a hazardous substance or oil in an amount equal to or in excess of a reportable quantity established under either 40 CFR Part 110, 40 CFR Part 117 or 40 CFR Part 302, occurs during a twenty-four (24) hour period, the Contractor is required to comply with the response requirements of the above mentioned regulations. Spills of oil or hazardous material in excess of the reportable quantity will be reported to the National Response Center (NRC).

## **SECTION 4: Contact Information/Responsible Parties**

### **Owner/Operator:**

City of Peabody  
Brendan Callahan  
24 Lowell Street  
Peabody MA 01960  
978-538-5780  
Brendan.callahan@peabody-ma.gov

**Engineer:**

James Pearson, PE  
Weston & Sampson Engineers, Inc.  
55 Walkers Brook Dr, Suite 100  
Reading, MA 01867  
978-532-1900 ex. 2346

**Site Inspector:**

TBD

**Contractor:**

TBD

SECTION 5: Erosion and Sedimentation Control

Erosion and Sedimentation Control Drawings can be found in the attached project plans. In addition a technical specification (***Section 01570 Environmental Protection***) has been included as part of Appendix D, which details all Erosion and Sedimentation controls.

SECTION 6: Site Development Plan

The Site Development Plan is included in the attached plans.

SECTION 7: Operation and Maintenance of Erosion Control

The erosion control measures will be installed as detailed in the technical specification ***01570 Environmental Protection***. If there is a failure to the controls the Contractor, under the supervision of the Engineer, will be required to stop work until the failure is repaired.

Periodically throughout the work, whenever the Engineer deems it necessary, the sediment that has been deposited against the controls will be removed to ensure that the controls are working properly.

SECTION 8: Inspection Schedule

During construction, the erosion and sedimentation controls will be inspected daily. Once the Contractor is selected, an onsite inspector will be selected to work closely with the Engineer to ensure that erosion and sedimentation controls are in place and working properly. An Inspection Form is included.



**Construction Period Pollution Prevention and Erosion and Sedimentation Control Plan**

Peabody MVP Riverwalk

Inspection Form

Inspected By: \_\_\_\_\_ Date: \_\_\_\_\_ Time: \_\_\_\_\_

YES	NO	DOES NOT APPLY	ITEM
			Do any erosion/siltation control measures require repair or clean out to maintain adequate function?
			Is there any evidence that sediment is leaving the site and entering the wetlands?
			Are any temporary soil stockpiles or construction materials located in non-approved areas?
			Are on-site construction traffic routes, parking, and storage of equipment and supplies located in areas not specifically designed for them?

Specific location, current weather conditions, and action to be taken:

---

---

---

---

---

Other Comments:

---

---

Pending the actions noted above I certify that the site is in compliance with the Construction Period Pollution Prevention and Erosion and Sedimentation Control Plan.

Signature: \_\_\_\_\_ Date: \_\_\_\_\_

APPENDIX H  
ABUTTER INFORMATION



City of Peabody  
**Conservation Commission**

City Hall • 24 Lowell Street • Peabody, Massachusetts 01960 • Tel. 978-538-5900

**AFFIDAVIT OF SERVICE**

**Under the Massachusetts Wetlands Protection Act & Peabody's Local Ordinance Chapter 32-Wetlands and River Protection Regulations**

I, Alexandra Gaspar (on behalf of the City of Peabody) hereby certify under the pains  
(Applicants/owner's name)

and penalties of perjury that on [redacted] I gave notification to abutters in  
(date)

compliance with the second paragraph of the Massachusetts General Laws, Chapter 131, Section 40, the DEP Guide to Abutter Notification and Peabody's Local Ordinance Chapter 32-Wetlands and Rivers Protection Regs. Article IV § 32-16 in connection with the following matter:

A(n) Notice of Intent application was filed under the Massachusetts Wetlands Protection Act and the City of Peabody Wetlands & Rivers Protection Ordinance by

the City of Peabody with the Peabody Conservation Commission on  
name

[redacted] for a property located at  
date

Wallis St/Howley St area.

Property location

The form of notification and the list of abutters to whom it was given and their addresses are attached to this Affidavit of Service.

Signature

[redacted]

Date



**NOTIFICATION TO ABUTTERS UNDER THE  
MASSACHUSETTS WETLANDS PROTECTION ACT AND/OR CHAPTER 32 THE  
CITY OF PEABODY'S LOCAL WETLANDS AND RIVERS PROTECTION ACT**

In accordance with the second paragraph of Massachusetts General Laws, Chapter 131, Section 40 and/or Chapter 32 the City of Peabody's Local Wetlands and Rivers Protection Act, you are hereby notified of the following:

1. The name of the applicant is:  
City of Peabody
2. The applicant has filed a Notice of Intent with the Conservation Commission.
3. The address of the proposed activity is:  
from approximately Wallis Street to Howley Street
4. The proposed activity is:  
a new 1,600 foot riverwalk
5. Copies of the (CIRCLE ONE) ~~Notice of Intent~~ **Request for Determination of Applicability/Abbreviated Notice of Intent/Abbreviated Notice Resource Area Delineation** may be **examined only** in the Community Development Department, Conservation Commission Office, City Hall, 24 Lowell St., Peabody, MA between the hours of 8:30 am to 4 p.m., Monday, Tuesday, Wednesday; 8:30 to 7 p.m. Thursday and 8:30 to 12:30 on Friday (with the exception of lunch).
6. Copies of the **NOI/RDA/ANRAD/ANOI** may be obtained from the applicant by calling:  
978-548-4238
7. Information regarding the date and time of the public hearing may be obtained from the Commission Office at 978-538-5782.

NOTE: Notice of the public hearing including the date, time and place, will be published in the local paper, ex. (Shoppers Weekly New, Lynn Item, Peabody Citizen, Salem News) at least five (5) days in advance of the hearing.

NOTE: Notice of public hearing, including the date, time and place will be posted in City Hall by the Clerk's Office not less than forty-eight (48) hours in advance.

NOTE: You may contact your local Conservation Commission or the Department of Environmental Protection (DEP) for more information about this application of the Wetlands Protection Act. To contact DEP, call:

Northeast Region: 978-694-3200

**PROPOSED MEETING DATE:** May 19, 2021

All meetings are in the **Conference Room at the Department of Public Services 50 Farm Avenue Peabody MA** and start time is 7PM unless otherwise noted.



**City of Peabody**  
**CERTIFICATION OF ABUTTERS**

DATE: 6/16/21

PROPERTY OWNER: City of Peabody  
PROPERTY LOCATION: Proctor Brook MAP: Multiple LOT: Multiple  
REQUESTED BY: Alexandra Gasper PHONE: 978-548-4238

- Chapter 138, Section 15A – direct abutters & churches, synagogues, hospitals, & schools within 500'
- Chapter 40A, Section 11 – abutter to abutter within 300'
- Special Permit  Variance  Entertainment License  Site Plan Review
- Chapter 41, Section 81T – Notice of Submission of Plan – direct abutters
- Chapter 32, City of Peabody Code – Wetlands & Rivers Protection Regulations – abutter to abutter within 300'
- Chapter 131, Section 40 – Notice of Intent – all abutters within 100'
- 700 CMR 3.06, State Permits for billboard signs – Notification within 500'

*Please allow up to 5 business days for the completion of your request.*

Subject 86-142A

See Attached List

Teresa R. Reed  
BOARD OF ASSESSORS  
CITY OF PEABODY  
John F. Carmello

6/16/21

CERTIFIED

Property ID	Owner	Owner 2	Owner Address	Owner Address 2
086-142A	CITY OF PEABODY		24 LOWELL ST	PEABODY, MA 01960
085-033	SKOURAS WILLIAM J TRUSTEE	W J SKOURAS REALTY TRUST	170 REAR LYNN ST	PEABODY, MA 01960
085-034	SKOURAS WILLIAM J TRUSTEE	W J SKOURAS REALTY TRUST	13 MASON ST	PEABODY, MA 01960
085-035	PETRADELIS JOHN TRUSTEE	PETRADELIS REALTY TRUST	3 NEWTON DR	PEABODY, MA 01960
085-036	DESALVO CJ/JW & DC TRUSTEES	C/O CENTURY TIRE	53 WALNUT ST	PEABODY, MA 01960
085-037	CITY OF PEABODY	PARK	24 LOWELL ST	PEABODY, MA 01960
085-038	AEGEAN HOLDINGS LLC	C/O ZION ALAN	P O BOX 246	LYNNFIELD, MA 01940
085-039X	ZION REALTY CORP		12 BUTTONWOOD LN	IPSWICH, MA 01938
085-041	PORTER E H CONSTRUCTION INC		P.O. BOX 708	PEABODY, MA 01960
085-041A	DIMAMBRO ALFRED JR TRUSTEE	REGENCY REALTY TRUST	P.O. BOX 708	PEABODY, MA 01960
085-042	CITY OF PEABODY		24 LOWELL ST	PEABODY, MA 01960
085-043	BURNETT NORMAN S & DAVID S		PO BOX 409	PEABODY, MA 01960
085-072	CITY OF PEABODY	PEABODY INSTITUTE LIBRARY	24 LOWELL ST	PEABODY, MA 01960
085-072B	VALERA JUAN & THERESA		2 APPLETON ST	LYNN, MA 01902
085-073	KNIGHTS OF COLUMBUS		96 MAIN ST	PEABODY, MA 01960
085-075	A & A PROPERTIES LLC		98 MAIN ST	PEABODY, MA 01960
085-075A	MACDONALD WILLIAM S & TRACEY E		98 MAIN ST (R)	PEABODY, MA 01960
085-076	100R MAIN LLC		78 MILL ST	MIDDLETON, MA 01949
085-077	PHU JASON T & JUDY		22 SYMONDS ST	SALEM, MA 01970
085-078	KEVRAY 108 MAIN LLC		106 MAIN ST	PEABODY, MA 01960
085-079	KEVRAY 108 MAIN LLC		106 MAIN ST	PEABODY, MA 01960
085-080	116 MAIN STREET LLC		P.O. BOX 365	EAST HAMPSTEAD, NH 03826
085-082	BERUBE JOHN T & LENA L TRS	BERUBE PEABODY MAIN RLTY TRST	66 COUNTY WAY EXT	BEVERLY, MA 01915
085-083	KOKORAS NICHOLAS & GEORGE TRS	CALLER STREET TRUST	80 WASHINGTON ST - APT 1B	PEABODY, MA 01960
086-130X	NL GROCERY I EXCHANGE LLC	NL GROCERY I DST	P.O. BOX 3666	OAK BROOK, IL 60522
086-135	MERLINA A J & A B TRUSTEES	A & A HOWLEY ST REALTY TRUST	27 HOWLEY ST	PEABODY, MA 01960
086-136	FLOMP PATRICIA TRUSTEE	26 HOWLEY STREET TRUST	50 BROAD STREET	SALEM, MA 01970
086-137	FLOMP PATRICIA TRUSTEE	26 HOWLEY STREET TRUST	50 BROAD STREET	SALEM, MA 01970
086-138	77 WALNUT STREET LLC		300 ANDOVER ST - SUITE 372	PEABODY, MA 01960
086-140X	119 REAR FOSTER STREET LLC		PO BOX 606	PEABODY, MA 01960
086-141	27 CALLER STREET LLC		120 HARVARD ST	MALDEN, MA 02148
086-142	BOSTON CHIMNEY & TOWER CO INC		P O BOX 272	PEABODY, MA 01960
086-142B	E VICTORY PROPERTIES LLC		3 HICKORY LN	TOPSFIELD, MA 01983
086-143	BOSTON CHIMNEY & TOWER CO INC		P O BOX 272	PEABODY, MA 01960
086-144	KOKORAS GEORGE & NICHOLAS TRUSTEES	CALLER STREET TRUST	80 WASHINGTON ST - APT 1B	PEABODY, MA 01960
086-145	KOKORAS NICHOLAS & GEORGE TRS	CALLER STREET TRUST	80 WASHINGTON ST - APT 1B	PEABODY, MA 01960
086-149	KOKORAS NICHOLAS & GEORGE TRS	CALLER STREET TRUST	80 WASHINGTON ST - APT 1B	PEABODY, MA 01960
086-150	AZOREAN BROTHERHOOD OF THE	DIVINE HOLY GHOST INC	20 HOWLEY ST	PEABODY, MA 01960
086-150A	RIVERWALK PLACE LLC	C/O BIBBY REAL ESTATE CORP	PO BOX 110	LYNN, MA 01903
086-151X	RIVER DEVELOPMENT LLC		21 CALLER ST - SUITE 1	PEABODY, MA 01960
086-155	PATEL MAHAVIR & ARVIND TRUSTEES	KARM REALTY TRUST II	42 STILLMAN RD	LYNNFIELD, MA 01940
086-162	THE AZOREAN BROTHERHOOD OF THE	DIVINE HOLY GHOST INC C/O PINTO MARIO	11 HINGSTON ST	PEABODY, MA 01960
086-600	S & PO REALTY LLC		116 RANTOUL ST - #301	BEVERLY, MA 01915
086-601	PITZI JENNIFER L & MARK	JOHANSSON JOSEPH	118 SYLVAN ST	DANVERS, MA 01923
086-602	GRIECO MATTHEW C & MELISSA L		14 WYMON WAY	LYNNFIELD, MA 01940
086-603	PIKE CONNOR SCOTT		75 WALNUT ST - UNIT 104	PEABODY, MA 01960
086-604	JCG INVESTMENTS LLC		1 CENTRAL ST - SUITE 203	MIDDLETON, MA 01949
086-605	KOLA IRENE & ALEKSANDER		61 CASTLE CIR	PEABODY, MA 01960



Property ID	Owner	Owner 2	Owner Address	Owner Address 2
086-606	SNYDER GLENN		75 WALNUT ST - UNIT 107	PEABODY, MA 01960
086-607	GACEVIC ADIS		75 WALNUT ST - UNIT 108	PEABODY, MA 01960
086-608	BODINAKU ROVENA		177 MAIN ST - UNIT C	PEABODY, MA 01960
086-609	AMORIM JOSE M		75 WALNUT ST - UNIT 110	PEABODY, MA 01960
086-610	CAIN EDWARD MICHAEL		75 WALNUT ST - UNIT 111	PEABODY, MA 01960
086-611	BRACE MORGAN THOMPSON		75 WALNUT ST - UNIT 112	PEABODY, MA 01960
086-612	SILVA KATIA REGINA & MARTINS D'JORGE	MARTINS GUILHERME	75 WALNUT ST - UNIT 113	PEABODY, MA 01960
086-613	PRASETIOWATI SUTJI		75 WALNUT ST - UNIT 114	PEABODY, MA 01960
086-614	LIMA GEORGE M & LISETE M		75 WALNUT ST UNIT - 115	PEABODY, MA 01960
086-615	FORBES KAREN M &	ELLIOTT JONATHAN E	2 MCDEWELL AVE - APT 16	DANVERS, MA 01923
086-616	MANCUSO NICHOLAS &	CULLITY COLLEEN	75 WALNUT ST - UNIT 201	PEABODY, MA 01960
086-617	ZUPPIO ANTHONY TRUSTEE	ZUPPIO FAMILY TRUST	75 WALNUT ST - UNIT 202	PEABODY, MA 01960
086-618	LOUANAS NOUREDINE		75 WALNUT ST - UNIT 203	PEABODY, MA 01960
086-619	ZENG JIA XI & LIU YUCI		75 WALNUT ST - UNIT 204	PEABODY, MA 01960
086-620	KIPE SHPRESA & PAMELA		75 WALNUT ST - UNIT 205	PEABODY, MA 01960
086-621	GRIECO MATTHEW C & MELISSA L		14 WYMON WAY	LYNNFIELD, MA 01940
086-622	GIUFFRIDA CASSANDRA		14 DOANE AVE	BEVERLY, MA 01915
086-623	MCLAUGHLIN CHERYL		75 WALNUT ST - UNIT 208	PEABODY, MA 01960
086-624	COLLINS MARK S		37 LEDGEMONT LN	LYNN, MA 01904
086-625	HADSALL WILLIAM S		75 WALNUT ST - UNIT 210	PEABODY, MA 01960
086-626	NAKO ROBERT		119 ELLIOTT ST	DANVERS, MA 01923
086-627	KUDZMA MARGARET		75 WALNUT ST - UNIT 212	PEABODY, MA 01960
086-628	BABIC SEMSUDIN & EMIINA		75 WALNUT ST - UNIT 213	PEABODY, MA 01960
086-629	YORK IRENE COTONI		75 WALNUT ST - UNIT 214	PEABODY, MA 01960
086-630	JAWORSKI BARBARA C		75 WALNUT ST UNIT 215	PEABODY, MA 01960
086-631	DE OLIVEIRA CARLOS &	DE OLIVEIRA RITA DE CASSIA	75 WALNUT ST - UNIT 216	PEABODY, MA 01960
086-632	SOARES BRENT &	VIERA-CONTRERAS KATIUSKA	75 WALNUT ST UNIT 301	PEABODY, MA 01960
086-633	SANTANA SOLENNE B		75 WALNUT ST - UNIT 302	PEABODY, MA 01960
086-634	SANTIANO-MCHATTON KATHERINE		75 WALNUT ST - UNIT 303	PEABODY, MA 01960
086-635	UPTON MANOR APARTMENT LLC		5 LISA RD	PEABODY, MA 01960
086-636	BODINAKU ARTAN & VARVARA		75 WALNUT ST UNIT 305	PEABODY, MA 01960
086-637	ZHUGLI ERILDA & MUSTAFA		75 WALNUT ST - UNIT 306	PEABODY, MA 01960
086-638	BLANARU PATRICIA		75 WALNUT ST UNIT 307	PEABODY, MA 01960
086-639	MCCABE EDWARD T		75 WALNUT ST UNIT 308	PEABODY, MA 01960
086-640	SON HUISOOK JENI & SOK		75 WALNUT ST UNIT 309	PEABODY, MA 01960
086-641	BETTGER JONATHAN R &	BETTGER PATRICIA LAROCQUE	306 LONGHILL AVE	SOMERSET, MA 02726
086-642	FOURNIER BETH A		75 WALNUT ST - UNIT 311	PEABODY, MA 01960
086-643	RITTMULLER ROBERT J		75 WALNUT ST - UNIT 312	PEABODY, MA 01960
086-644	LITCHFIELD DAVID L	BARBOSA FREDERICK & MARIA	75 WALNUT ST UNIT 313	PEABODY, MA 01960
086-645	MEDICO CHRISTOPHER		75 WALNUT ST UNIT 314	PEABODY, MA 01960
086-646	JANIELIS HELEN M		75 WALNUT ST - UNIT 315	PEABODY, MA 01960
086-647	FOSS DAVID &	FOSS DANIEL	75 WALNUT ST UNIT 316	PEABODY, MA 01960
126-001	B & M RAILROAD (MBTA)	GUILFORD TRANSPORTATION IND INC	IRON HORSE PARK	NO BILLERICA, MA 01862
	SALEM CITY HALL		93 WASHINGTON ST	SALEM, MA 01970

*Teresa R. ...*  
*Joseph ...*  
*Supra/SA ...*



# PEABODY RIVERWALK

## RIVERWALK PARK

WALLIS STREET - CALLER STREET - HOWLEY STREET,  
PEABODY, MA 01960

### SHEET INDEX

L001	COVER SHEET
L100 - L102	SITE INDEX PLAN
L110 - L112	EXISTING CONDITIONS PLAN
L120 - L122	SITE DEMOLITION AND PREPARATION PLAN
L130 - L132	MATERIALS PLAN
L140 - L142	LAYOUT PLAN
L150 - L152	GRADING AND DRAINAGE PLAN
L500 - L504	PLANTING PLAN
L500 - L504	CONSTRUCTION DETAILS
S200-S202	PROPOSED LAYOUT PLAN I - III
S600-S601	WALL SECTIONS AND DETAILS I - II
S602	OVERLOOK FRAMING PLAN, SECTIONS, & DETAILS
S603	TIMBER BRIDGE PLAN & TYP. SECTION
S604	TIMBER BRIDGE DETAILS
S605-S606	BOARDWALK PLAN & ELEVATION
S607	BOARDWALK TYP. SECTIONS
S608	BOARDWALK ABUTMENT TYP. SECTIONS
C601	EROSION AND SEDIMENT CONTROL DETAILS
E001	ELECTRICAL LEGEND, NOTES AND ABBREVIATIONS
E101 - E103	ELECTRICAL SITE PLAN A - C
E501	ELECTRICAL DETAILS
E601	ELECTRICAL RISER AND SCHEDULES

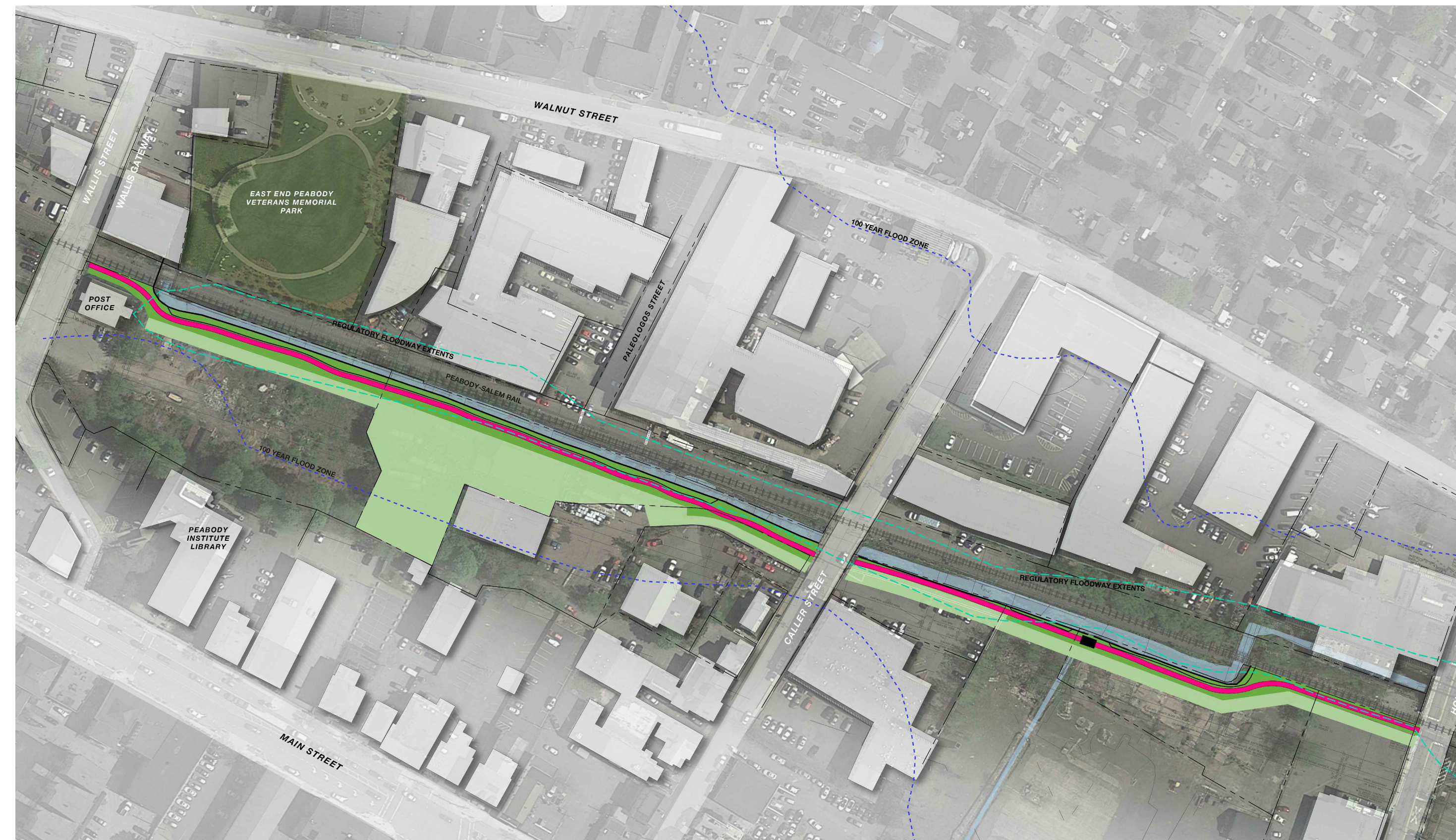

75% CONSTRUCTION DOCUMENTS  
-NOT FOR CONSTRUCTION-

APRIL 2021

### Locus Map

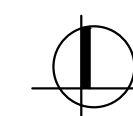

PEABODY RIVERWALK VICINITY MAP  
PEABODY, MA 01960







Prepared By

**Weston & Sampson**<sup>SM</sup>  
design studio

Weston & Sampson Engineers, inc.  
85 Devonshire St., 3rd Floor,  
Boston, MA 02109  
(617) 412-4480  
www.westonandsampson.com



**LEGEND**

-  PROPERTY LINE
-  LIMIT OF WORK
-  EASEMENTS
-  100-FT WETLAND BUFFER
-  200-FT RIVERFRONT PROTECTION AREA
-  APPROXIMATE LIMIT OF EXISTING 100-YEAR FLOOD PLAN

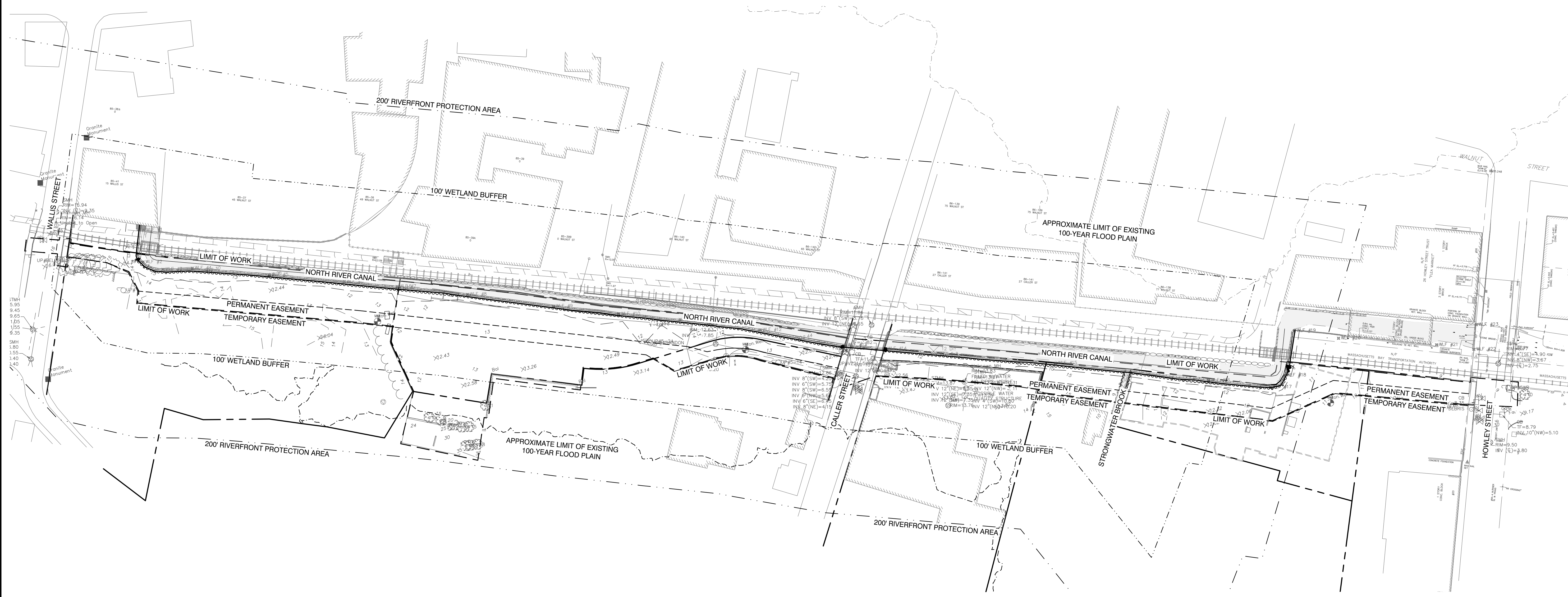

Project:  
**PEABODY RIVERWALK  
 RIVERWALK PARK**



WALLIS STREET -  
 CALLER STREET -  
 HOWLEY STREET  
 PEABODY, MA. 01960

**Weston & Sampson**  
 WESTON & SAMPSON ENGINEERS, INC.  
 85 DEVONSHIRE STREET, 3RD FLOOR  
 BOSTON, MA 02109  
 617-412-4480  
 www.westonandsampson.com

Consultants:

Revisions:

No.	Date	Description

Seal:

Key Plan:



Issued For:  
**75% CONSTRUCTION  
 DOCUMENTS  
 - NOT FOR CONSTRUCTION -**

Scale: 1" = 60'  
 Date: APRIL 2021  
 Drawn By: FD, TY, SG  
 Reviewed By: CC  
 Approved By: CFR

W&S Project No.: ENG20-0145  
 W&S File No.:

Drawing Title:  
**SITE INDEX PLAN**

Sheet Number:  
**L001**

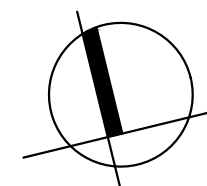
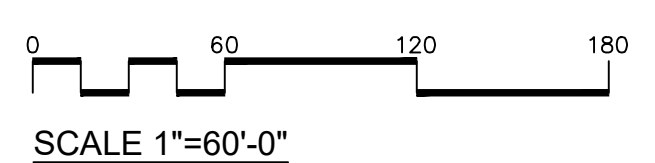

PEABODY RIVERWALK PARK - 20210401 - 10:00 AM - 10:00 AM



**LEGEND**

	PROPERTY LINE		DECIDUOUS TREE		MONUMENT
	LIMIT OF WORK		CONIFEROUS TREE		IRON PIN / IRON ROD
	EASEMENTS		SHRUB/BUSH		HANDICAP SPACE
	100' WETLAND BUFFER		SIGN		SANITARY MANHOLE (SMH)
	200' RIVERFRONT PROTECTION AREA		UTILITY POLE		STORM MANHOLE (STMH)
	APPROXIMATE LIMIT OF EXISTING 100-YEAR FLOOD PLAIN		LIGHT POLE		CATCHBASIN (CB)
	MAJOR CONTOUR LINE		HYDRANT		METAL POST/BOLLARD (BOL)
	MINOR CONTOUR LINE		WATER SHUTOFF		ELECTRIC MANHOLE (MHE)
			GAS VALVE		UNKNOWN MANHOLE
			WATER VALVE		TELEPHONE MANHOLE (MHT)

**GENERAL NOTES**

- BEARINGS REFER TO THE MASSACHUSETTS NAD 83 STATE PLANE COORDINATE SYSTEM (MAINLAND ZONE).
- ELEVATIONS REFER TO THE NORTH AMERICAN VERTICAL DATUM OF 1988.
- REFERENCE IS MADE TO THE FOLLOWING MAPS:
  - "LAND OF ANNABLE BROS. PEABODY", BY GUY W. RICKER, SCALE 1"=20', DATED SEPT. 1902, RECORDED IN BOOK 1683, PLAN 438 OF THE ESSEX SOUTH REGISTRY OF DEEDS.
  - "LAND OF MORRILL LEATHER CO. PEABODY MASS.", BY GUY W. RICKER, SCALE 1"=20', DATED DEC. 1902, RECORDED AS MAP 1669 - 600.
  - "STATION MAP - LANDS BOSTON AND MAINE R.R. STATION 45+0 TO STATION 95+0", SCALE 1"=100', DATED JUNE 30, 1914, REVISED TO DEC. 1, 1975, RECORDED IN PLAN BOOK 141, PLAN 20 OF THE ESSEX SOUTH REGISTRY OF DEEDS.
  - "PLAN OF LAND IN PEABODY", BY THOMAS A. APPLETON, SCALE 1"=20', DATED OCT. 27, 1914, LAND COURT PLAN 5137A.
  - "PLAN OF LAND IN PEABODY", BY THOMAS A. APPLETON, SCALE 1"=20', DATED AUGUST 1916, RECORDED IN PLAN BOOK 30, PLAN 39 OF THE ESSEX SOUTH REGISTRY OF DEEDS.
  - PLAN OF LAND IN PEABODY", BY THOMAS A. APPLETON, SCALE 1"=20', DATED OCT. 1918, LAND COURT PLAN 6997A.
  - "PLAN OF LAND - PEABODY, MASS. BELONGING TO THE MORRILL LEATHER CO.", BY SHAY & SHAY, SCALE 1"=20', DATED FEB. 14, 1930, RECORDED AS PLAN 110 OF 1930 OF THE ESSEX SOUTH REGISTRY OF DEEDS.
  - "SUBDIVISION PLAN OF LAND IN PEABODY", BY OSBORN PALMER, SCALE 1"=40', DATED SEPTEMBER 1952, LAND COURT PLAN 6997C.
  - "PLAN OF LAND IN PEABODY PROPERTY OF HOWLEY REALTY TRUST OF PEABODY", BY OSBORN PALMER, INC., SCALE 1"=20', DATED FEB. 26, 1965, RECORDED IN PLAN BOOK 104, PLAN 12 OF THE ESSEX SOUTH REGISTRY OF DEEDS.
  - "SUBDIVISION PLAN OF LAND IN PEABODY", BY OSBORN PALMER INC, SCALE 1"=50', DATED MAY 26, 1966, LAND COURT PLAN 5137B.
  - "SUBDIVISION PLAN OF LAND IN PEABODY", BY OSBORN PALMER INC, SCALE 1"=50', DATED FEBRUARY 5, 1967, LAND COURT PLAN 5137C.

- "EASEMENT PLAN PEABODY-SALEM INTERCEPTING SEWER FROM SALEM-PEABODY LINE TO PEABODY SQUARE PEABODY, MASS." BY RAYMOND C. PRESSEY, INC. SCALE 1"=20', DATED APRIL 15, 1971, REVISED JUNE 15, 1971, RECORDED IN PLAN BOOK 121 PLAN 64 OF THE ESSEX SOUTH REGISTRY OF DEEDS.
- "PLAN OF LAND IN PEABODY PREPARED FOR E.H. PORTER CONSTRUCTION COMPANY", BY ESSEX SURVEY SERVICE, INC., SCALE 1"=20', DATED NOV. 28, 1975, RECORDED IN PLAN BOOK 136, PLAN 37 OF THE ESSEX SOUTH REGISTRY OF DEEDS.
- "PLAN OF LAND IN PEABODY PREPARED FOR BOB-KAT TANNING CO., INC.", BY ESSEX SURVEY SERVICE INC., SCALE 1"=20', DATED APRIL 27, 1976, RECORDED IN PLAN BOOK 144, PLAN 52 OF THE ESSEX SOUTH REGISTRY OF DEEDS.
- "COUNTY OF ESSEX, MASSACHUSETTS PLAN OF A PORTION OF WALLIS STREET FROM MAIN STREET TO WALNUT STREET IN THE CITY OF PEABODY AS RELOCATED", SCALE 1"=20', DATED MARCH 5, 1985, REVISED DEC. 4, 1990, COUNTY RECORD NUMBER 3204.
- "SUBDIVISION PLAN OF LAND LOCATED IN PEABODY, MASS.", BY EASTERN LAND SURVEY ASSOCIATES, INC., SCALE 1"=40', DATED JULY 14, 1986, REVISED NOVEMBER 7, 1989, RECORDED IN PLAN BOOK 260, PLAN 46 OF THE ESSEX SOUTH REGISTRY OF DEEDS.
- "SUBDIVISION PLAN OF LAND LOCATED IN PEABODY, MASS. PREPARED FOR EASTERN LAND SURVEY ASSOCIATES, INC., SCALE 1"=40', DATED APRIL 2, 2001, RECORDED IN PLAN BOOK 350, PLAN 53 OF THE ESSEX SOUTH REGISTRY OF DEEDS.
- "EASEMENT PLAN OF LAND LOCATED IN PEABODY, MASS." BY EASTERN LAND SURVEY ASSOCIATES, INC., SCALE 1"=20', DATED OCTOBER 18, 2004, RECORDED IN PLAN BOOK 386, PLAN 11 OF THE ESSEX SOUTH REGISTRY OF DEEDS.
- "SUBDIVISION PLAN OF LAND LOCATED IN PEABODY, MASSACHUSETTS", BY EASTERN LAND SURVEY ASSOCIATES, INC., SCALE 1"=40', DATED AUGUST 22, 2008, RECORDED IN PLAN BOOK 416, PLAN 7 OF THE ESSEX SOUTH REGISTRY OF DEEDS.
- "PLAN OF LAND LOCATED IN PEABODY, MASS.", BY EASTERN LAND SURVEY ASSOCIATES, INC., SCALE 1"=40', DATED MAY 17, 2010, RECORDED IN PLAN BOOK 424, PLAN 17 OF THE ESSEX SOUTH REGISTRY OF DEEDS.
- "PLAN OF LAND LOCATED IN PEABODY, MASSACHUSETTS (ESSEX COUNTY) PREPARED FOR MASSACHUSETTS BAY TRANSPORTATION AUTHORITY - CITY OF PEABODY", BY MERIDIAN ASSOCIATES, SCALE 1"=30', DATED MARCH 30, 2012, RECORDED IN PLAN BOOK 433, PLAN 91 OF THE ESSEX SOUTH REGISTRY OF DEEDS.

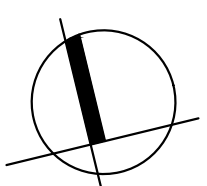
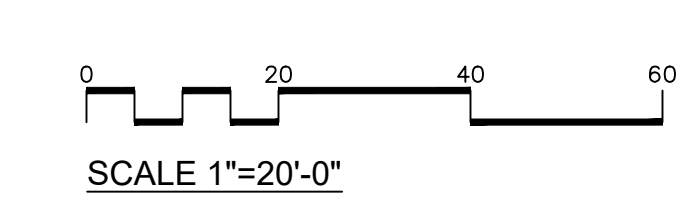
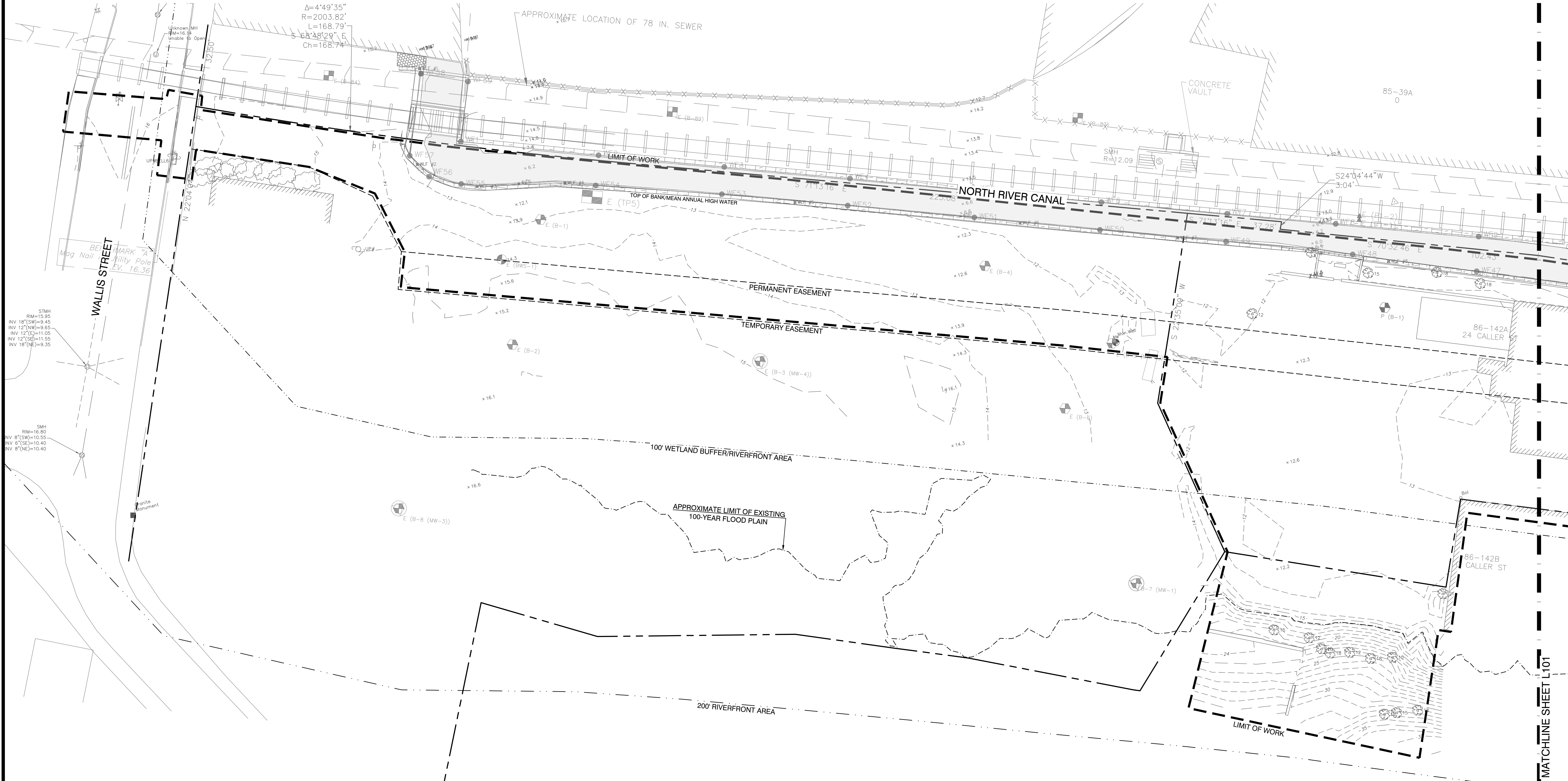

Project:  
**PEABODY RIVERWALK  
 RIVERWALK PARK**

WALLIS STREET -  
 CALLER STREET -  
 HOWLEY STREET  
 PEABODY, MA. 01960

**Weston & Sampson**  
 WESTON & SAMPSON ENGINEERS, INC.  
 85 DEVONSHIRE STREET, 3RD FLOOR  
 BOSTON, MA 02109  
 617-412-4480  
 www.westonandsampson.com

Consultants:

No.	Date	Description

Revisions:

No.	Date	Description

Seal:

Key Plan:

Issued For:  
**75% CONSTRUCTION  
 DOCUMENTS  
 - NOT FOR CONSTRUCTION -**

Scale: 1" = 20'  
 Date: APRIL 2021  
 Drawn By: FD, TY, SG  
 Reviewed By: CC  
 Approved By: CFR

W&S Project No.: ENG20-0145  
 W&S File No.:

Drawing Title:  
**EXISTING  
 CONDITIONS PLAN**

Sheet Number:  
**L100**



**LEGEND**

	PROPERTY LINE		DECIDUOUS TREE		MONUMENT
	LIMIT OF WORK		CONIFEROUS TREE		IRON PIN / IRON ROD
	EASEMENTS		SHRUB/BUSH		HANDICAP SPACE
	100' WETLAND BUFFER		SIGN		SANITARY MANHOLE (SMH)
	200' RIVERFRONT PROTECTION AREA		UTILITY POLE		STORM MANHOLE (STMH)
	APPROXIMATE LIMIT OF EXISTING 100-YEAR FLOOD PLAIN		LIGHT POLE		CATCHBASIN (CB)
	MAJOR CONTOUR LINE		HYDRANT		METAL POST/BOLLARD (BOL)
	MINOR CONTOUR LINE		WATER SHUTOFF		ELECTRIC MANHOLE (MHE)
			GAS VALVE		UNKNOWN MANHOLE
			WATER VALVE		TELEPHONE MANHOLE (MHT)

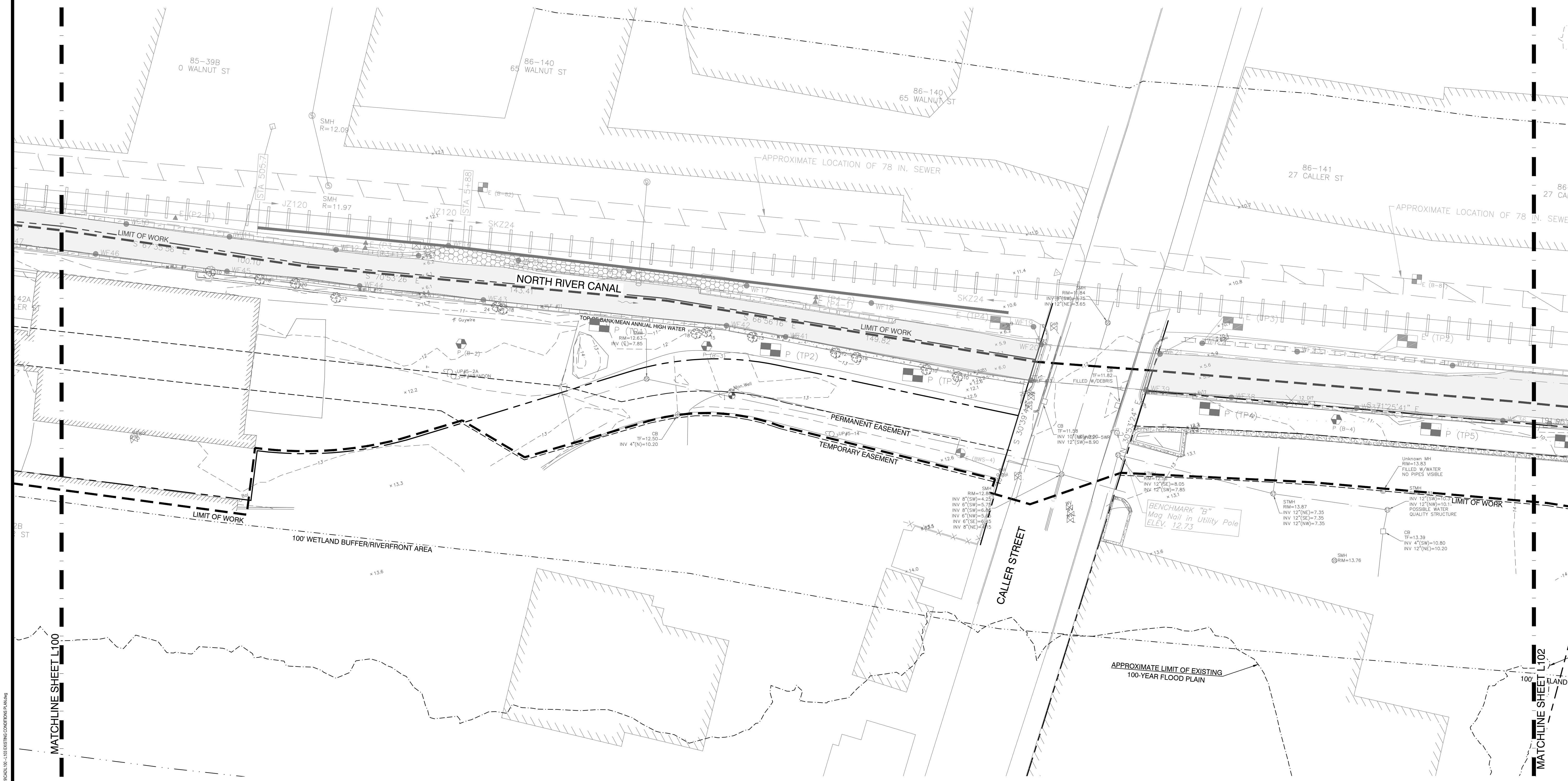

Project:  
**PEABODY RIVERWALK**  
 RIVERWALK PARK

WALLIS STREET -  
 CALLER STREET -  
 HOWLEY STREET  
 PEABODY, MA. 01960

**Weston & Sampson**  
 WESTON & SAMPSON ENGINEERS, INC.  
 85 DEVONSHIRE STREET, 3RD FLOOR  
 BOSTON, MA 02109  
 617-412-4480  
 www.westonandsampson.com

Consultants:

--

Revisions:

No.	Date	Description

Seal:

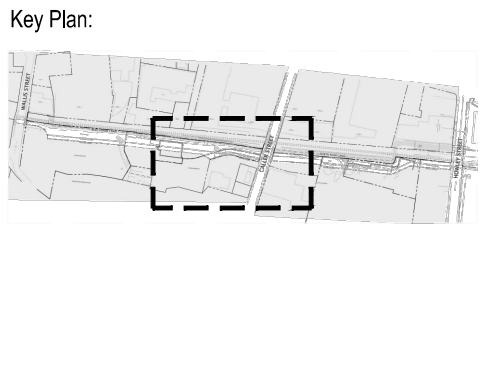

Issued For:  
**75% CONSTRUCTION DOCUMENTS**  
**- NOT FOR CONSTRUCTION -**

Scale: 1" = 20'

Date: APRIL 2021

Drawn By: FD, TY, SG

Reviewed By: CC

Approved By: CFR

W&S Project No.: ENG20-0145

W&S File No.:

Drawing Title:  
**EXISTING CONDITIONS PLAN**

Sheet Number:  
**L101**

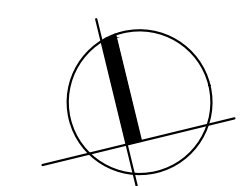
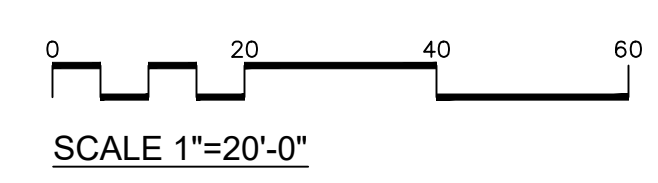

PEABODY RIVERWALK PARK CONSTRUCTION PLAN



**LEGEND**

	PROPERTY LINE		DECIDUOUS TREE		MONUMENT
	LIMIT OF WORK		CONIFEROUS TREE		IRON PIN / IRON ROD
	EASEMENTS		SHRUB/BUSH		HANDICAP SPACE
	100' WETLAND BUFFER		SIGN		SANITARY MANHOLE (SMH)
	200' RIVERFRONT PROTECTION AREA		UTILITY POLE		STORM MANHOLE (STMH)
	APPROXIMATE LIMIT OF EXISTING 100-YEAR FLOOD PLAIN		LIGHT POLE		CATCHBASIN (CB)
	MAJOR CONTOUR LINE		HYDRANT		METAL POST/BOLLARD (BOL)
	MINOR CONTOUR LINE		WATER SHUTOFF		ELECTRIC MANHOLE (MHE)
			GAS VALVE		UNKNOWN MANHOLE
			WATER VALVE		TELEPHONE MANHOLE (MHT)

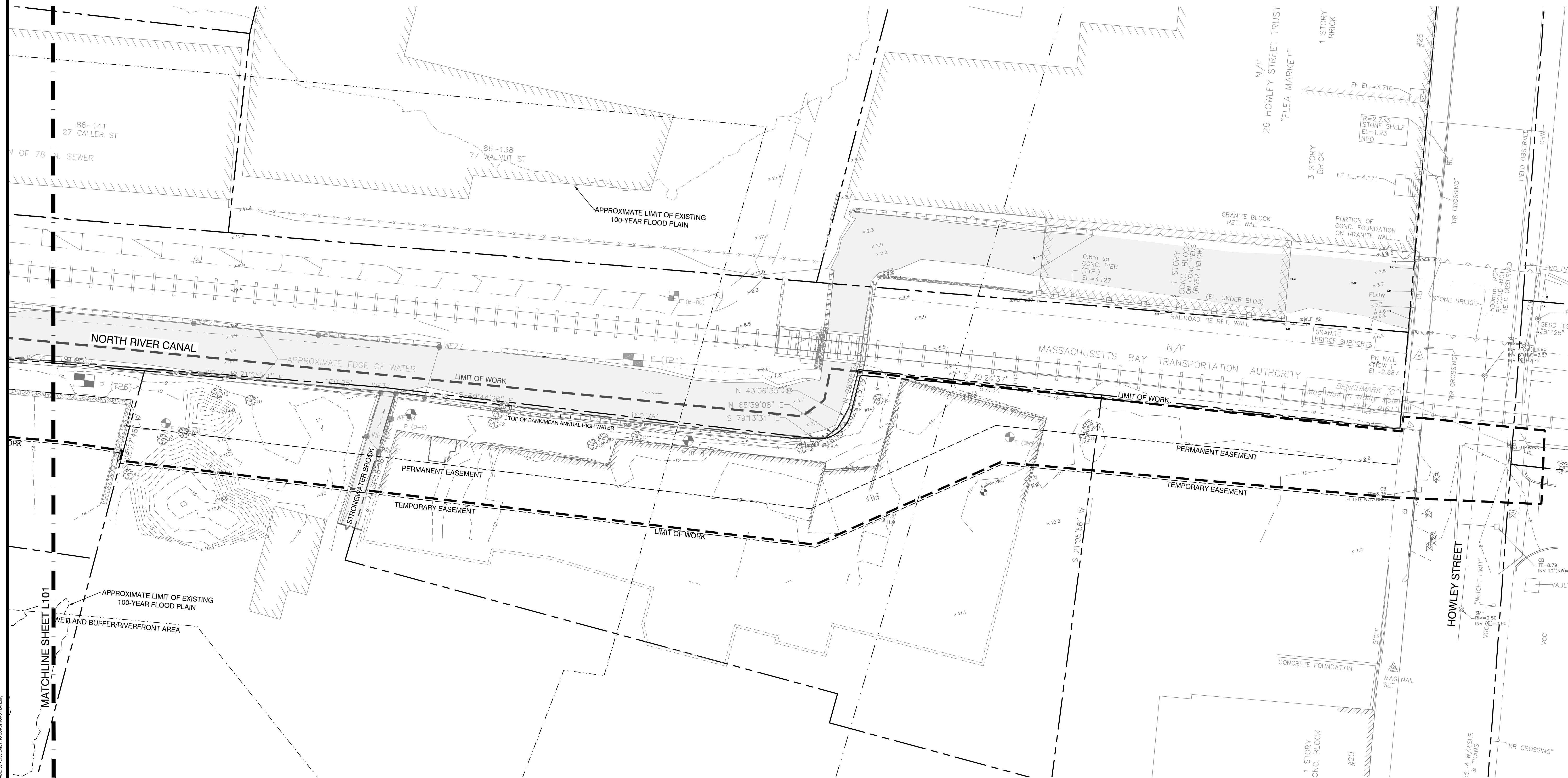

Project:  
**PEABODY RIVERWALK RIVERWALK PARK**  
  
 WALLIS STREET - CALLER STREET - HOWLEY STREET  
 PEABODY, MA. 01960

**Weston & Sampson**  
 WESTON & SAMPSON ENGINEERS, INC.  
 85 DEVONSHIRE STREET, 3RD FLOOR  
 BOSTON, MA 02109  
 617-412-4480  
 www.westonandsampson.com

Consultants:

--

Revisions:

No.	Date	Description

Seal:

Key Plan:

Issued For:

**75% CONSTRUCTION DOCUMENTS**  
**- NOT FOR CONSTRUCTION -**

Scale: 1" = 20'

Date: APRIL 2021

Drawn By: FD, TY, SG

Reviewed By: CC

Approved By: CFR

W&S Project No.: ENG20-0145  
 W&S File No.:

Drawing Title:

**EXISTING CONDITIONS PLAN**

Sheet Number:

**L102**

COPYRIGHT © 2020 WESTON & SAMPSON, INC.



**LEGEND**

	PROPERTY LINE	TYP.	TYPICAL
	LIMIT OF WORK	EX.	EXISTING
	EASEMENTS	R&D	REMOVE AND DISPOSE
	100' WETLAND BUFFER	R&R	REMOVE AND RESET
	100' RIVERFRONT PROTECTION AREA	R&S	REMOVE AND STORE
	APPROXIMATE LIMIT OF EXISTING 100-YEAR FLOOD PLAIN		
	COMPOST SOCKS		

**DEMOLITION & SITE PREPARATION NOTES**

1. THE CONTRACTOR SHALL INCLUDE IN THE BID THE COST OF REMOVING ANY EXISTING SITE FEATURES NECESSARY TO ACCOMPLISH THE CONSTRUCTION OF THE PROPOSED SITE IMPROVEMENTS. THE CONTRACTOR SHALL ALSO INCLUDE IN THE BID THE COST NECESSARY TO RESTORE SUCH ITEMS IF THEY ARE DISTURBED YET SCHEDULED TO REMAIN AS PART OF THE FINAL SITE IMPROVEMENTS. REFER TO PLANS TO DETERMINE EXCAVATION AND DEMOLITION REQUIRED TO RECEIVE PROPOSED SITE IMPROVEMENTS AND TO DETERMINE THE LOCATION OF PROPOSED SITE IMPROVEMENTS.
2. THE OWNER RESERVES THE RIGHT TO REVIEW ALL MATERIALS DESIGNATED FOR REMOVAL AND TO RETAIN OWNERSHIP OF SUCH MATERIALS. IF THE OWNER RETAINS ANY MATERIAL THE CONTRACTOR SHALL MAKE ARRANGEMENTS WITH THE OWNER TO HAVE THOSE MATERIALS DELIVERED TO FRANKLIN PARK YARD AT NO ADDITIONAL EXPENSE TO THE OWNER.
3. UNLESS SPECIFICALLY NOTED TO BE SAVED OR REUSED, ALL SITE FEATURES CALLED FOR REMOVAL SHALL BE TRANSPORTED FROM THE SITE AND DISPOSED OF IN A LAWFUL MANNER AT AN ACCEPTABLE DISPOSAL SITE AT NO COST TO THE OWNER.
4. ALL EXISTING SITE FEATURES TO REMAIN SHALL BE PROTECTED THROUGHOUT THE CONSTRUCTION PERIOD. ANY FEATURES DAMAGED DURING CONSTRUCTION OPERATIONS SHALL BE REPAIRED OR REPLACED TO THE SATISFACTION OF THE OWNER AND OWNER'S REPRESENTATIVE AT NO ADDITIONAL COST TO THE OWNER.
5. DURING EARTHWORK OPERATIONS, CONTRACTOR SHALL TAKE CARE TO NOT DISTURB EXISTING MATERIALS TO REMAIN, OUTSIDE THE LIMITS OF EXCAVATION AND BACKFILL AND SHALL TAKE WHATEVER MEASURES NECESSARY, AT THE CONTRACTOR'S EXPENSE, TO PREVENT ANY EXCAVATED MATERIAL FROM COLLAPSING. ALL BACKFILL MATERIALS SHALL BE PLACED AND COMPACTED AS SPECIFIED TO THE SUBGRADE REQUIRED FOR THE INSTALLATION OF THE REMAINDER OF THE CONTRACT WORK.
6. ALL ITEMS CALLED FOR REMOVAL (COMPLETE) SHALL BE REMOVED TO FULL DEPTH INCLUDING ALL FOOTINGS, FOUNDATIONS, AND OTHER APPURTENANCES, EXCEPT AS SPECIFICALLY NOTED OTHERWISE.
7. CONTRACTOR SHALL INSTALL TREE PROTECTION BARRIER AT DRIPLINE AFTER CLEARING UNDERBRUSH AND TAKE DUE CARE TO PREVENT INJURY TO TREES DURING CLEARING OPERATIONS. TREES TO REMAIN SHALL BE PRUNED.
8. THE STORAGE OF MATERIALS AND EQUIPMENT WILL BE PERMITTED AT LOCATIONS DESIGNATED BY OWNER OR OWNER'S REPRESENTATIVE. PROTECTION OF STORED MATERIALS AND EQUIPMENT SHALL BE THE SOLE RESPONSIBILITY OF THE CONTRACTOR. THERE SHALL BE NO STORAGE OF MATERIALS OR PARKING OF CONSTRUCTION VEHICLES WITHIN DRIPLINE OF TREES.
9. **DEMOLITION AND SITE REMEDIATION OF 24 CALLER STREET SHALL BE COMPLETED BY OTHERS PRIOR TO THE COMMENCEMENT OF CONSTRUCTION**

10. ALL SEDIMENT AND EROSION CONTROL DEVICES SHALL BE PUT INTO PLACE PRIOR TO BEGINNING ANY CONSTRUCTION OR DEMOLITION.
11. THE CONTRACTOR SHALL BE RESPONSIBLE FOR THE CONTINUAL MAINTENANCE OF ALL EROSION CONTROL DEVICES THROUGHOUT THE DURATION OF THE PROJECT.
12. CONTRACTOR SHALL MEET ALL THE COMMONWEALTH OF MASSACHUSETTS D.E.P. AND THE CITY OF PEABODY'S WETLAND ORDINANCE REGULATIONS FOR SEDIMENT AND EROSION CONTROL.
13. THE CONTRACTOR SHALL PROVIDE DUST CONTROL FOR CONSTRUCTION OPERATIONS AS APPROVED BY OWNER.
14. ALL POINTS OF CONSTRUCTION EGRESS OR INGRESS SHALL BE MAINTAINED TO PREVENT TRACKING OR FLOWING OF SEDIMENT ONTO PUBLIC / PRIVATE ROADS.

**NOTES:**

1. CONTRACTOR SHALL PROVIDE 6'-HT CONSTRUCTION FENCE PLACED AT LIMIT OF WORK OR USE EXISTING FENCE IN PLACE. CONTRACTOR IS RESPONSIBLE FOR SECURING THE SITE AT ALL TIMES FOR THE DURATION OF THE CONSTRUCTION PERIOD.
2. CONTRACTOR MUST NOTIFY OWNER AND CITY OF PEABODY DEPARTMENT OF PUBLIC WORKS OF ANY WORK TO BE COMPLETED WITHIN THE RIGHT OF WAY FORTY-EIGHT (48) PRIOR TO COMMENCING WORK.
3. CONTRACTOR SHALL PROTECT ALL UTILITY POLES THAT FALL WITHIN THE LIMIT OF WORK.
4. CONTRACTOR SHALL CLEAR AND WATER JET ALL DRAINAGE STRUCTURES AND LINES WITHIN THE LIMIT OF WORK AND VERIFY WORKING CONDITION.

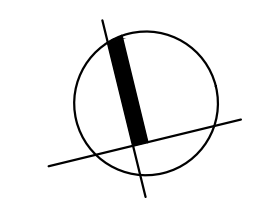
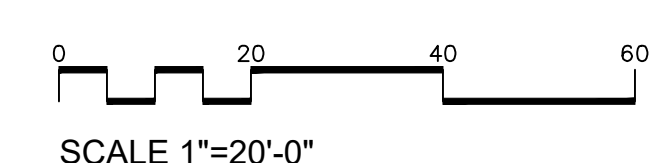
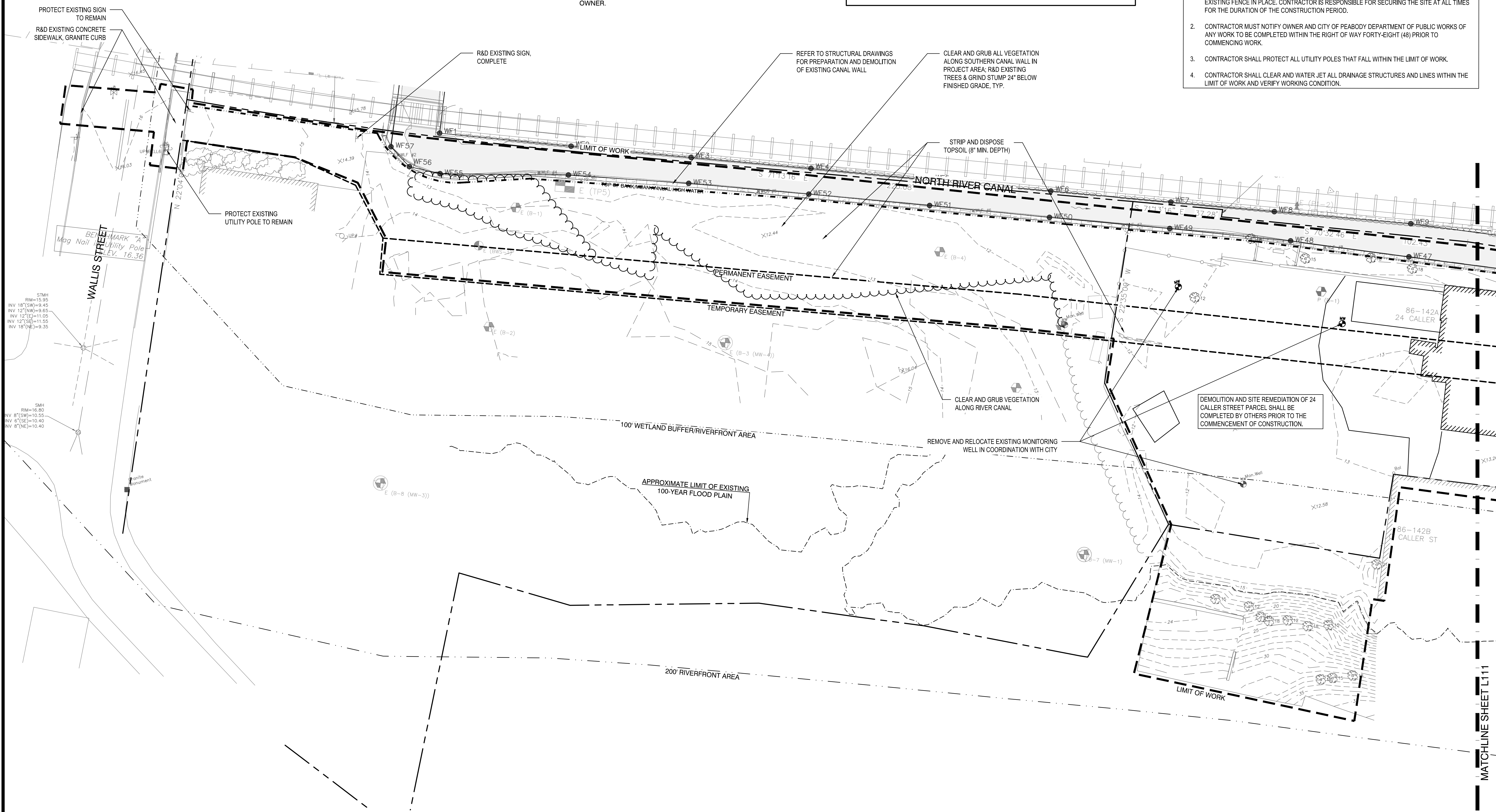

Project:  
**PEABODY RIVERWALK RIVERWALK PARK**  
  
 WALLIS STREET - CALLER STREET - HOWLEY STREET  
 PEABODY, MA. 01960

**Weston & Sampson**  
 WESTON & SAMPSON ENGINEERS, INC.  
 85 DEVONSHIRE STREET, 3RD FLOOR  
 BOSTON, MA 02109  
 617-412-4480  
 www.westonandsampson.com

Consultants:

--	--

Revisions:

No.	Date	Description

Seal:

Key Plan:



Issued For:  
**75% CONSTRUCTION DOCUMENTS - NOT FOR CONSTRUCTION -**

Scale: 1" = 20'

Date: APRIL 2021  
 Drawn By: FD, TY, SG  
 Reviewed By: CC  
 Approved By: CFR

W&S Project No.: ENG20-0145  
 W&S File No.:

Drawing Title:  
**SITE DEMOLITION AND PREPARATION PLAN**

Sheet Number:  
**L110**



**LEGEND**

	PROPERTY LINE	TYP.	TYPICAL
	LIMIT OF WORK	EX.	EXISTING
	EASEMENTS	R&D	REMOVE AND DISPOSE
	100' WETLAND BUFFER	R&R	REMOVE AND RESET
	100' RIVERFRONT PROTECTION AREA	R&S	REMOVE AND STORE
	APPROXIMATE LIMIT OF EXISTING 100-YEAR FLOOD PLAIN		
	COMPOST SOCKS		

Project:  
**PEABODY RIVERWALK RIVERWALK PARK**  
  
 WALLIS STREET - CALLER STREET - HOWLEY STREET  
 PEABODY, MA. 01960

**Weston & Sampson**  
 WESTON & SAMPSON ENGINEERS, INC.  
 85 DEVONSHIRE STREET, 3RD FLOOR  
 BOSTON, MA 02109  
 617-412-4480  
 www.westonandsampson.com

Consultants:

Revisions:

No.	Date	Description

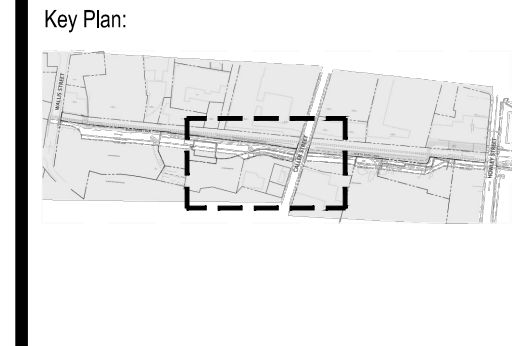

Issued For:  
**75% CONSTRUCTION DOCUMENTS**  
**- NOT FOR CONSTRUCTION -**

Scale: 1" = 20'  
 Date: APRIL 2021  
 Drawn By: FD, TY, SG  
 Reviewed By: CC  
 Approved By: CFR

W&S Project No.: ENG20-0145  
 W&S File No.:

Drawing Title:  
**SITE DEMOLITION AND PREPARATION PLAN**

Sheet Number:  
**L111**

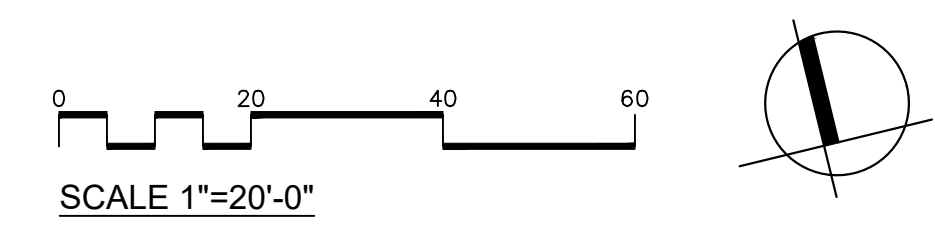
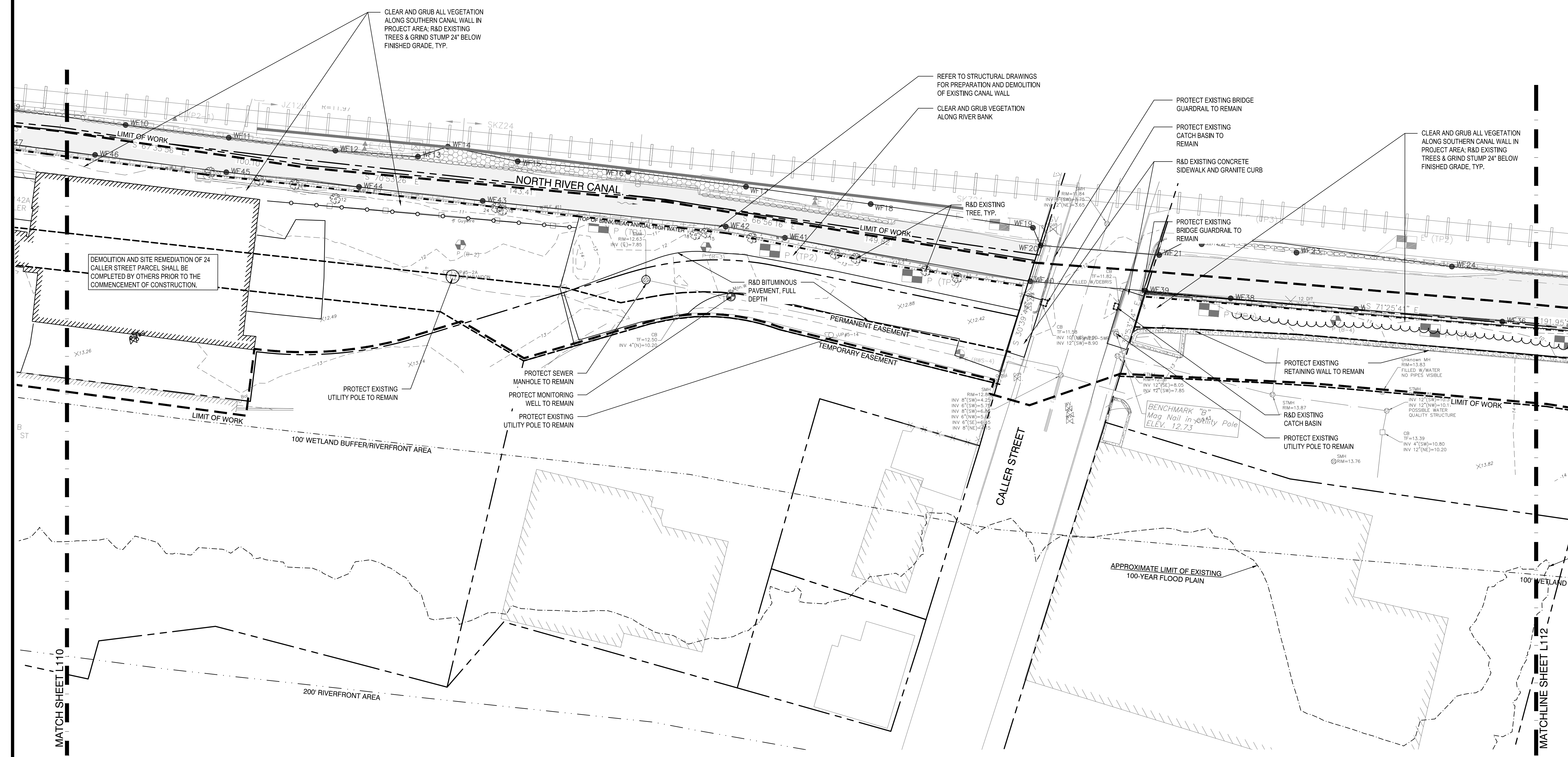

PEABODY RIVERWALK PARK - WESTON & SAMPSON ENGINEERS, INC. - 11/20/2021 10:45 AM



**LEGEND**

	PROPERTY LINE	TYP.	TYPICAL
	LIMIT OF WORK	EX.	EXISTING
	EASEMENTS	R&D	REMOVE AND DISPOSE
	100' WETLAND BUFFER	R&R	REMOVE AND RESET
	100' RIVERFRONT PROTECTION AREA	R&S	REMOVE AND STORE
	APPROXIMATE LIMIT OF EXISTING 100-YEAR FLOOD PLAIN		
	COMPOST SOCKS		
	INLET SEDIMENT CONTROL		
	CLEAR AND GRUB VEGETATION		

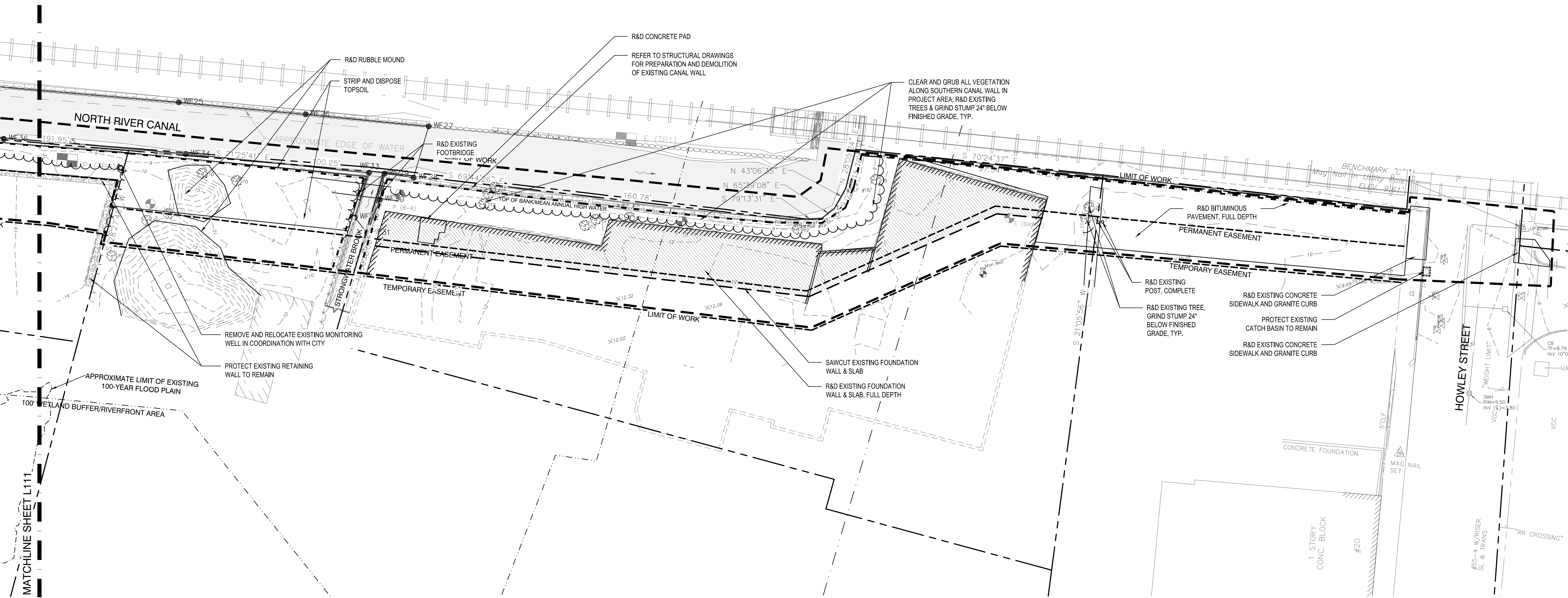

Project:  
**PEABODY RIVERWALK RIVERWALK PARK**  
  
 WALLIS STREET -  
 CALLER STREET -  
 HOWLEY STREET  
 PEABODY, MA. 01960

**Weston & Sampson**  
 WESTON & SAMPSON ENGINEERS, INC.  
 85 DEVONSHIRE STREET, 3RD FLOOR  
 BOSTON, MA 02109  
 617-412-4480  
 www.westonandsampson.com

Consultants:

Revisions:

No.	Date	Description

Seal:

Key Plan:

Issued For:  
**75% CONSTRUCTION DOCUMENTS**  
**- NOT FOR CONSTRUCTION -**

Scale: 1" = 20'

Date: APRIL 2021

Drawn By: FD, TY, SG

Reviewed By: CC

Approved By: CFR

W&S Project No.: ENG20-0145

W&S File No.:

Drawing Title:  
**SITE DEMOLITION AND PREPARATION PLAN**

Sheet Number:  
**L112**

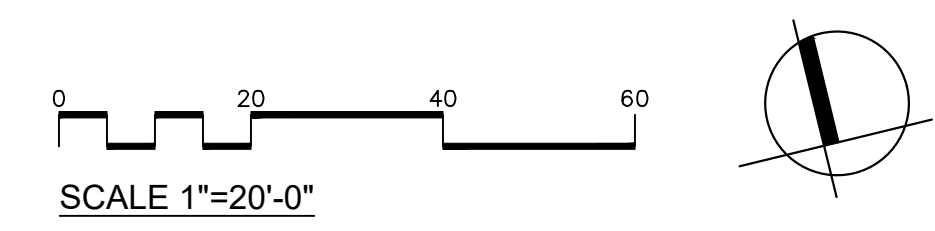

PEABODY RIVERWALK PARK CONSTRUCTION DOCUMENTS, TITLE SHEET PREPARING



**LEGEND**

	PROPERTY LINE		VEHICULAR BITUMINOUS CONCRETE PAVEMENT		STREET LIGHT
	LIMIT OF WORK		BOARDWALK		PEDESTRIAN LIGHT
	EASEMENTS		SLOPE WITH TURF REINFORCEMENT MAT, LOAM, AND NO MOW SEED MIX		RAPID FLASHING BEACON
	100' WETLAND BUFFER		VEGETATED BUFFER PLANTING		EMERGENCY CALL BOX
	200' RIVERFRONT PROTECTION AREA		CIP CONCRETE PAVEMENT		COLLAPSIBLE BOLLARD
	APPROXIMATE LIMIT OF EXISTING 100-YEAR FLOOD PLAIN		EXPANSION JOINT (EJ)		TRASH AND RECYCLE RECEPTACLES ON CONCRETE SLAB
	SHEET PILE WALL		SCORE JOINT (SJ)		DRAIN MANHOLE
	FENCE WITH CABLE RAILING ON BOARDWALK		BENCH WITH BACK		CATCH BASIN
	FENCE WITH CABLE RAILING ON MOW CURB				
	PEDESTRIAN BITUMINOUS CONCRETE PAVEMENT				

**MATERIALS NOTES**

- REFER TO EXISTING CONDITIONS PLAN FOR SURVEY INFORMATION.
- REFER TO PLANTING PLAN FOR PLANT TYPES AND LOCATIONS.
- ALL PROPOSED PAVEMENTS SHALL MEET THE LIEN AND GRADE OF EXISTING ADJACENT PAVEMENT SURFACES AND SHALL BE TREATED WITH RS-1 TACK COAT AND INFRARED LIGHT AT ALL POINTS OF CONNECTION AND ALL SAWCUT EDGES WHERE PROPOSED PAVEMENT MEETS EXISTING PAVEMENT.
- THE DEPTH OF LOAM TOP SOIL FOR ALL RESTORED LAWN AREAS SHALL BE 6" MINIMUM. ALL DISTURBED AREAS SHALL BE RESTORED WITH LOAM AND SEED UNLESS OTHERWISE NOTED.
- ALL LIGHTING CONTROLS TO BE COORDINATED WITH THE CITY OF PEABODY.

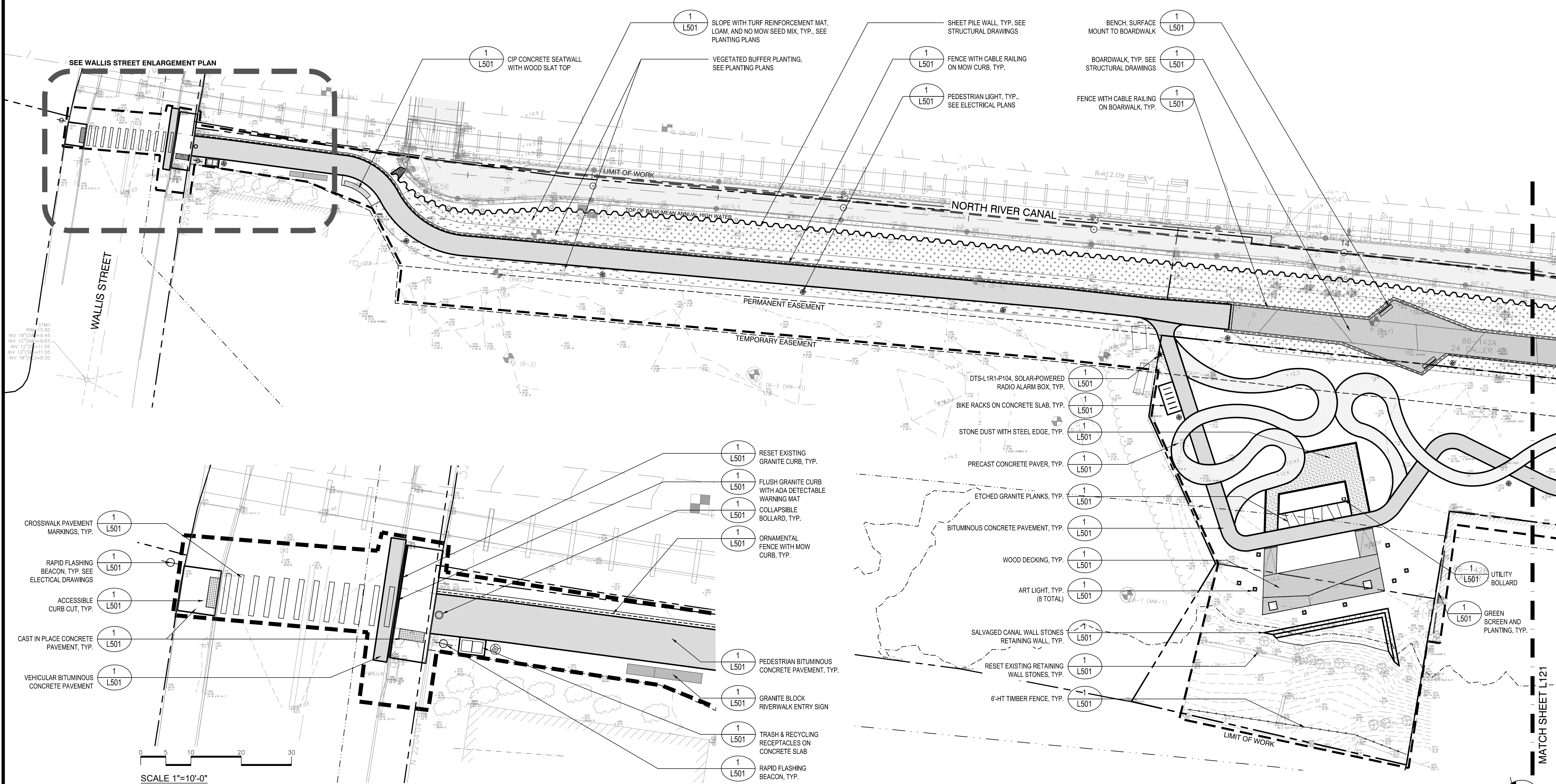

**1** WALLIS STREET ENLARGEMENT PLAN  
SCALE: 1" = 10'-0"

SCALE 1"=20'-0"

MATCH SHEET L121

Project:  
**PEABODY RIVERWALK RIVERWALK PARK**  
  
 WALLIS STREET -  
 CALLER STREET -  
 HOWLEY STREET  
 PEABODY, MA. 01960

**Weston & Sampson**  
 WESTON & SAMPSON ENGINEERS, INC.  
 85 DEVONSHIRE STREET, 3RD FLOOR  
 BOSTON, MA 02109  
 617-412-4480  
 www.westonandsampson.com

Consultants:

--	--	--

Revisions:

No.	Date	Description

Seal:

Key Plan:

Issued For:

**75% CONSTRUCTION DOCUMENTS**  
**- NOT FOR CONSTRUCTION -**

Scale: AS SHOWN

Date: APRIL 2021

Drawn By: FD, TY, SG

Reviewed By: CC

Approved By: CFR

W&S Project No.: ENG20-0145

W&S File No.:

Drawing Title:

**MATERIALS PLAN**

Sheet Number:

**L120**

COPYRIGHT © 2020 WESTON & SAMPSON, INC.



**LEGEND**

- PROPERTY LINE
- - - LIMIT OF WORK
- - - EASEMENTS
- - - 100' WETLAND BUFFER
- - - 200' RIVERFRONT PROTECTION AREA
- - - APPROXIMATE LIMIT OF EXISTING 100-YEAR FLOOD PLAIN
- - - SHEET PILE WALL
- ▨ FENCE WITH CABLE RAILING ON BOARDWALK
- ▨ FENCE WITH CABLE RAILING ON MOW CURB
- ▨ PEDESTRIAN BITUMINOUS CONCRETE PAVEMENT
- ▨ VEHICULAR BITUMINOUS CONCRETE PAVEMENT
- ▨ BOARDWALK
- ▨ SLOPE WITH TURF REINFORCEMENT MAT, LOAM, AND NO MOW SEED MIX
- ▨ VEGETATED BUFFER PLANTING
- ▨ CIP CONCRETE PAVEMENT
- - - EXPANSION JOINT (EJ)
- - - SCORE JOINT (SJ)
- ▬ BENCH WITH BACK
- \* STREET LIGHT
- ⊙ PEDESTRIAN LIGHT
- ⊙ RAPID FLASHING BEACON
- \* EMERGENCY CALL BOX
- COLLAPSIBLE BOLLARD
- TRASH AND RECYCLE RECEPTACLES ON CONCRETE SLAB
- ⊙ DRAIN MANHOLE
- CATCH BASIN

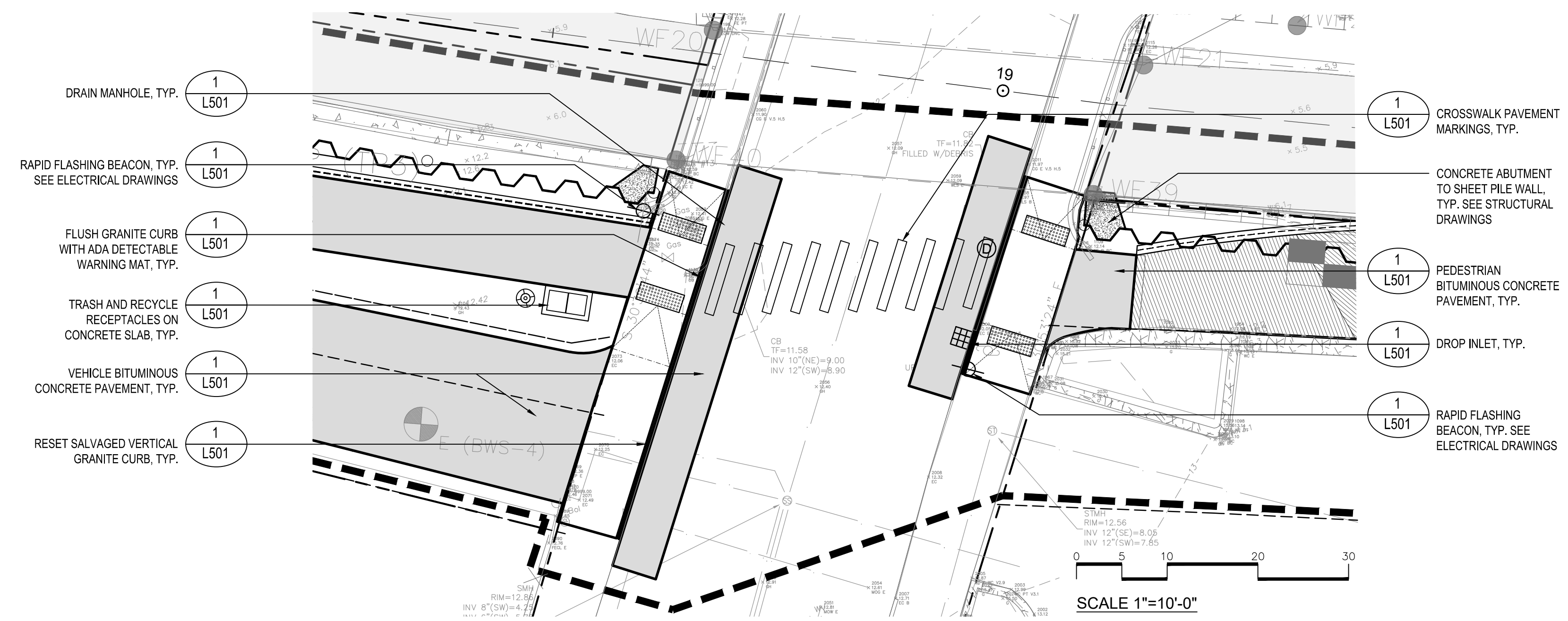

**1 CALLER STREET ENLARGEMENT PLAN**  
SCALE: 1" = 10'-0"

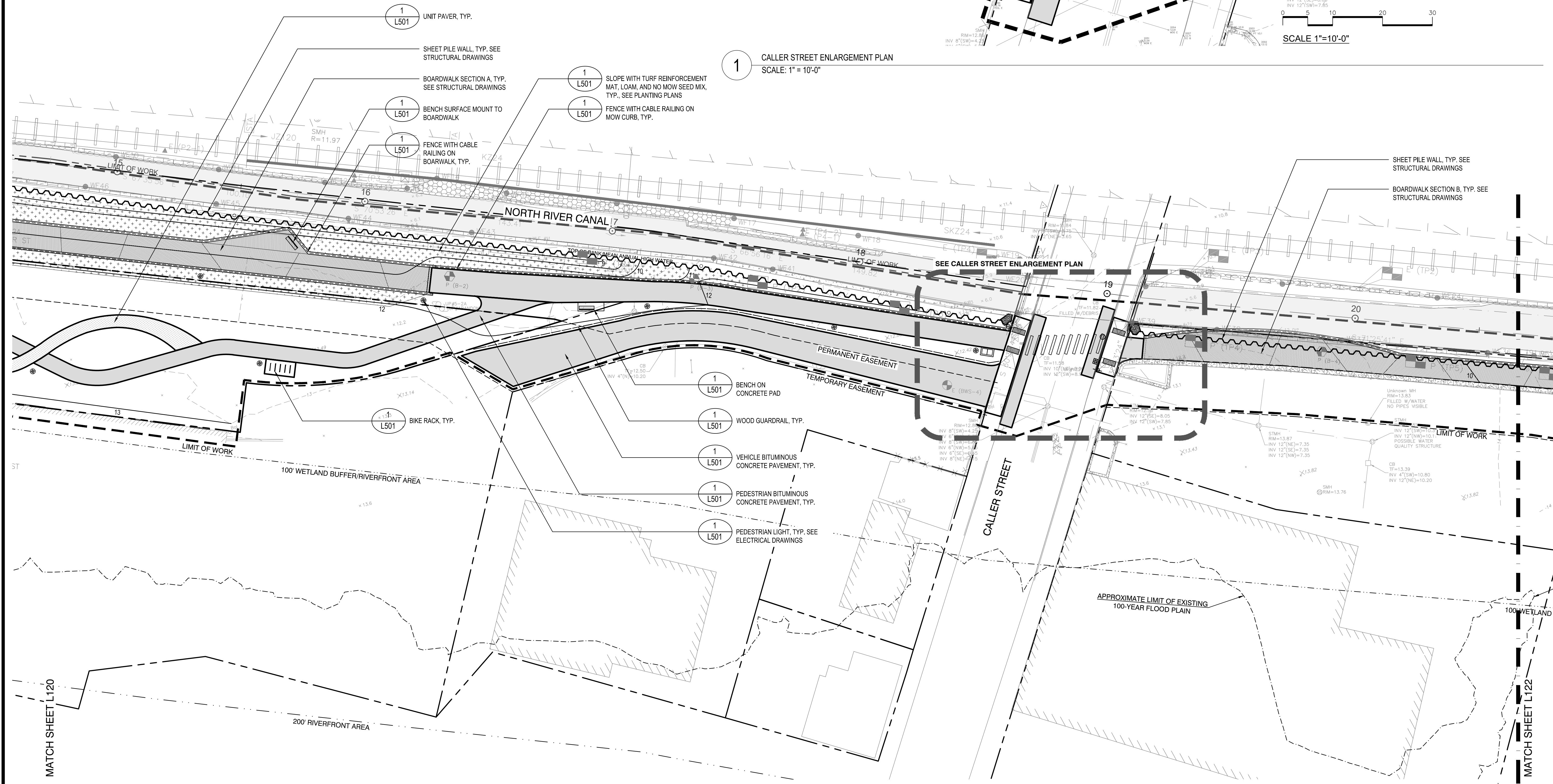

**SCALE 1"=20'-0"**

Project:  
**PEABODY RIVERWALK RIVERWALK PARK**  
  
 WALLIS STREET - CALLER STREET - HOWLEY STREET  
 PEABODY, MA. 01960

**Weston & Sampson**  
 WESTON & SAMPSON ENGINEERS, INC.  
 85 DEVONSHIRE STREET, 3RD FLOOR  
 BOSTON, MA 02109  
 617-412-4480  
 www.westonandsampson.com

Consultants:  
 \_\_\_\_\_  
 \_\_\_\_\_

Revisions:

No.	Date	Description

Seal:  
 \_\_\_\_\_

Key Plan:  

Issued For:  
**75% CONSTRUCTION DOCUMENTS**  
**- NOT FOR CONSTRUCTION -**

Scale: AS SHOWN  
 Date: APRIL 2021  
 Drawn By: FD, TY, SG  
 Reviewed By: CC  
 Approved By: CFR

W&S Project No.: ENG20-0145  
 W&S File No.: \_\_\_\_\_

Drawing Title:  
**MATERIALS PLAN**

Sheet Number:  
**L121**



**LEGEND**

	PROPERTY LINE		VEHICULAR BITUMINOUS CONCRETE PAVEMENT		STREET LIGHT
	LIMIT OF WORK		BOARDWALK		PEDESTRIAN LIGHT
	EASEMENTS		SLOPE WITH TURF REINFORCEMENT MAT, LOAM, AND NO MOW SEED MIX		RAPID FLASHING BEACON
	100' WETLAND BUFFER		VEGETATED BUFFER PLANTING		EMERGENCY CALL BOX
	200' RIVERFRONT PROTECTION AREA		CIP CONCRETE PAVEMENT		COLLAPSIBLE BOLLARD
	APPROXIMATE LIMIT OF EXISTING 100-YEAR FLOOD PLAIN		EXPANSION JOINT (EJ)		TRASH AND RECYCLE RECEPTACLES ON CONCRETE SLAB
	SHEET PILE WALL		SCORE JOINT (SJ)		DRAIN MANHOLE
	FENCE WITH CABLE RAILING ON BOARDWALK		BENCH WITH BACK		CATCH BASIN
	FENCE WITH CABLE RAILING ON MOW CURB				
	PEDESTRIAN BITUMINOUS CONCRETE PAVEMENT				

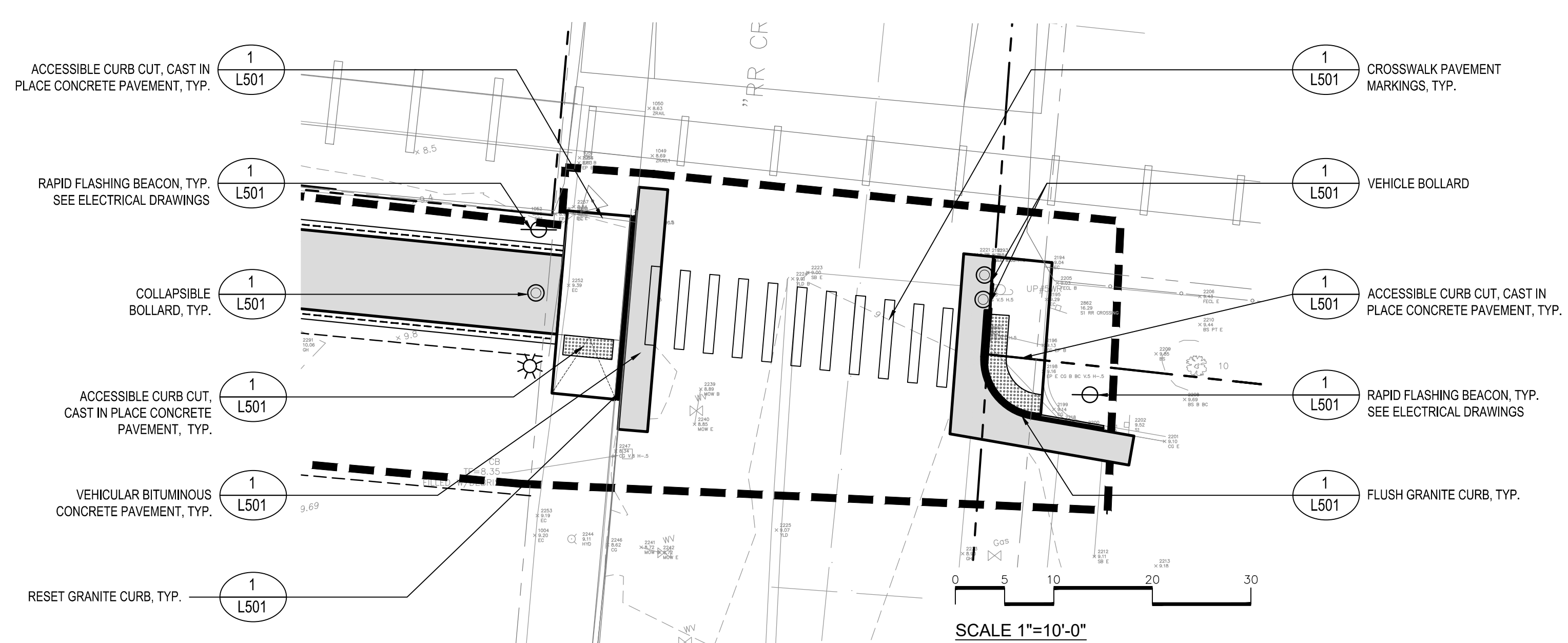

**1** HOWLEY STREET ENLARGEMENT PLAN  
SCALE: 1" = 10'-0"

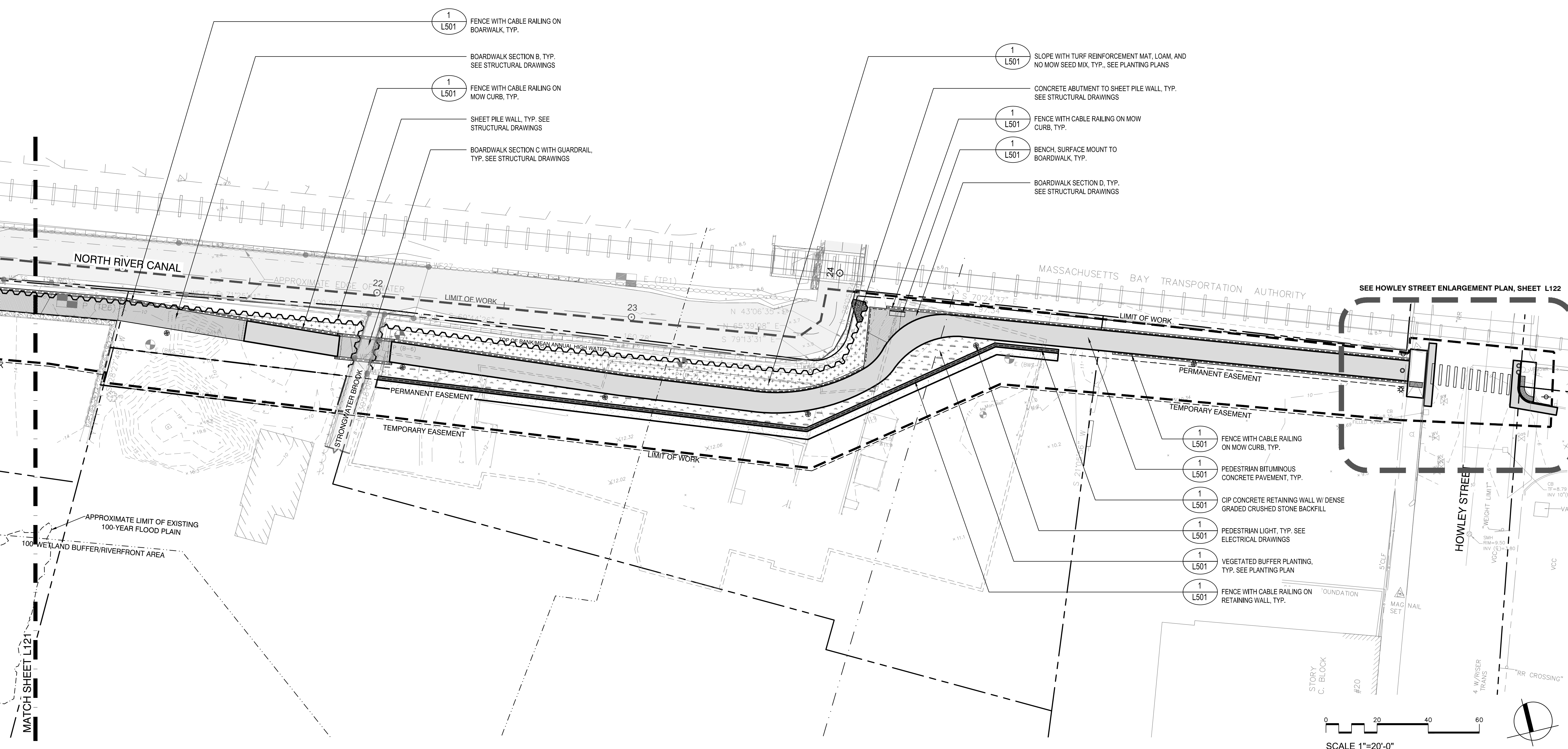

SCALE 1"=20'-0"

Project:  
PEABODY RIVERWALK  
RIVERWALK PARK

WALLIS STREET -  
CALLER STREET -  
HOWLEY STREET  
PEABODY, MA. 01960

**Weston & Sampson**  
WESTON & SAMPSON ENGINEERS, INC.  
85 DEVONSHIRE STREET, 3RD FLOOR  
BOSTON, MA 02109  
617-412-4480  
www.westonandsampson.com

Consultants:

--	--	--

Revisions:

No.	Date	Description

Seal:

Key Plan:

Issued For:

**75% CONSTRUCTION DOCUMENTS**  
**- NOT FOR CONSTRUCTION -**

Scale: AS SHOWN

Date: APRIL 2021

Drawn By: FD, TY, SG

Reviewed By: CC

Approved By: CFR

W&S Project No.: ENG20-0145

W&S File No.:

Drawing Title:

**MATERIALS PLAN**

Sheet Number:

**L122**



**LEGEND**

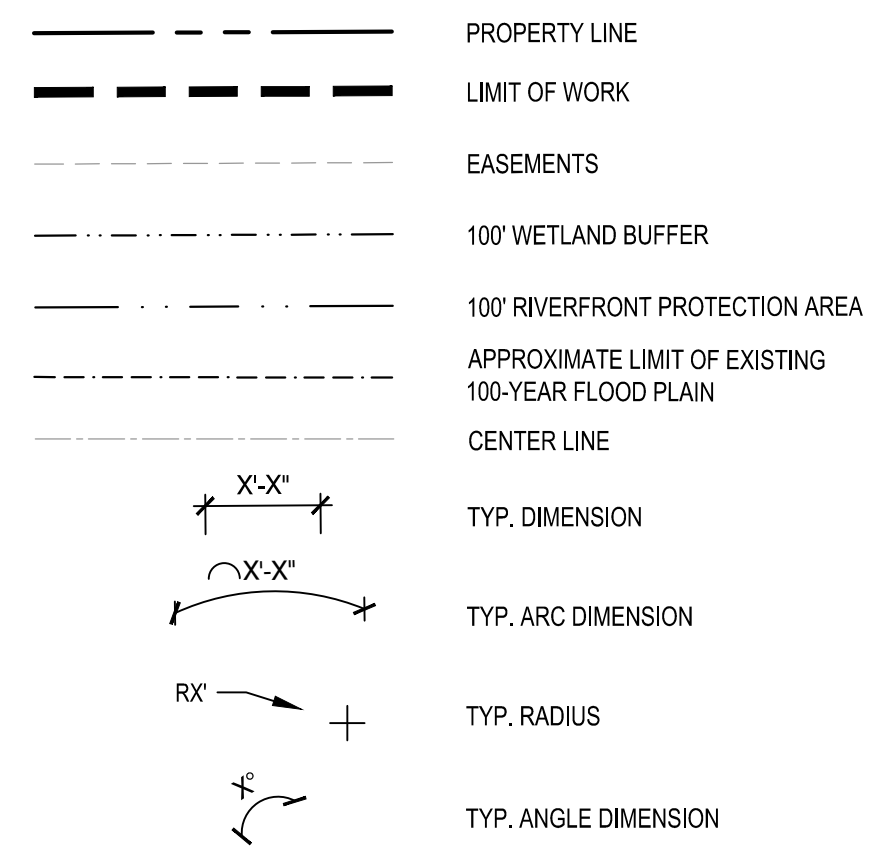

**LAYOUT NOTES**

1. COORDINATE ALL LAYOUT ACTIVITIES WITH THE SCOPE OF WORK CALLED FOR BY DEMOLITION, GRADING, AND UTILITIES OPERATIONS ENCOMPASSED BY THIS CONTRACT. SET, PROTECT, AND REPLACE REFERENCE STAKES AS NECESSARY OR AS DIRECTED BY THE OWNER'S REPRESENTATIVE.
2. ALL LINES AND GRADING WORK AS PER DRAWINGS AND SPECIFICATIONS SHALL BE LAID OUT BY A MASSACHUSETTS REGISTERED CIVIL ENGINEER OR LICENSED SURVEYOR ENGAGED BY THE GENERAL CONTRACTOR.
3. ALL LAYOUT LINES, OFFSETS, OR REFERENCES TO LOCATING OBJECTS ARE EITHER PARALLEL OR PERPENDICULAR UNLESS OTHERWISE DESIGNATED WITH ANGLE OFFSETS NOTED.
4. ALL PROPOSED SITE FEATURES SHALL BE LAID OUT AND STAKED FOR REVIEW AND APPROVAL BY THE OWNER'S REPRESENTATIVE PRIOR TO COMMENCEMENT OF INSTALLATION. ANY REQUIRED ADJUSTMENTS TO THE LAYOUT SHALL BE UNDERTAKEN AS DIRECTED AT NO ADDITIONAL COST TO THE OWNER.
5. THE CONTRACTOR SHALL VERIFY ALL DIMENSIONS AND GRADES ON THE GROUND AND REPORT ANY DISCREPANCIES IMMEDIATELY TO THE OWNER AND OWNER'S REPRESENTATIVE.
6. LAYOUT AND DIMENSIONS PROVIDED FOR BIDDING PURPOSES ONLY. CONTRACTOR SHALL COORDINATE WITH OWNER'S REPRESENTATIVE FOR FINAL LAYOUT AND DIMENSION PLAN.

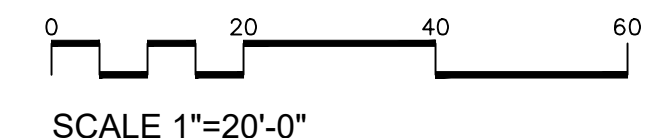
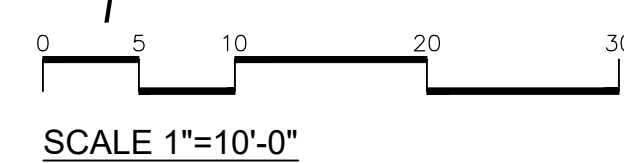
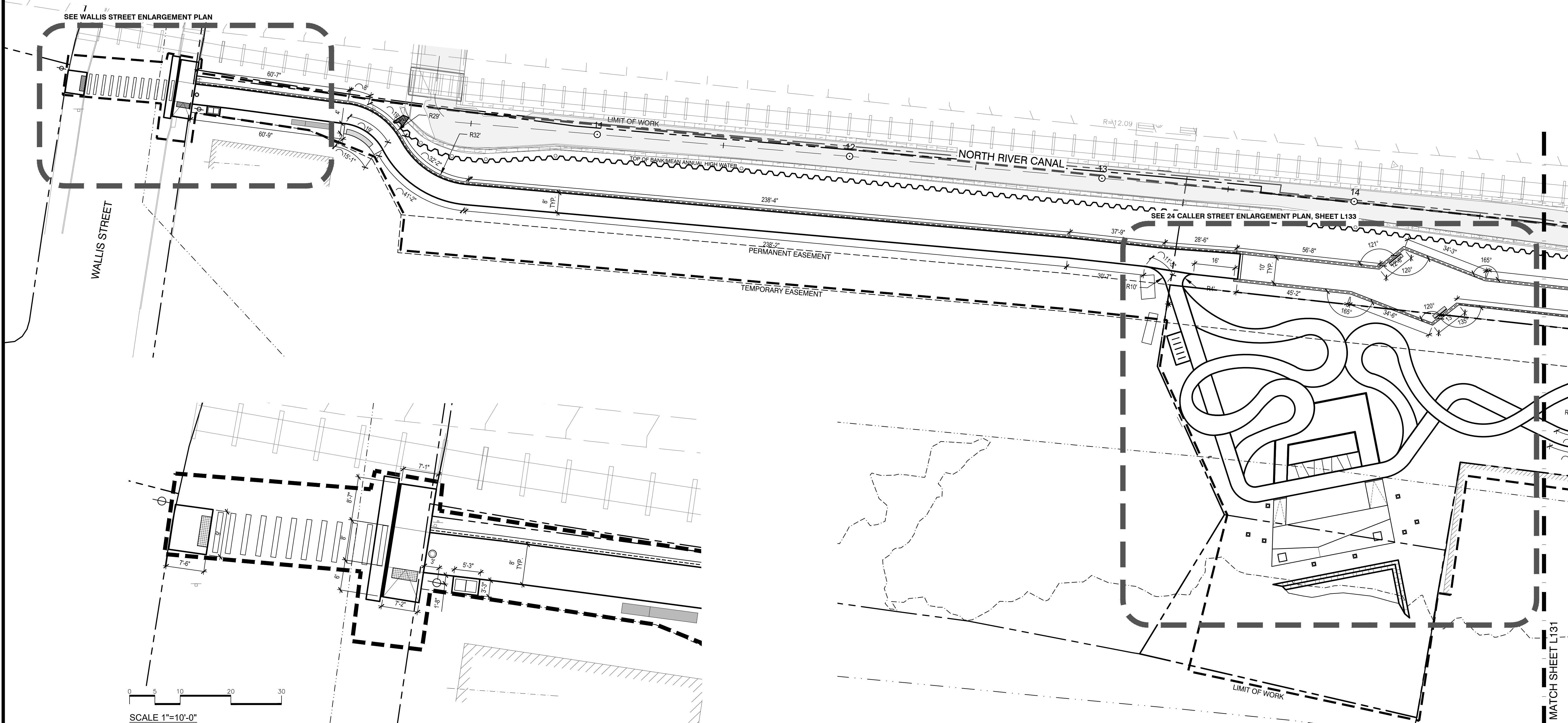

1 WALLIS ST ENLARGEMENT PLAN  
SCALE: 1" = 10'-0"

Project:  
 PEABODY RIVERWALK  
 RIVERWALK PARK

WALLIS STREET -  
 CALLER STREET -  
 HOWLEY STREET  
 PEABODY, MA. 01960

**Weston & Sampson**  
 WESTON & SAMPSON ENGINEERS, INC.  
 85 DEVONSHIRE STREET, 3RD FLOOR  
 BOSTON, MA 02109  
 617-412-4480  
 www.westonandsampson.com

Consultants:

Revisions:

No.	Date	Description

Seal:

Key Plan:

Issued For:  
 75% CONSTRUCTION DOCUMENTS  
 - NOT FOR CONSTRUCTION -

Scale: AS SHOWN  
 Date: APRIL 2021  
 Drawn By: FD, TY, SG  
 Reviewed By: CC  
 Approved By: CFR

W&S Project No.: ENG20-0145  
 W&S File No.:

Drawing Title:  
 LAYOUT PLAN

Sheet Number:  
 L130



**LEGEND**

	PROPERTY LINE
	LIMIT OF WORK
	EASEMENTS
	100' WETLAND BUFFER
	100' RIVERFRONT PROTECTION AREA
	APPROXIMATE LIMIT OF EXISTING 100-YEAR FLOOD PLAIN
	CENTER LINE
	TYP. DIMENSION
	TYP. ARC DIMENSION
	TYP. RADIUS
	TYP. ANGLE DIMENSION

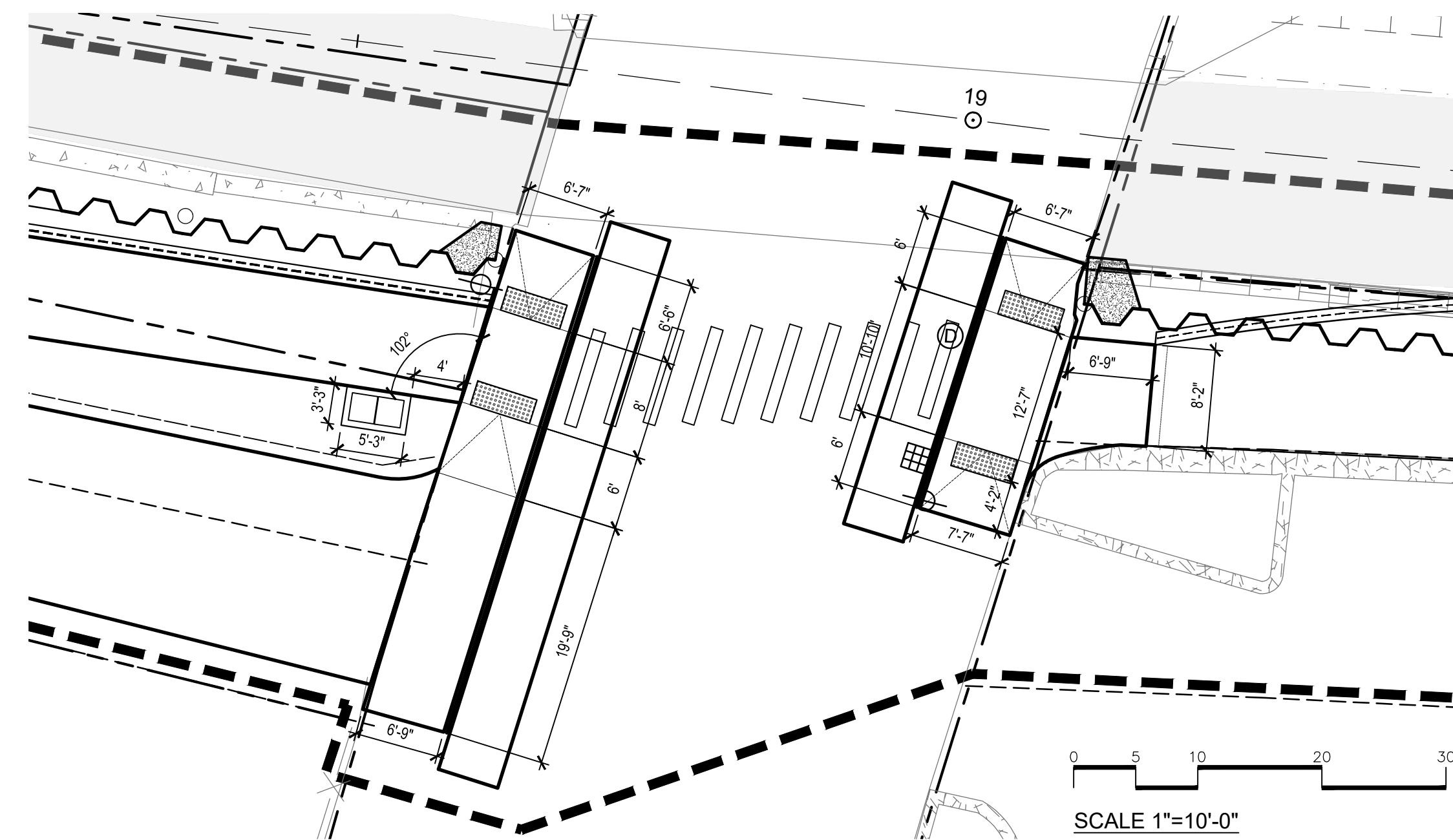

**1** CALLER STREET ENLARGEMENT PLAN  
SCALE: 1" = 10'-0"

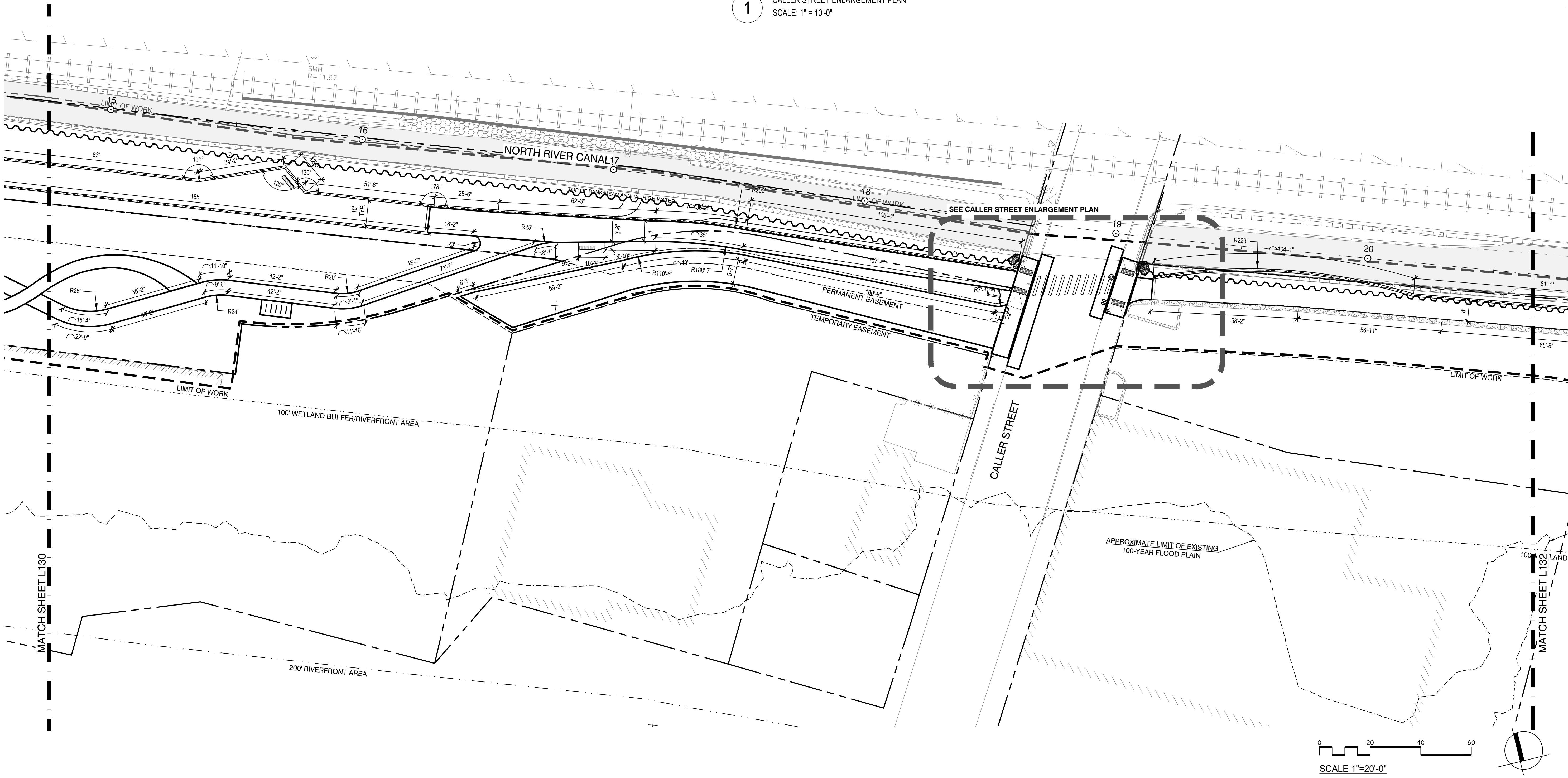

SCALE 1" = 20'-0"

Project:  
PEABODY RIVERWALK  
RIVERWALK PARK

WALLIS STREET -  
CALLER STREET -  
HOWLEY STREET  
PEABODY, MA. 01960

**Weston & Sampson**  
WESTON & SAMPSON ENGINEERS, INC.  
85 DEVONSHIRE STREET, 3RD FLOOR  
BOSTON, MA 02109  
617-412-4480  
www.westonandsampson.com

Consultants:

--

Revisions:

No.	Date	Description

Seal:

Key Plan:

Issued For:

**75% CONSTRUCTION DOCUMENTS**  
**- NOT FOR CONSTRUCTION -**

Scale: AS SHOWN

Date: APRIL 2021

Drawn By: FD, TY, SG

Reviewed By: CC

Approved By: CFR

W&S Project No.: ENG20-0145

W&S File No.:

Drawing Title:

**LAYOUT PLAN**

Sheet Number:

**L131**

PEABODY RIVERWALK PARK - WESTON & SAMPSON ENGINEERS, INC. - 100% ARCHITECTURAL



**LEGEND**

	PROPERTY LINE
	LIMIT OF WORK
	EASEMENTS
	100' WETLAND BUFFER
	100' RIVERFRONT PROTECTION AREA
	APPROXIMATE LIMIT OF EXISTING 100-YEAR FLOOD PLAIN
	CENTER LINE
	TYP. DIMENSION
	TYP. ARC DIMENSION
	TYP. RADIUS
	TYP. ANGLE DIMENSION

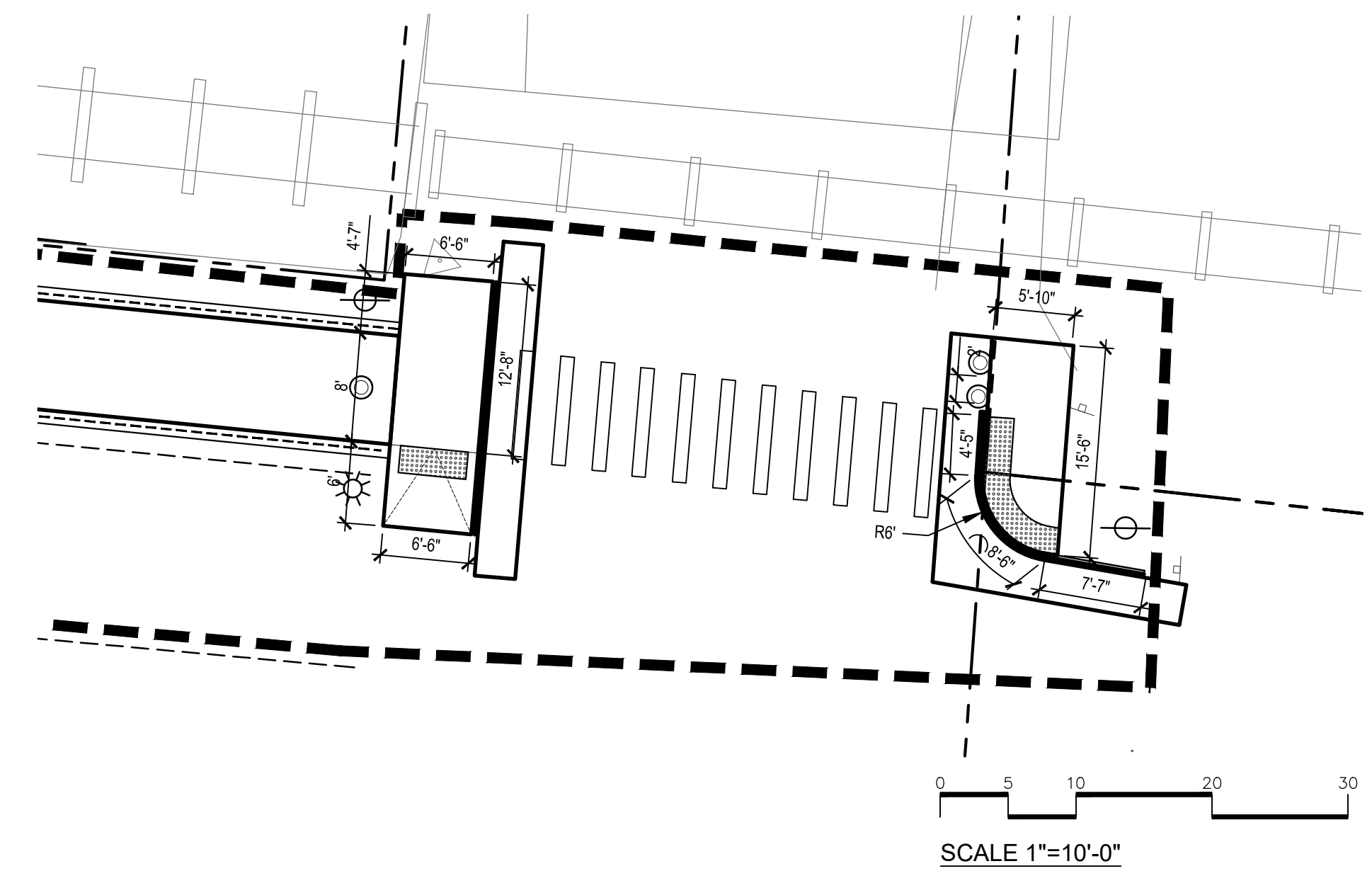

1 HOWLEY STREET ENLARGEMENT PLAN  
SCALE: 1" = 10'-0"

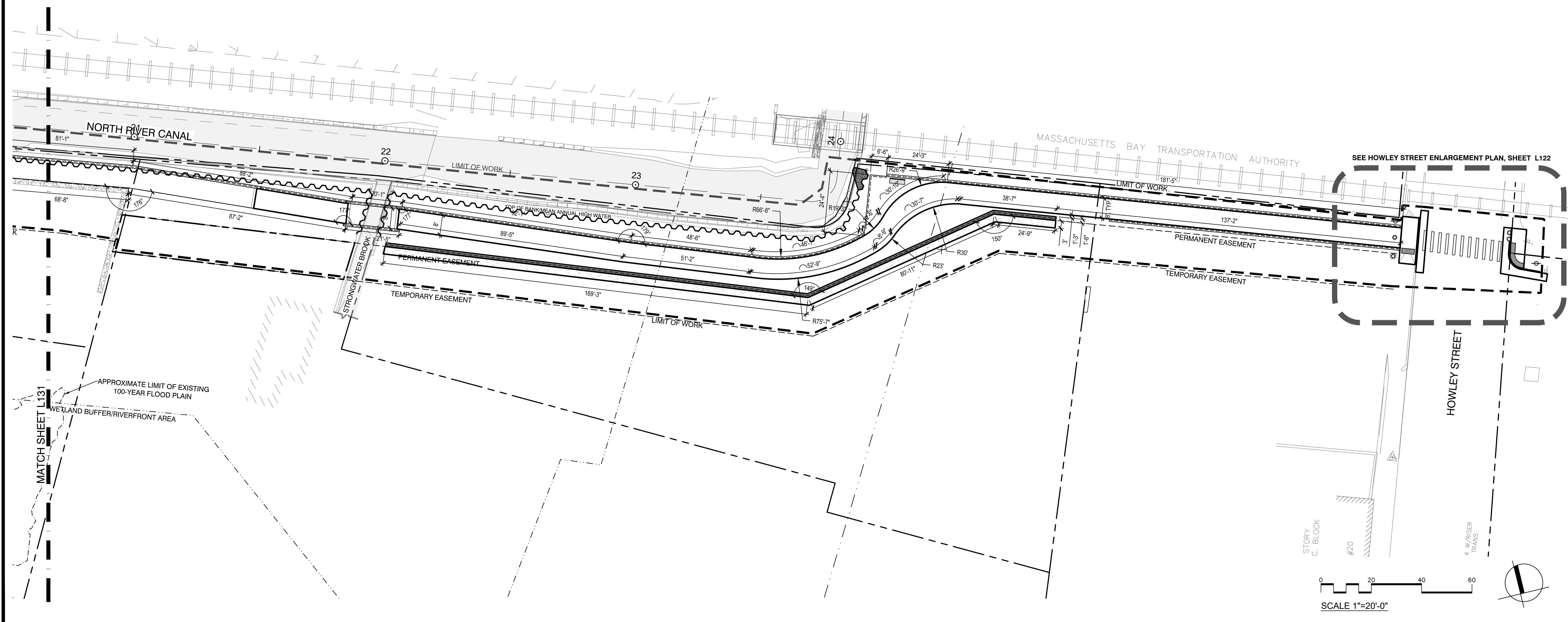

Project:  
PEABODY RIVERWALK  
RIVERWALK PARK

WALLIS STREET -  
CALLER STREET -  
HOWLEY STREET  
PEABODY, MA. 01960

**Weston & Sampson**  
WESTON & SAMPSON ENGINEERS, INC.  
85 DEVONSHIRE STREET, 3RD FLOOR  
BOSTON, MA 02109  
617-412-4480  
www.westonandsampson.com

Consultants:

Revisions:

No.	Date	Description

Key Plan:

Issued For:  
**75% CONSTRUCTION DOCUMENTS  
- NOT FOR CONSTRUCTION -**

Scale:	1" = 10'
Date:	APRIL 2021
Drawn By:	FD, TY, SG
Reviewed By:	CC
Approved By:	CFR
W&S Project No.:	ENG20-0145
W&S File No.:	

Drawing Title:  
**LAYOUT PLAN**

Sheet Number:  
**L132**



**LEGEND**

- — — — — PROPERTY LINE
- — — — — LIMIT OF WORK
- - - - - EASEMENTS
- - - - - 100' WETLAND BUFFER
- - - - - 100' RIVERFRONT PROTECTION AREA
- - - - - APPROXIMATE LIMIT OF EXISTING 100-YEAR FLOOD PLAIN
- - - - - CENTER LINE
- X-X" TYP. DIMENSION
- X-X" TYP. ARC DIMENSION
- RX" TYP. RADIUS
- ∠ TYP. ANGLE DIMENSION

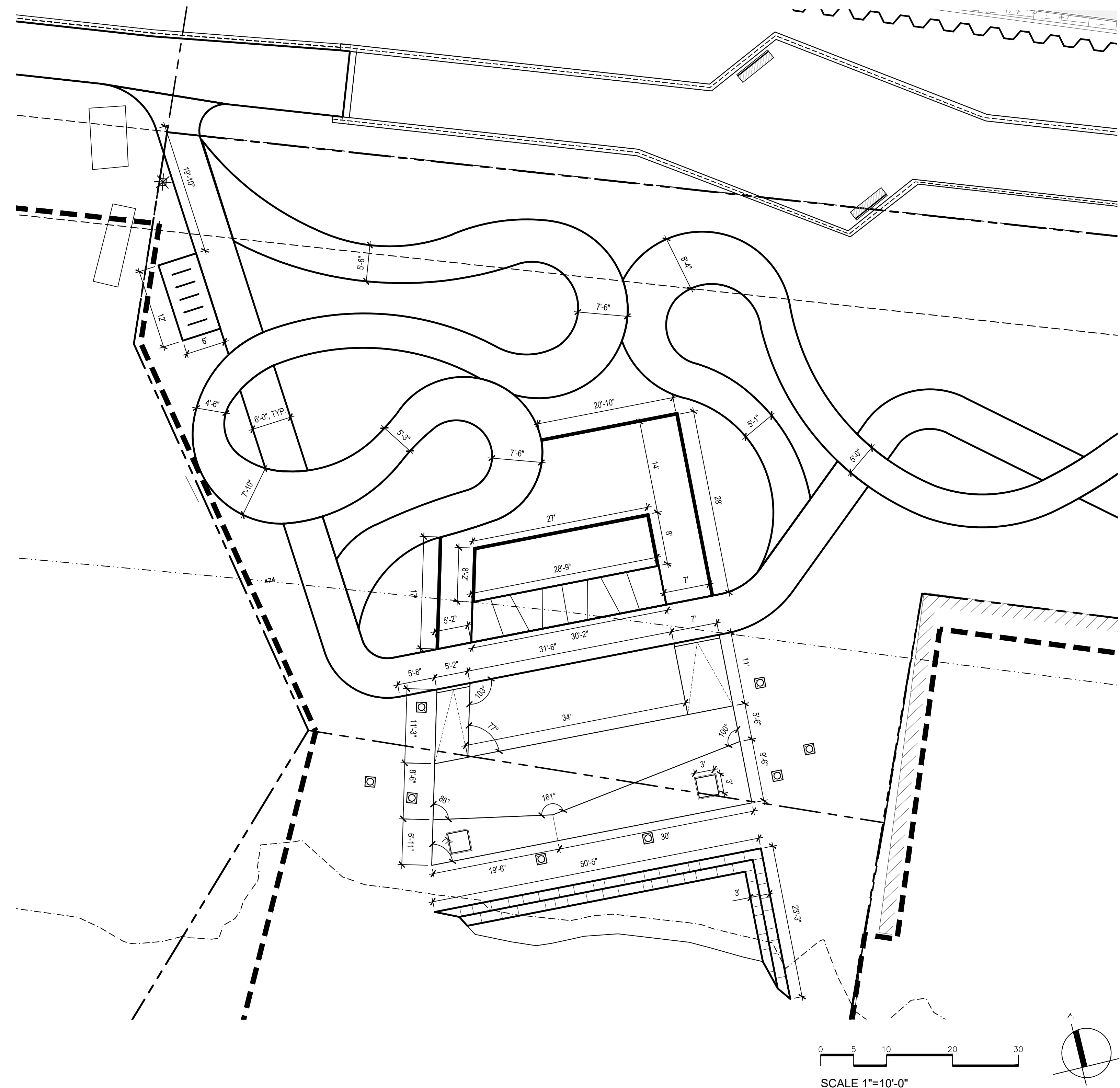

1 24 CALLER STREET ENLARGEMENT PLAN  
SCALE: 1" = 10'-0"

Project:  
PEABODY RIVERWALK  
RIVERWALK PARK

WALLIS STREET -  
CALLER STREET -  
HOWLEY STREET  
PEABODY, MA. 01960

**Weston & Sampson**  
WESTON & SAMPSON ENGINEERS, INC.  
85 DEVONSHIRE STREET, 3RD FLOOR  
BOSTON, MA 02109  
617-412-4480  
www.westonandsampson.com

Consultants:

Revisions:

No.	Date	Description

Seal:

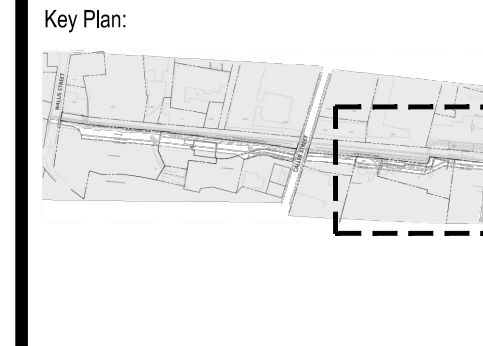

Issued For:  
**75% CONSTRUCTION DOCUMENTS**  
**- NOT FOR CONSTRUCTION -**

Scale: AS SHOWN  
Date: APRIL 2021  
Drawn By: FD, TY, SG  
Reviewed By: CC  
Approved By: CFR

W&S Project No.: ENG20-0145  
W&S File No.:

Drawing Title:  
**LAYOUT PLAN**

Sheet Number:  
**L133**



**LEGEND**

	PROPERTY LINE		PROPOSED CONTOURS
	LIMIT OF WORK		PROPOSED SLOPE
	EASEMENTS		PROPOSED SPOT ELEVATION
	100' WETLAND BUFFER		GRADE BREAK
	200' RIVERFRONT PROTECTION AREA		HIGH POINT
	APPROXIMATE LIMIT OF EXISTING 100-YEAR FLOOD PLAIN		LOW POINT
	EXISTING DRAINAGE STRUCTURE. SEE UTILITIES PLAN		TOP OF WALL
	EXISTING CONTOURS		BOTTOM OF WALL
	EXISTING SPOT ELEVATION		ELEVATION

**GRADING & DRAINAGE NOTES**

- ALL WORK RELATING TO INSTALLATION, RENOVATION OR MODIFICATION OF WATER, UTILITY STORMWATER DRAINAGE AND/OR SEPTIC UTILITIES SHALL BE PERFORMED IN ACCORDANCE WITH THE STANDARDS OF THE CITY, AND STATE OF MASSACHUSETTS.
- THE CONTRACTOR SHALL VERIFY ALL GRADES ON THE GROUND AND REPORT ANY DISCREPANCIES IMMEDIATELY TO THE OWNER'S REPRESENTATIVE.
- ALL GRADING IS TO BE SMOOTH AND CONTINUOUS WHERE PROPOSED SURFACE MEETS EXISTING SURFACE. BLEND THE TWO PAVEMENTS AND ELIMINATE ROUGH SPOTS AND ABRUPT GRADE CHANGES AND MEET LINE AND GRADE OF EXISTING CONDITIONS WITH NEW IMPROVEMENTS.
- CONTRACTOR SHALL ENSURE ALL AREAS ARE PROPERLY PITCHED TO DRAIN, WITH NO SURFACE WATER PONDING OR PUDDLING.
- ALL NEW WALKWAYS MUST CONFORM TO CURRENT AMERICANS WITH DISABILITIES ACT (ADA), AND MASSACHUSETTS ARCHITECTURAL ACCESS BOARD (MAAB) REGULATIONS. WALKWAYS SHALL MAINTAIN A CROSS PITCH OF NOT MORE THAN ONE AND A HALF (1.5%) PERCENT AND THE RUNNING SLOPE (PARALLEL TO THE DIRECTION OF TRAVEL) BETWEEN 1% MIN. AND 4.5% MAX. ANY DISCREPANCIES NOT ALLOWING THIS TO OCCUR SHALL BE REPORTED TO THE OWNER'S REPRESENTATIVE PRIOR TO CONTINUING WORK.
- ALL UTILITY GRATES, COVERS OR OTHER SURFACE ELEMENTS INTENDED TO BE EXPOSED AT GRADE SHALL BE FLUSH WITH THE ADJACENT FINISHED GRADE AND ADJUSTED TO PROVIDE A SMOOTH TRANSITION AT ALL EDGES.
- THE CONTRACTOR SHALL CONFIRM AND/OR SET SUBGRADE ELEVATIONS TO ALLOW FOR POSITIVE DRAINAGE AND PROVIDE EROSION CONTROL DEVICES, STRUCTURES, MATERIALS AND CONSTRUCTION METHODS TO DIRECT SILT MIGRATION AWAY FROM DRAINAGE AND OTHER UTILITY SYSTEMS, PUBLIC/PRIVATE STREETS AND WORK AREAS. CLEAN BASINS REGULARLY AND AT THE END OF THE PROJECT.
- EXCAVATION REQUIRED WITHIN PROXIMITY OF KNOWN EXISTING UTILITY LINES SHALL BE DONE BY HAND. CONTRACTOR SHALL REPAIR ANY DAMAGE TO EXISTING UTILITY LINES OR STRUCTURES INCURRED DURING CONSTRUCTION OPERATIONS AT NO COST TO THE OWNER.
- WHERE NEW EARTHWORK MEETS EXISTING EARTHWORK, CONTRACTOR SHALL BLEND NEW EARTHWORK SMOOTHLY INTO EXISTING, PROVIDING VERTICAL CURVES OR ROUNDS AT ALL TOP AND BOTTOM OF SLOPES.
- WHERE A SPECIFIC LIMIT OF WORK LINE IS NOT OBVIOUS OR IMPLIED, BLEND GRADES TO EXISTING CONDITIONS WITHIN 5 FEET OF PROPOSED CONTOURS.
- RESTORE ALL DISTURBED AREAS AND LIMITS OF ALL REMOVALS TO LOAM AND SEED UNLESS OTHERWISE NOTED.
- SEE EARTHWORK SECTION OF SPECIFICATIONS FOR EXCAVATION AND FILLING PROCEDURES.

Project:  
**PEABODY RIVERWALK RIVERWALK PARK**  
  
 WALLIS STREET - CALLER STREET - HOWLEY STREET  
 PEABODY, MA. 01960

**Weston & Sampson**  
 WESTON & SAMPSON ENGINEERS, INC.  
 85 DEVONSHIRE STREET, 3RD FLOOR  
 BOSTON, MA 02109  
 617-412-4480  
 www.westonandsampson.com

Consultants:  
 \_\_\_\_\_

Revisions:

No.	Date	Description

Seal:  
 \_\_\_\_\_

Key Plan:

Issued For:  
**75% CONSTRUCTION DOCUMENTS**  
**- NOT FOR CONSTRUCTION -**

Scale: 1" = 20'

Date: APRIL 2021

Drawn By: FD, TY, SG

Reviewed By: CC

Approved By: CFR

W&S Project No.: ENG20-0145  
 W&S File No.: \_\_\_\_\_

Drawing Title:  
**GRADING AND DRAINAGE PLAN**

Sheet Number:  
**L140**

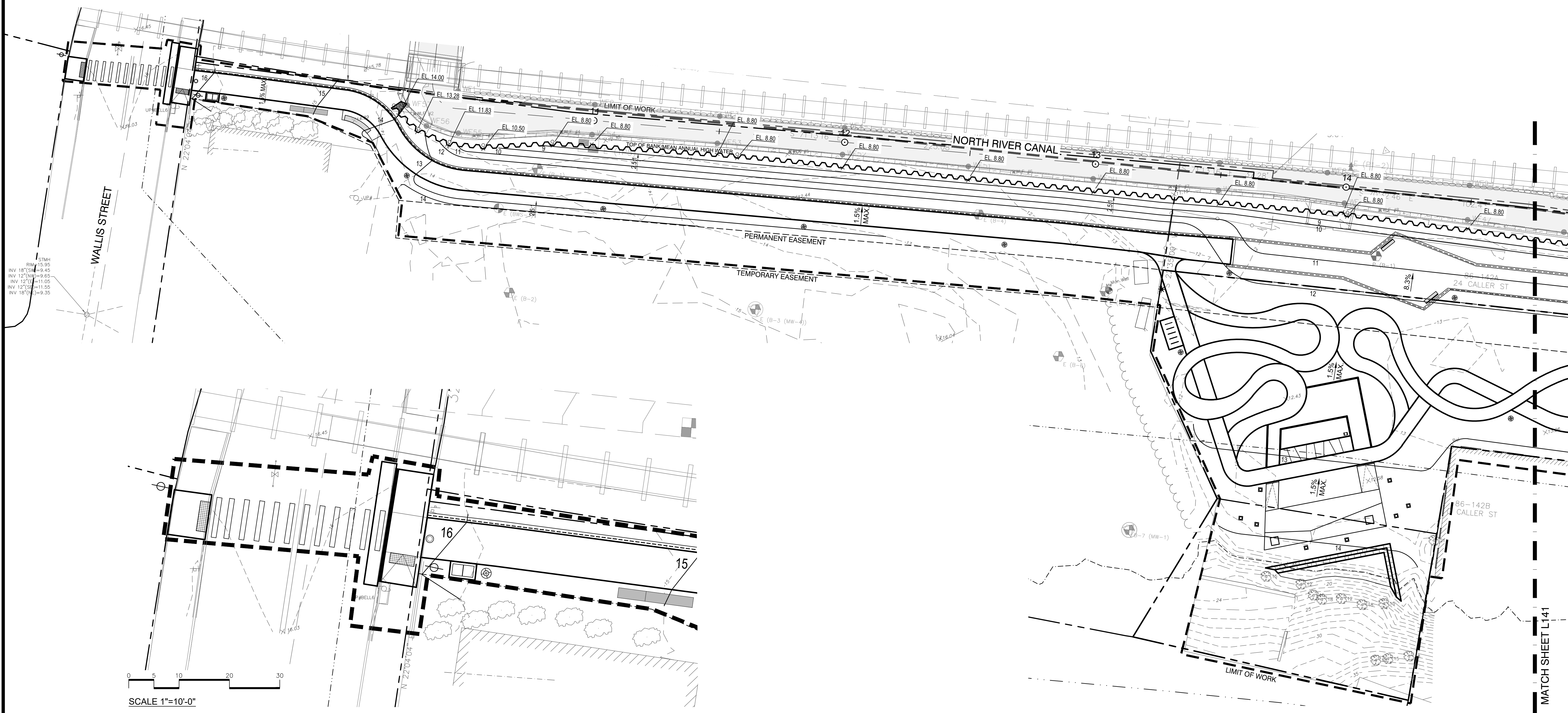

1 WALLIS ST ENLARGEMENT PLAN  
 SCALE: 1" = 10'-0"



**LEGEND**

	PROPERTY LINE		PROPOSED CONTOURS
	LIMIT OF WORK		PROPOSED SLOPE
	EASEMENTS		PROPOSED SPOT ELEVATION
	100' WETLAND BUFFER		
	200' RIVERFRONT PROTECTION AREA		HDPE PERFORATED DRAIN PIPE, DIAMETER VARIES
	APPROXIMATE LIMIT OF EXISTING 100-YEAR FLOOD PLAIN		GRADE BREAK
	EXISTING DRAINAGE STRUCTURE. SEE UTILITIES PLAN		HIGH POINT
			LOW POINT
			TOP OF WALL
			BOTTOM OF WALL
			ELEVATION
	EXISTING CONTOURS		
	EXISTING SPOT ELEVATION		

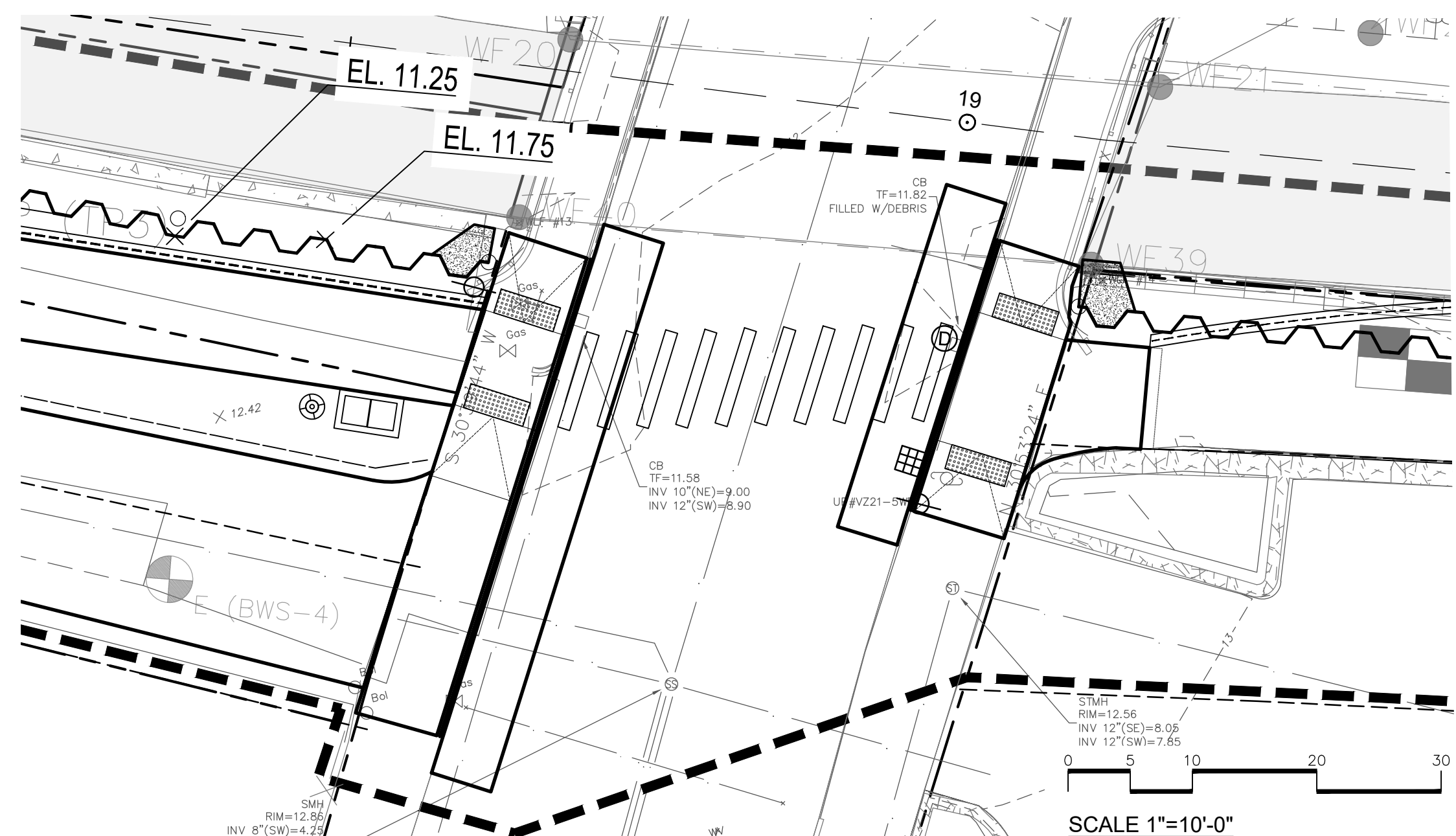

**1** CALLER STREET ENLARGEMENT PLAN  
SCALE: 1" = 10'-0"

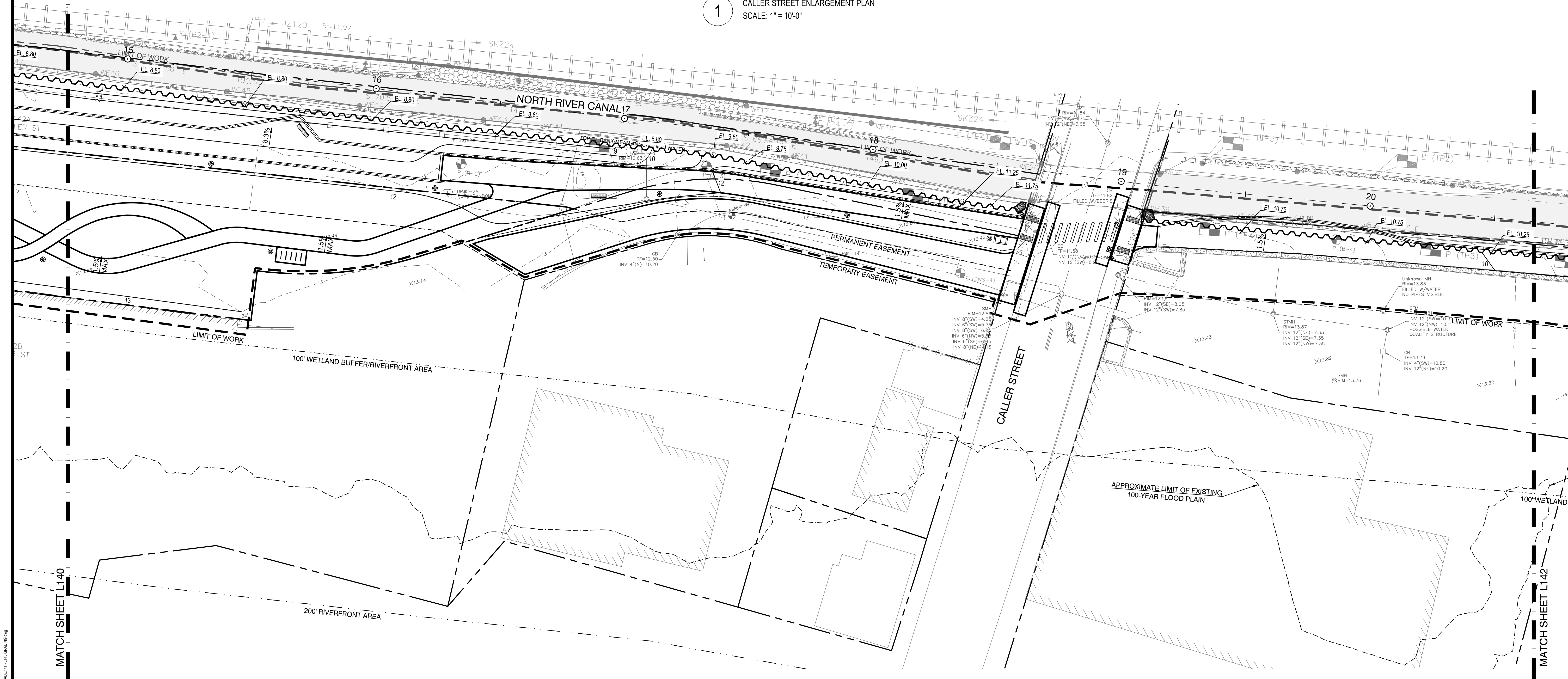

SCALE 1"=20'-0"

Project:  
PEABODY RIVERWALK  
RIVERWALK PARK

WALLIS STREET -  
CALLER STREET -  
HOWLEY STREET  
PEABODY, MA. 01960

**Weston & Sampson**  
WESTON & SAMPSON ENGINEERS, INC.  
85 DEVONSHIRE STREET, 3RD FLOOR  
BOSTON, MA 02109  
617-412-4480  
www.westonandsampson.com

Consultants:

--

Revisions:

No.	Date	Description

Seal:

Key Plan:

Issued For:

**75% CONSTRUCTION DOCUMENTS**  
**- NOT FOR CONSTRUCTION -**

Scale: 1" = 20'

Date: APRIL 2021

Drawn By: FD, TY, SG

Reviewed By: CC

Approved By: CFR

W&S Project No.: ENG20-0145

W&S File No.:

Drawing Title:

**GRADING AND DRAINAGE PLAN**

Sheet Number:

**L141**



**LEGEND**

	PROPERTY LINE		PROPOSED CONTOURS
	LIMIT OF WORK		PROPOSED SLOPE
	EASEMENTS		PROPOSED SPOT ELEVATION
	100' WETLAND BUFFER		HDPE PERF. DRAIN PIPE
	200' RIVERFRONT PROTECTION AREA		HDPE PERFORATED DRAIN PIPE, DIAMETER VARIES
	APPROXIMATE LIMIT OF EXISTING 100-YEAR FLOOD PLAIN		GRADE BREAK
	EXISTING DRAINAGE STRUCTURE. SEE UTILITIES PLAN		HIGH POINT
			LOW POINT
			TOP OF WALL
			BOTTOM OF WALL
			ELEVATION
	EXISTING CONTOURS		
	EXISTING SPOT ELEVATION		

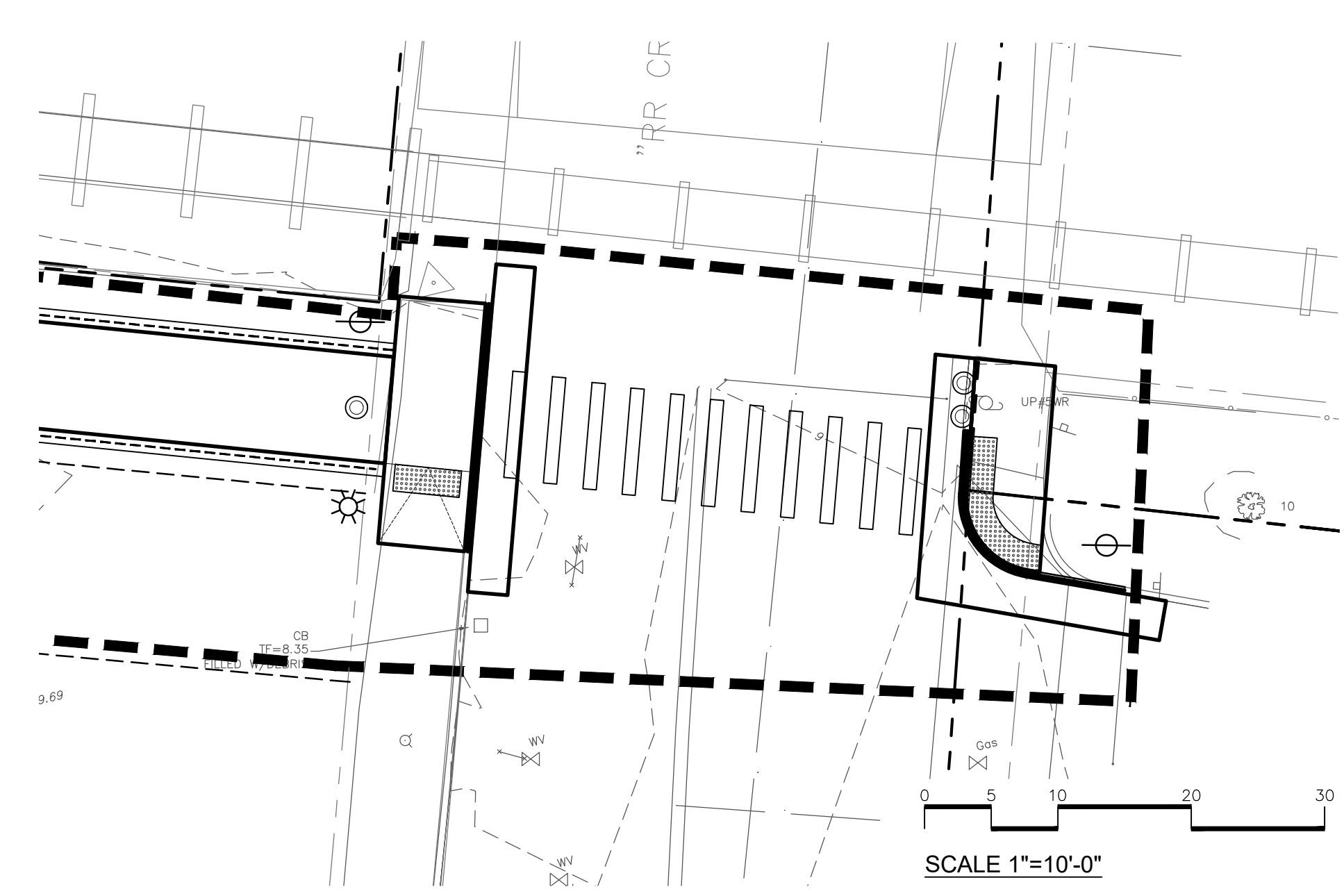

**1** HOWLEY STREET ENLARGEMENT PLAN  
SCALE: 1" = 10'-0"

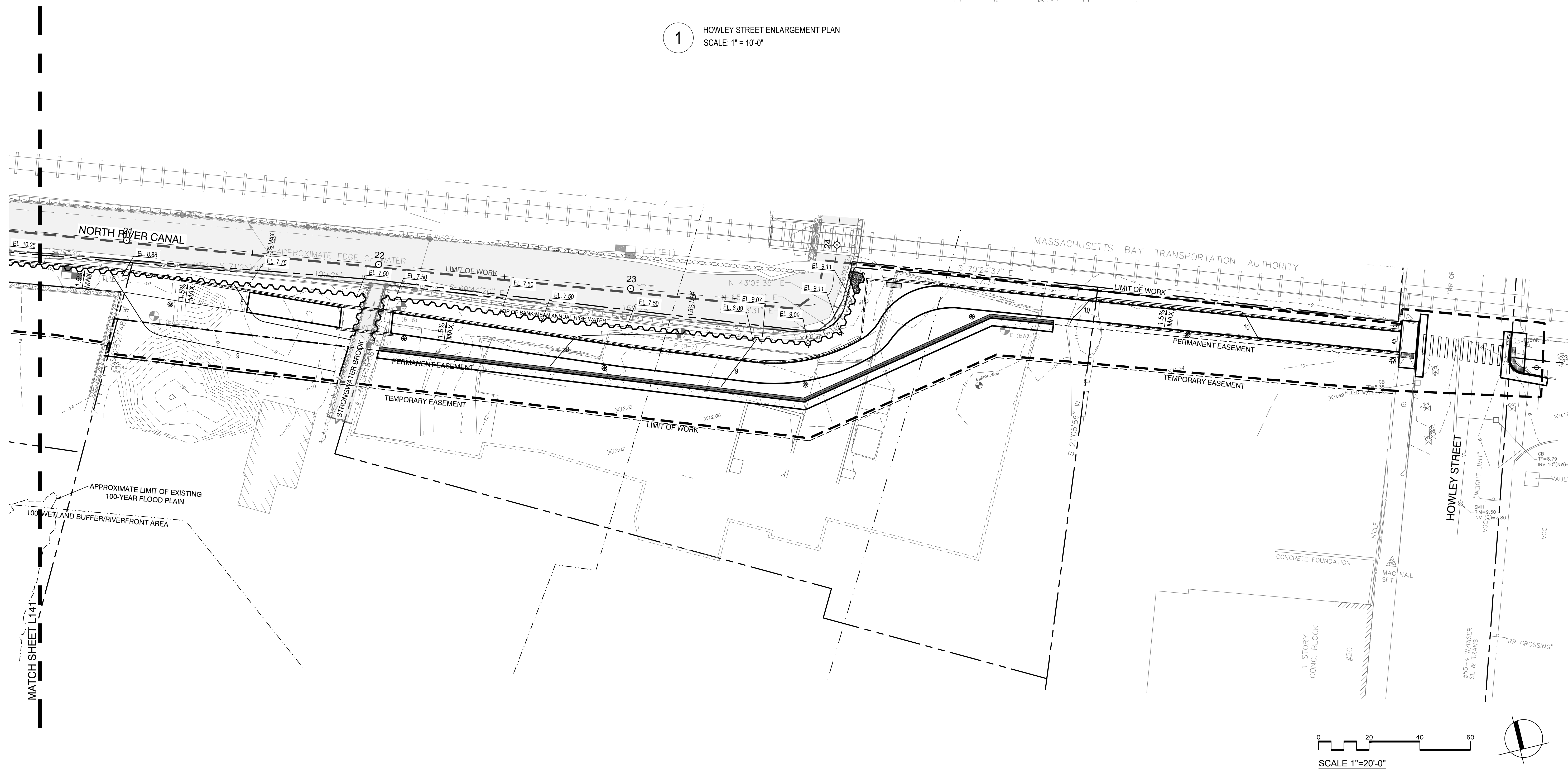

Project:  
**PEABODY RIVERWALK RIVERWALK PARK**  
  
 WALLIS STREET - CALLER STREET - HOWLEY STREET  
 PEABODY, MA. 01960

**Weston & Sampson**  
 WESTON & SAMPSON ENGINEERS, INC.  
 85 DEVONSHIRE STREET, 3RD FLOOR  
 BOSTON, MA 02109  
 617-412-4480  
 www.westonandsampson.com

Consultants:

Revisions:

No.	Date	Description

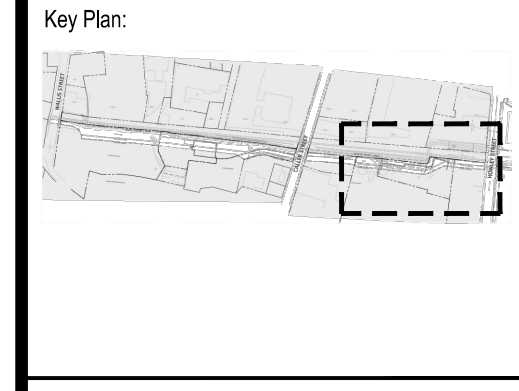

Issued For:  
**75% CONSTRUCTION DOCUMENTS**  
**- NOT FOR CONSTRUCTION -**

Scale: 1" = 20'

Date: APRIL 2021

Drawn By: FD, TY, SG

Reviewed By: CC

Approved By: CFR

W&S Project No.: ENG20-0145

W&S File No.:

Drawing Title:  
**GRADING AND DRAINAGE PLANS**

Sheet Number:  
**L142**



**LEGEND**

- PROPERTY LINE
- LIMIT OF WORK
- EASEMENTS
- 100' WETLAND BUFFER
- 100' RIVERFRONT PROTECTION AREA
- APPROXIMATE LIMIT OF EXISTING 100-YEAR FLOOD PLAIN
- SHEET PILE WALL
- NO-MOW SEED MIX

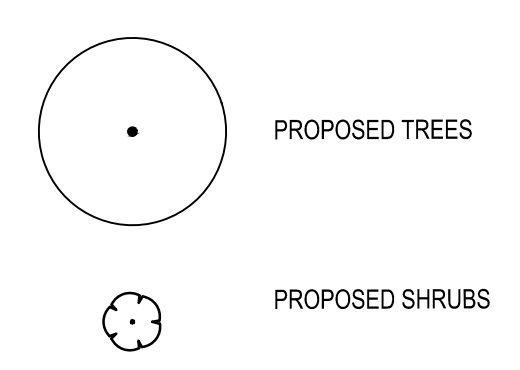

**PLANT SCHEDULE L150**

TREES	BOTANICAL NAME	COMMON NAME	SIZE	QTY	
AR	Acer rubrum	Red Maple	3" Cal.	7	
AS	Acer saccharum	Sugar Maple	---	6	
AC	Amelanchier canadensis 'Autumn Brilliance'	Autumn Brilliance Serviceberry	3" Cal.	4	
BN	Betula nigra 'Dura-Heat'	River Birch 'Dura-Heat'	3" Cal.	8	
BP	Betula papyrifera	Paper Birch	3" Cal.	2	
GT	Gleditsia triacanthos	Honey Locust	---	4	
MV	Magnolia virginiana	Sweet Bay	3" Cal.	4	
OV	Ostrya virginiana	American Hophornbeam	3" Cal.	3	
QA	Quercus alba	White Oak	3" Cal.	3	
QR	Quercus rubra	Red Oak	---	3	
SHRUBS	BOTANICAL NAME	COMMON NAME	SIZE	QTY	
CO	Cephalanthus occidentalis	Buttonbush	#2 Pot	1	
CA	Clethra alnifolia	Summersweet	#3 Pot	2	
CR	Cornus racemosa	Gray Dogwood	#3 Pot	4	
HV	Hamamelis virginiana	Common Witch Hazel	#3 Pot	4	
IV	Ilex verticillata 'Winter Red'	Winterberry 'Winter Red'	#3 Pot	6	
II	Itea virginica	Virginia Sweetspire	#2 Pot	5	
VL	Viburnum lentago	Nannyberry	#3 Pot	2	
SHRUB AREAS	BOTANICAL NAME	COMMON NAME	SIZE	SPACING	QTY
RA	Rhus aromatica 'Gro-Low'	Fragrant Sumac 'Gro-Low'	#3 Pot	36" o.c.	114
GROUND COVERS	BOTANICAL NAME	COMMON NAME	SIZE	SPACING	QTY
AM	Achillea millefolium	Common Yarrow	1 gal.	24" o.c.	196
CP	Carex pensylvanica	---	---	10" o.c.	2,207
DP	Dalea purpurea	---	---	24" o.c.	61
DU	Denistaedia punctilobula	Hay-scented Fern	---	30" o.c.	124
DT	Deschampsia cespitosa	Tufted Hair Grass	---	24" o.c.	71
EP	Echinacea purpurea	---	---	24" o.c.	130
EU	Eutrochium purpureum	---	---	48" o.c.	39
OC	Osmunda cinnamomea	---	---	30" o.c.	82
OR	Osmunda regalis	---	---	36" o.c.	55
SS	Schizachyrium scoparium	Little Bluestem	---	18" o.c.	94
SN	Solidago nemoralis	---	---	24" o.c.	181
VH	Verbena hastata	Blue Vervain	---	24" o.c.	44
SEEDING	BOTANICAL NAME	COMMON NAME	SIZE	SPACING	QTY
NMLM	No Mow Lawn Mix	---	---	---	12,764 sf

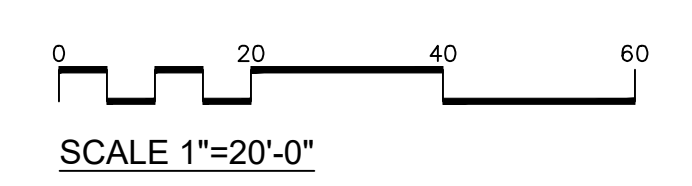
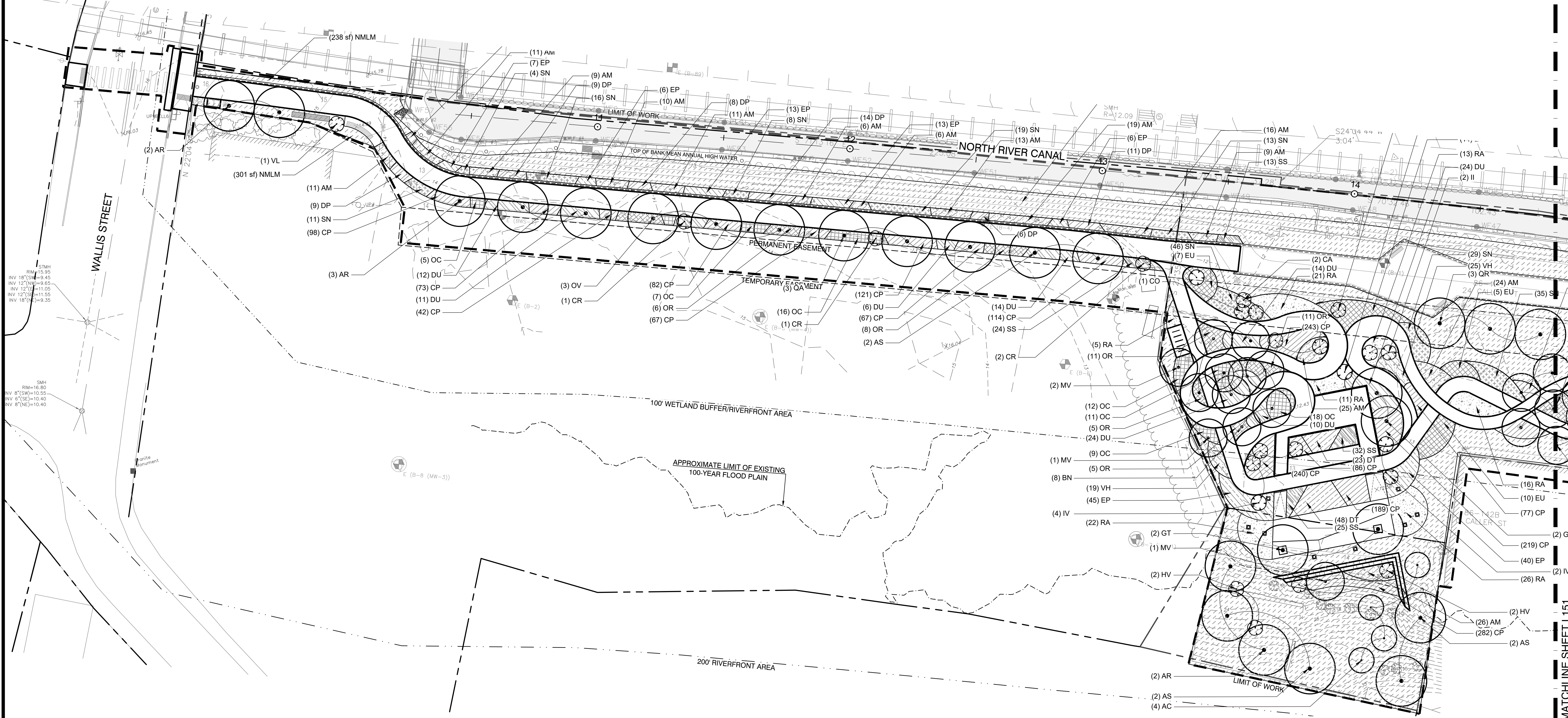

Project:  
**PEABODY RIVERWALK**  
 RIVERWALK PARK

WALLIS STREET -  
 CALLER STREET -  
 HOWLEY STREET  
 PEABODY, MA. 01960

**Weston & Sampson**  
 WESTON & SAMPSON ENGINEERS, INC.  
 85 DEVONSHIRE STREET, 3RD FLOOR  
 BOSTON, MA 02109  
 617-412-4480  
 www.westonandsampson.com

Consultants:

No.	Date	Description

Key Plan:

Issued For:  
**75% CONSTRUCTION DOCUMENTS**  
 - NOT FOR CONSTRUCTION -

Scale: 1" = 20'

Date: APRIL 2021

Drawn By: SG

Reviewed By: CC

Approved By:

W&S Project No.: ENG20-0145

W&S File No.:

Drawing Title:  
**PLANTING PLAN**

Sheet Number:  
**L150**



**LEGEND**

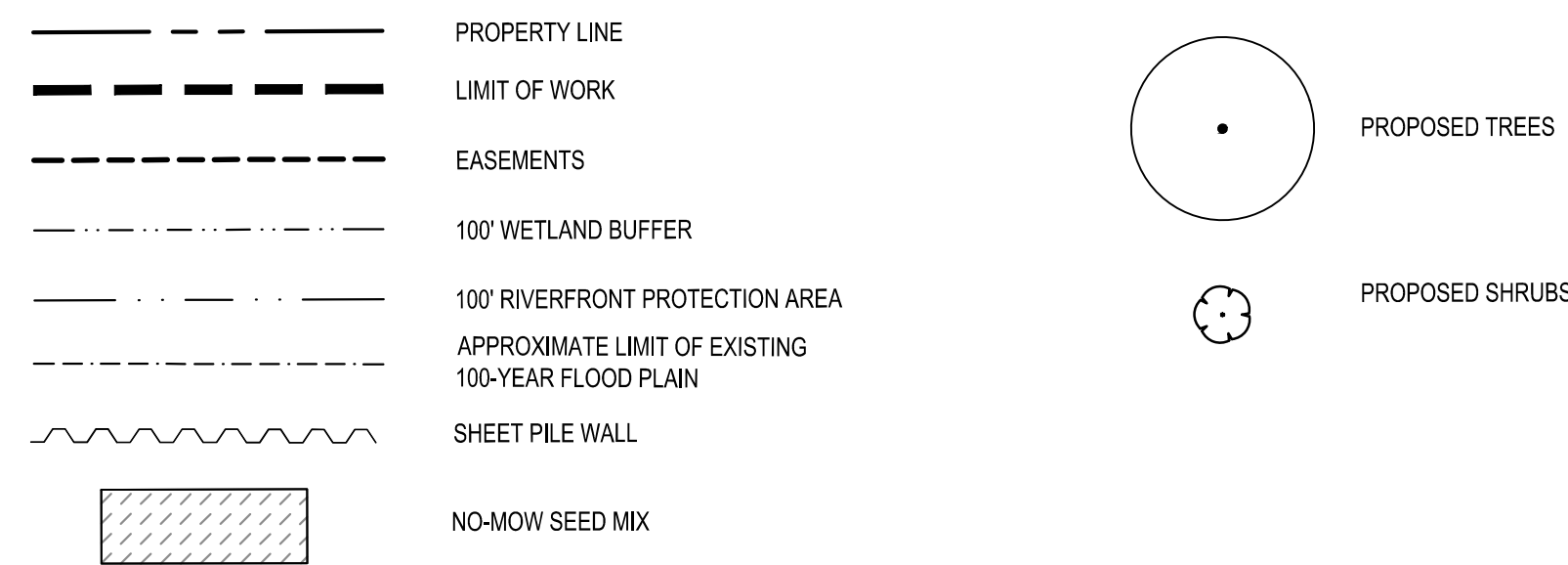

**PLANT SCHEDULE L151**

TREES	BOTANICAL NAME	COMMON NAME	SIZE	QTY
AR	Acer rubrum	Red Maple	3" Cal.	2
AS	Acer saccharum	Sugar Maple	---	3
BP	Betula papyrifera	Paper Birch	3" Cal.	14
GB	Ginkgo biloba	Maidenhair Tree	3" Cal.	2
QA	Quercus alba	White Oak	3" Cal.	2

SHRUB AREAS	BOTANICAL NAME	COMMON NAME	SIZE	SPACING	QTY
RA	Rhus aromatica "Gro-Low"	Fragrant Sumac "Gro-Low"	#3 Pot	36" o.c.	36

GROUND COVERS	BOTANICAL NAME	COMMON NAME	SIZE	SPACING	QTY
DU	Dennstaedtia punctilobula	Hay-scented Fern	---	30" o.c.	25
OC	Osmunda cinnamomea	---	---	30" o.c.	27
OR	Osmunda regalis	---	---	36" o.c.	30

SEEDING	BOTANICAL NAME	COMMON NAME	SIZE	SPACING	QTY
NMLM	No Mow Lawn Mix	---	---	---	8,777 sf

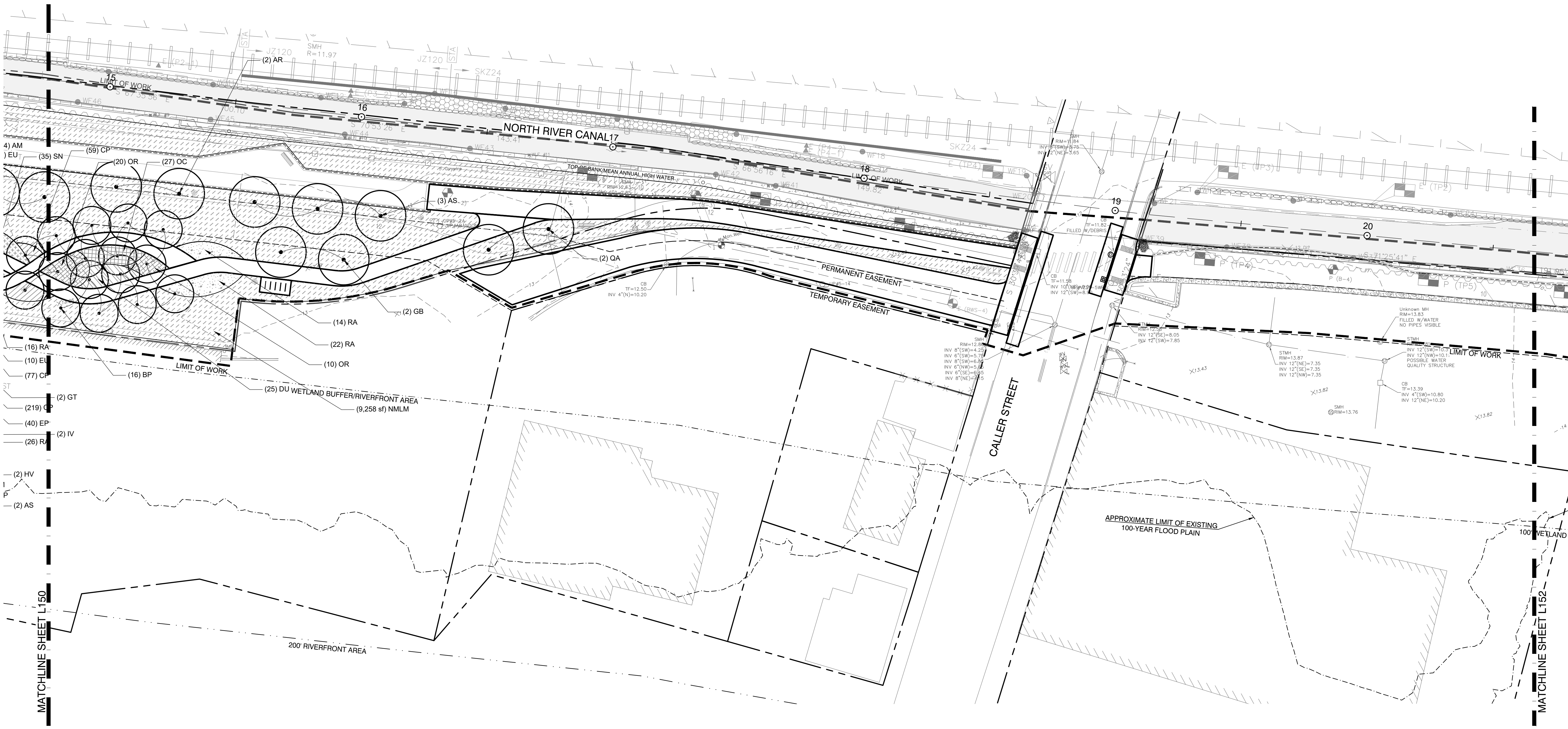

Project:  
**PEABODY RIVERWALK RIVERWALK PARK**  
  
 WALLIS STREET - CALLER STREET - HOWLEY STREET  
 PEABODY, MA. 01960

**Weston & Sampson**  
 WESTON & SAMPSON ENGINEERS, INC.  
 85 DEVONSHIRE STREET, 3RD FLOOR  
 BOSTON, MA 02109  
 617-412-4480  
 www.westonandsampson.com

Consultants:

Revisions:

No.	Date	Description

Seal:

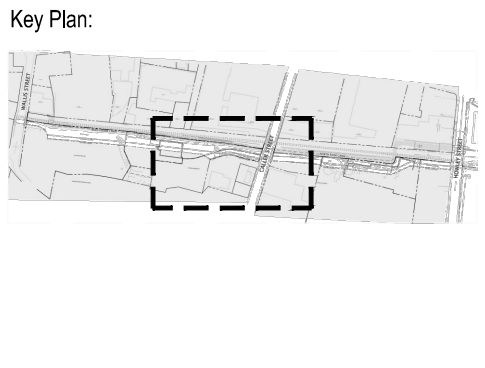

Issued For:  
**75% CONSTRUCTION DOCUMENTS**  
**- NOT FOR CONSTRUCTION -**

Scale: 1" = 20'  
 Date: APRIL 2021  
 Drawn By: FD, TY, SG  
 Reviewed By: CC  
 Approved By: CFR  
 W&S Project No.: ENG20-0145  
 W&S File No.:

Drawing Title:  
**PLANTING PLAN**

Sheet Number:  
**L151**

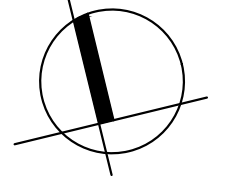
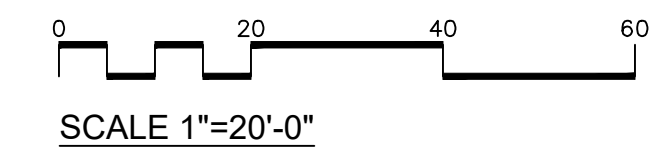

PEABODY RIVERWALK RIVERWALK PARK - CONSTRUCTION DOCUMENTS - SHEET L151



**LEGEND**

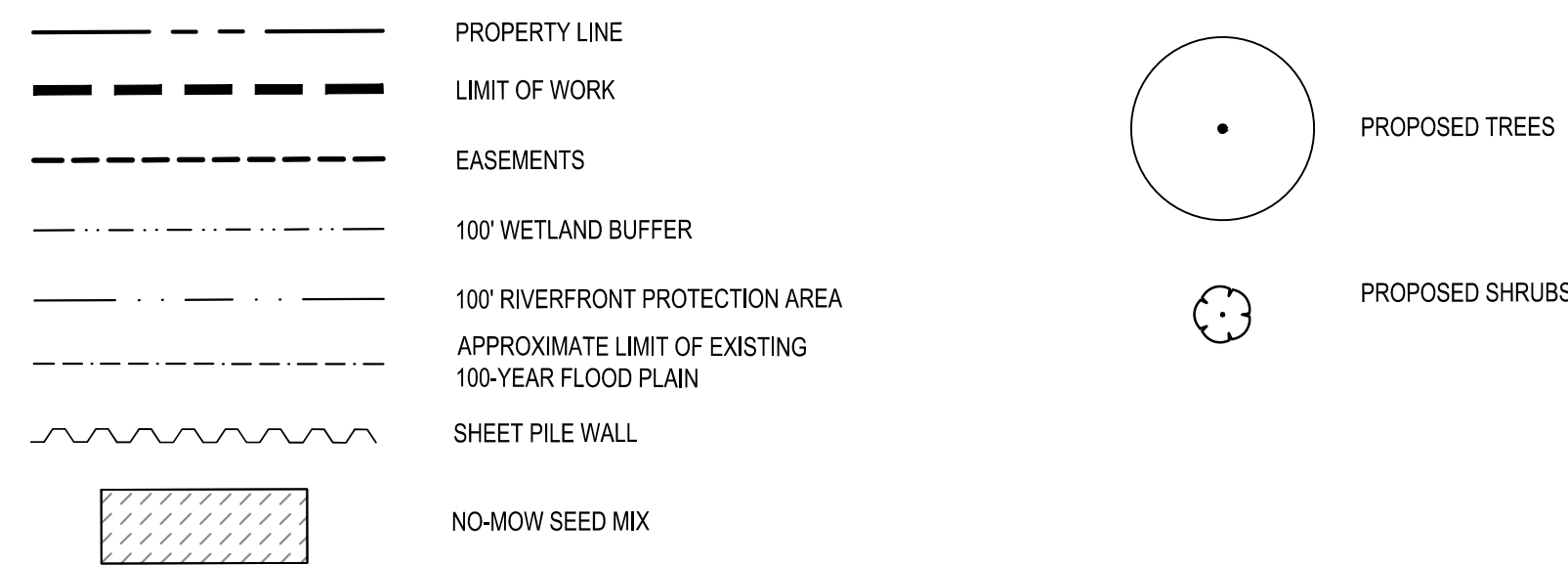

**PLANT SCHEDULE L152**

TREES	BOTANICAL NAME	COMMON NAME	SIZE	QTY
AR	Acer rubrum	Red Maple	3" Cal.	3
NS	Nyssa sylvatica	Sour Gum	3" Cal.	4

SEEDING	BOTANICAL NAME	COMMON NAME	SIZE	SPACING	QTY
NMLM	No Mow Lawn Mix		---		4,031 sf

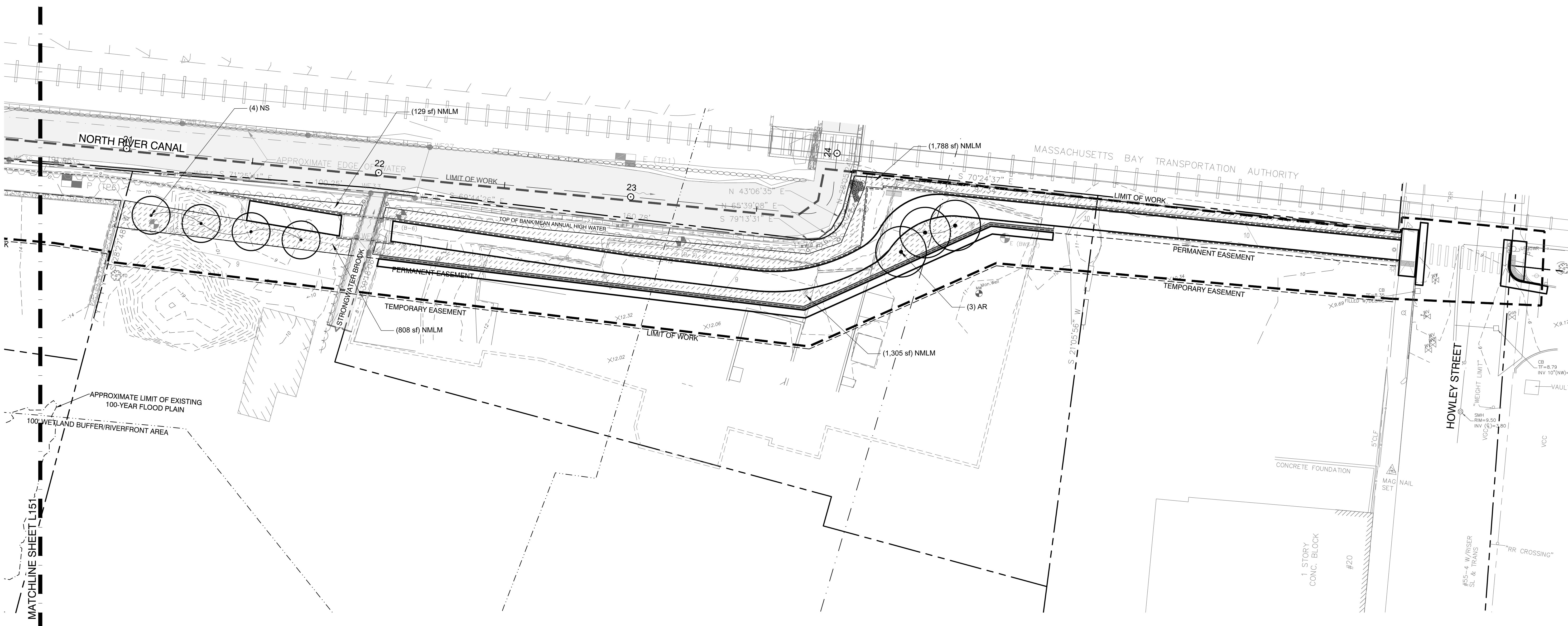

MATCHLINE SHEET L151

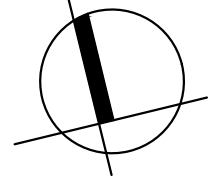
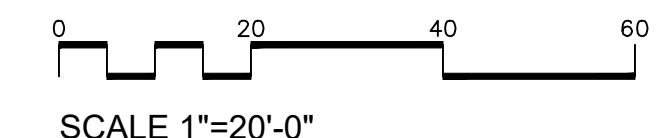

Project:  
**PEABODY RIVERWALK  
 RIVERWALK PARK**

WALLIS STREET -  
 CALLER STREET -  
 HOWLEY STREET  
 PEABODY, MA. 01960

**Weston & Sampson**  
 WESTON & SAMPSON ENGINEERS, INC.  
 85 DEVONSHIRE STREET, 3RD FLOOR  
 BOSTON, MA 02109  
 617-412-4480  
 www.westonandsampson.com

Consultants:

Revisions:

No.	Date	Description

Seal:

Key Plan:

Issued For:  
**75% CONSTRUCTION  
 DOCUMENTS  
 - NOT FOR CONSTRUCTION -**

Scale: 1" = 20'  
 Date: APRIL 2021  
 Drawn By: TY, SG  
 Reviewed By: CC  
 Approved By: CFR

W&S Project No.: ENG20-0145  
 W&S File No.:

Drawing Title:  
**PLANTING PLAN**

Sheet Number:  
**L152**



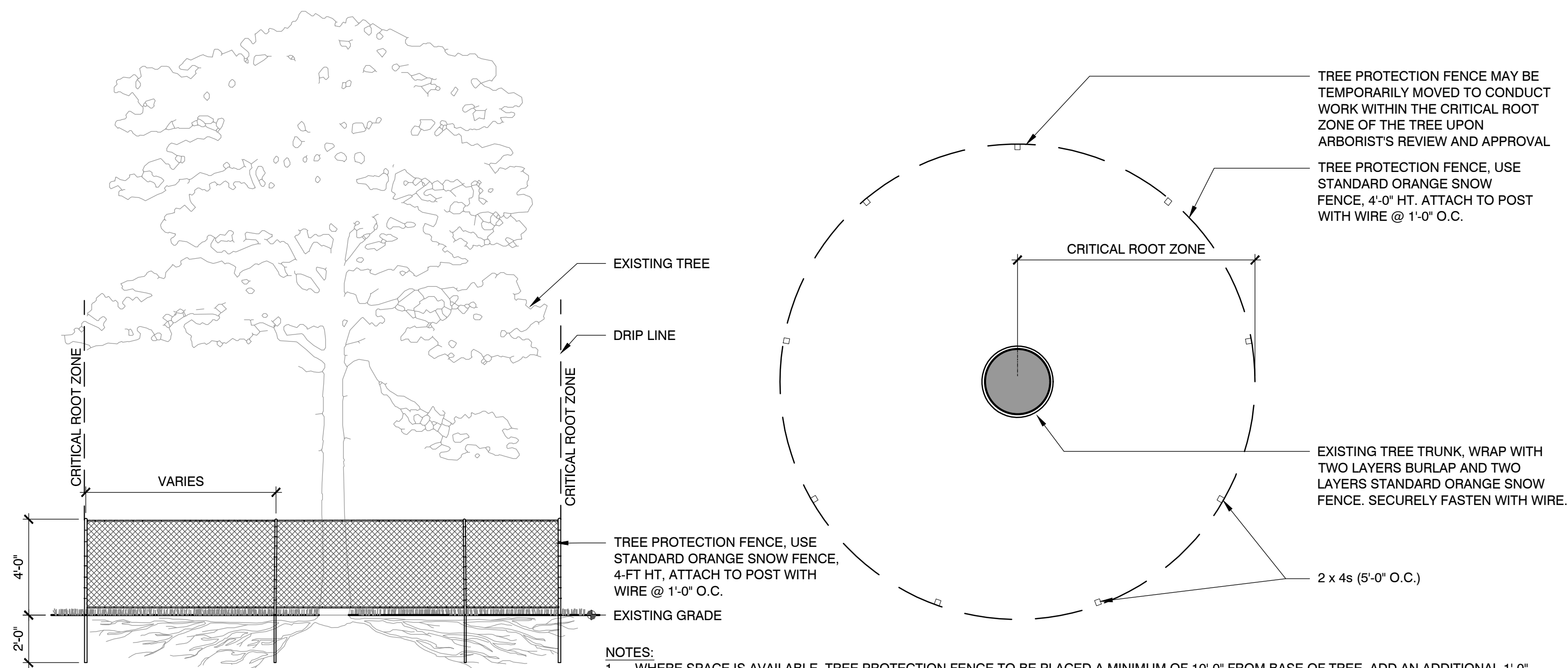

- NOTES:
1. WHERE SPACE IS AVAILABLE, TREE PROTECTION FENCE TO BE PLACED A MINIMUM OF 10'-0" FROM BASE OF TREE. ADD AN ADDITIONAL 1'-0" FOR EACH ADDITIONAL DBH INCH FOR TREES GREATER THAN 10" DBH (DIA. AT BREAST HT.).
  2. ALL WORK DONE WITHIN TREE PROTECTION FENCE IS TO BE DONE BY HAND AND WITH LIGHT EQUIPMENT.
  3. ROOTS EXPOSED DURING EXCAVATION SHALL BE NEATLY CUT AND COVERED WITH SOIL IMMEDIATELY.
  4. FOR TREES THAT OCCUR IN GROUPS, PROVIDE TREE PROTECTION FENCE AROUND ENTIRE AREA.
  5. MAINTAIN FENCE PROTECTION IN SOUND CONDITION UNTIL CONSTRUCTION COMPLETION.
  6. A CERTIFIED ARBORIST SHALL DELINEATE LIMIT OF TREE PROTECTION FENCE AS IT RELATES TO THE LIMITS OF THE CRITICAL ROOT ZONE.
  7. CRITICAL ROOT ZONE TO BE PROTECTED. ALL WORK NECESSARY WITHIN THE CRITICAL ROOT ZONE SHALL BE PERFORMED BY HAND.

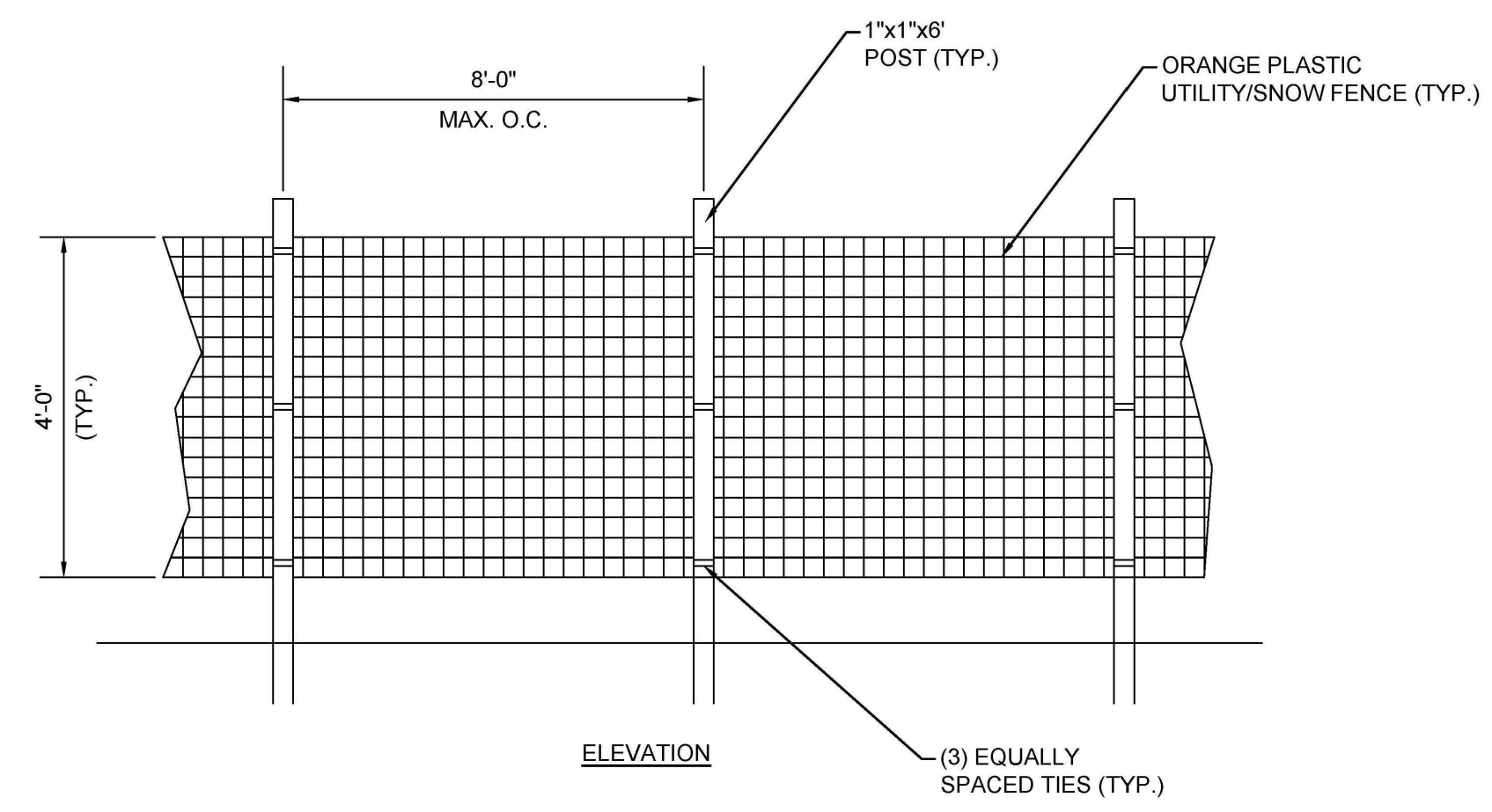

**2** TEMPORARY CONSTRUCTION FENCE  
SCALE: N.T.S.

**1** TREE PROTECTION  
SCALE: N.T.S.

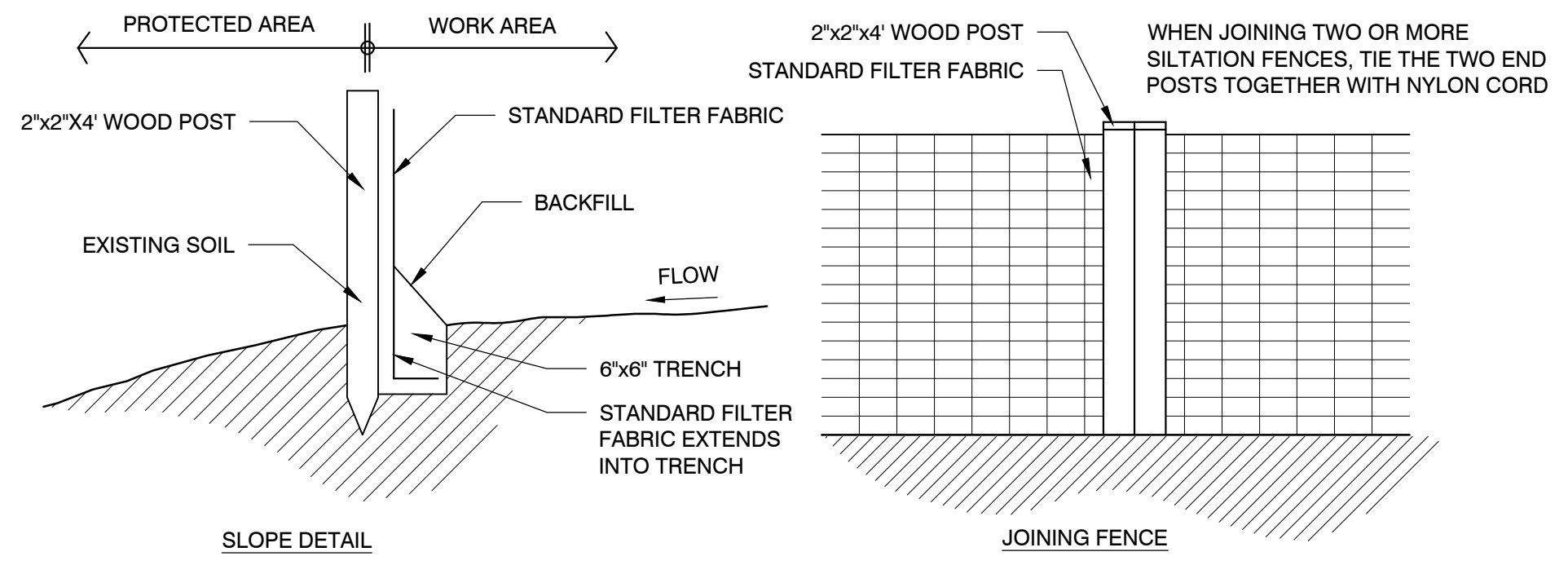
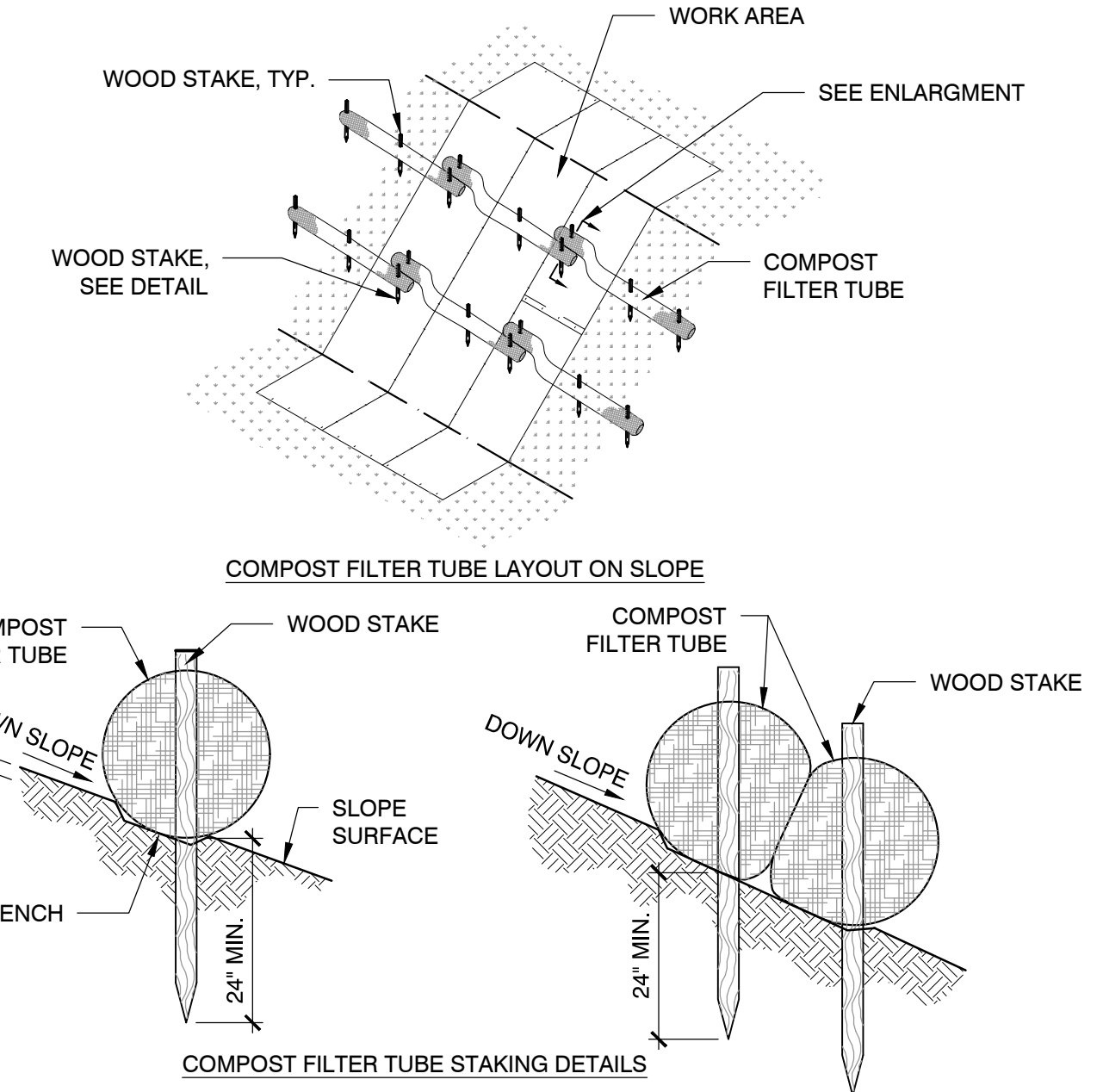

**3** EROSION CONTROL - COMPOST FILTER TUBE  
SCALE: N.T.S.

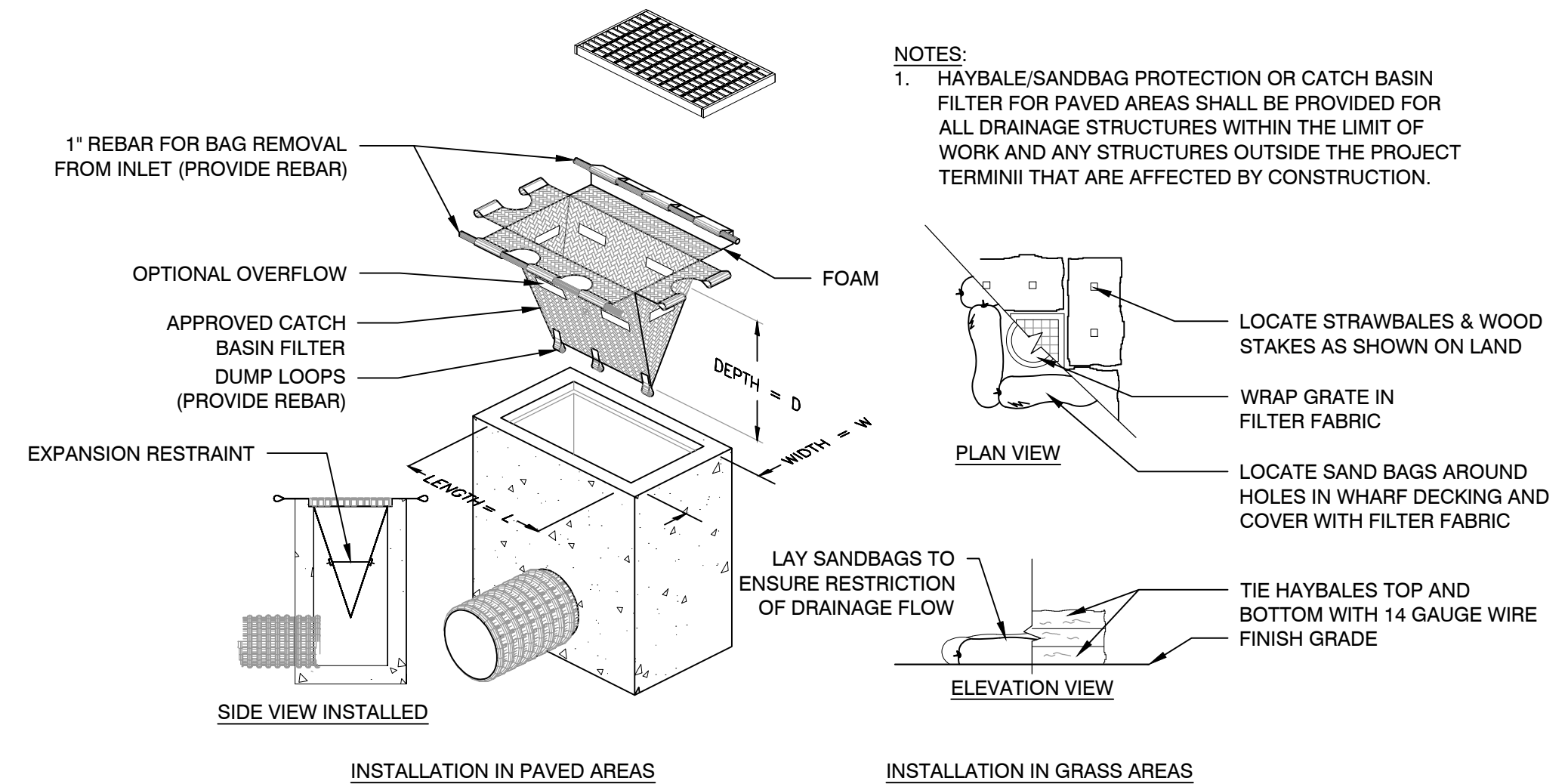

**4** INLET SEDIMENT CONTROL  
SCALE: N.T.S.

Project:  
PEABODY RIVERWALK  
RIVERWALK PARK

WALLIS STREET -  
CALLER STREET -  
HOWLEY STREET  
PEABODY, MA. 01960

Weston & Sampson  
WESTON & SAMPSON ENGINEERS, INC.  
85 DEVONSHIRE STREET, 3RD FLOOR  
BOSTON, MA 02109  
617-412-4480  
www.westonandsampson.com

Consultants:

Revisions:

No.	Date	Description

Seal:

Key Plan:

Issued For:

**75% CONSTRUCTION DOCUMENTS**  
**- NOT FOR CONSTRUCTION -**

Scale: N.T.S.

Date: APRIL 2021

Drawn By: FD, TY, SG

Reviewed By: CC

Approved By: CFR

W&S Project No.: ENG20-0145

W&S File No.:

Drawing Title:

**CONSTRUCTION DETAILS**

Sheet Number:

**L500**



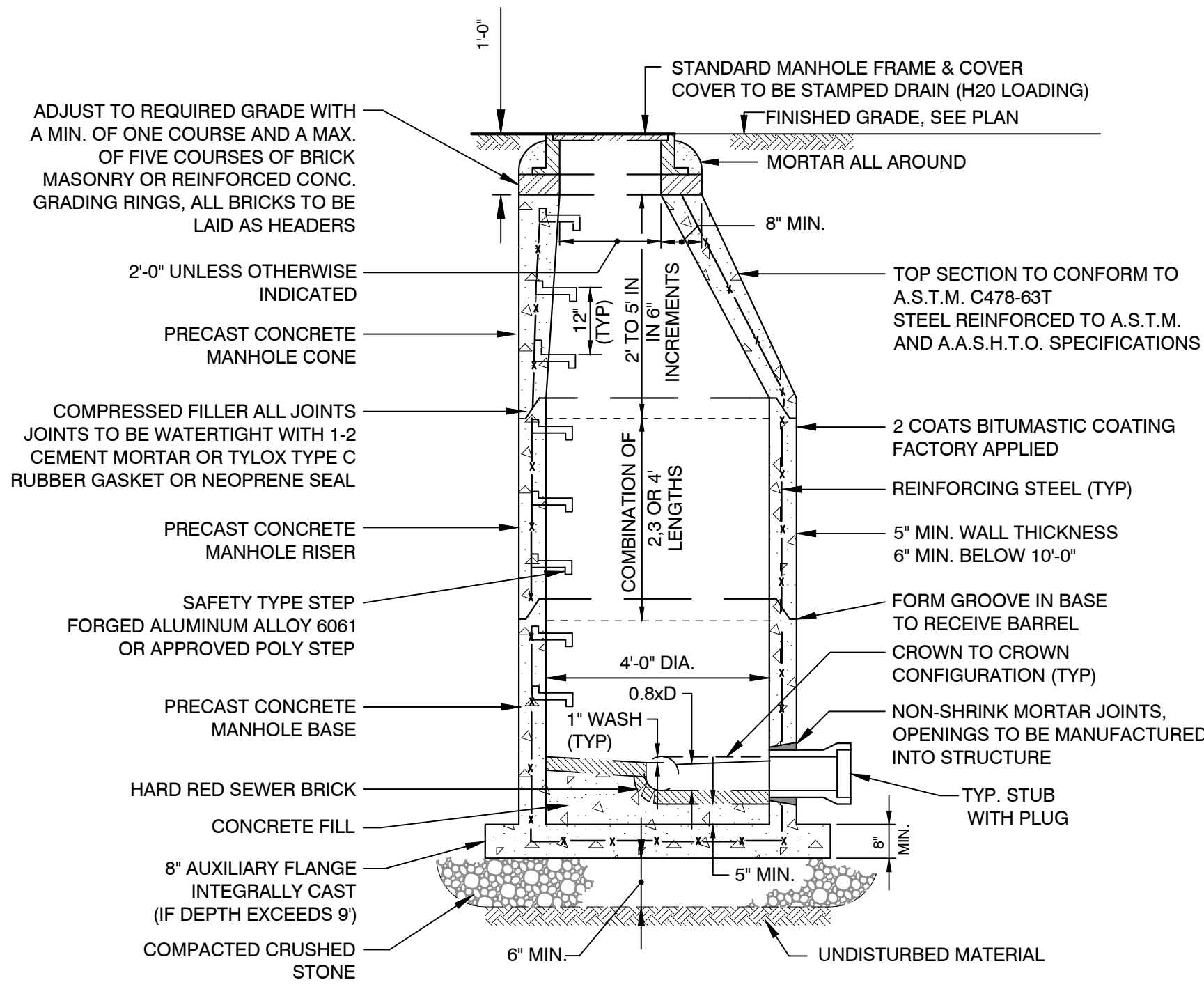

**1** DRAIN MANHOLE  
SCALE: N.T.S.

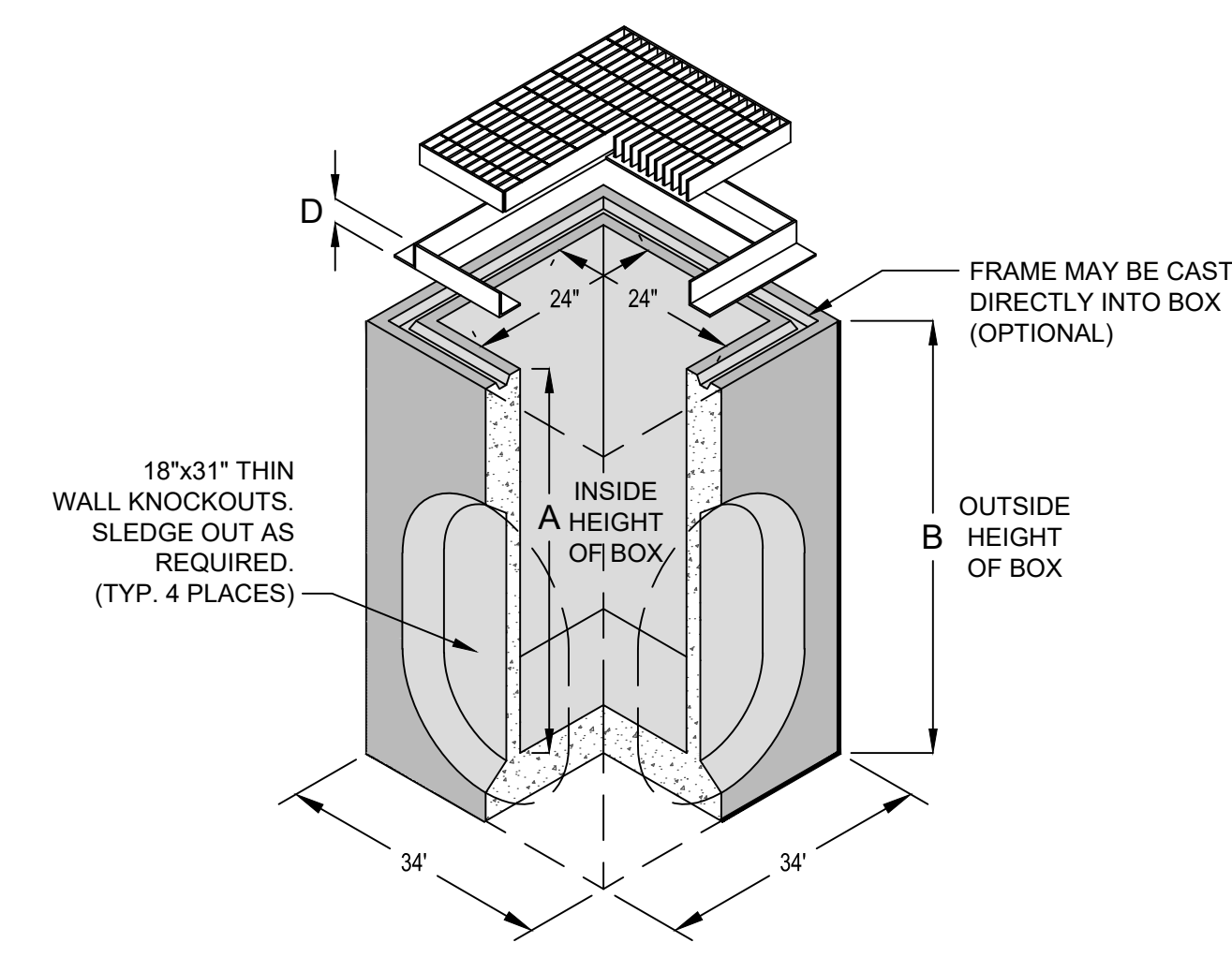

DROP INLET			
MODEL NO.	A	B	* WEIGHT
DI242436	36"	42"	1900 LBS.

\* BOX ONLY

FRAME AND GRATE			
MODEL NO.	RATING	D	WEIGHT
SG2424-DIT	TRAFFIC	3"	120 LBS.

**2** DROP INLET  
SCALE: N.T.S.

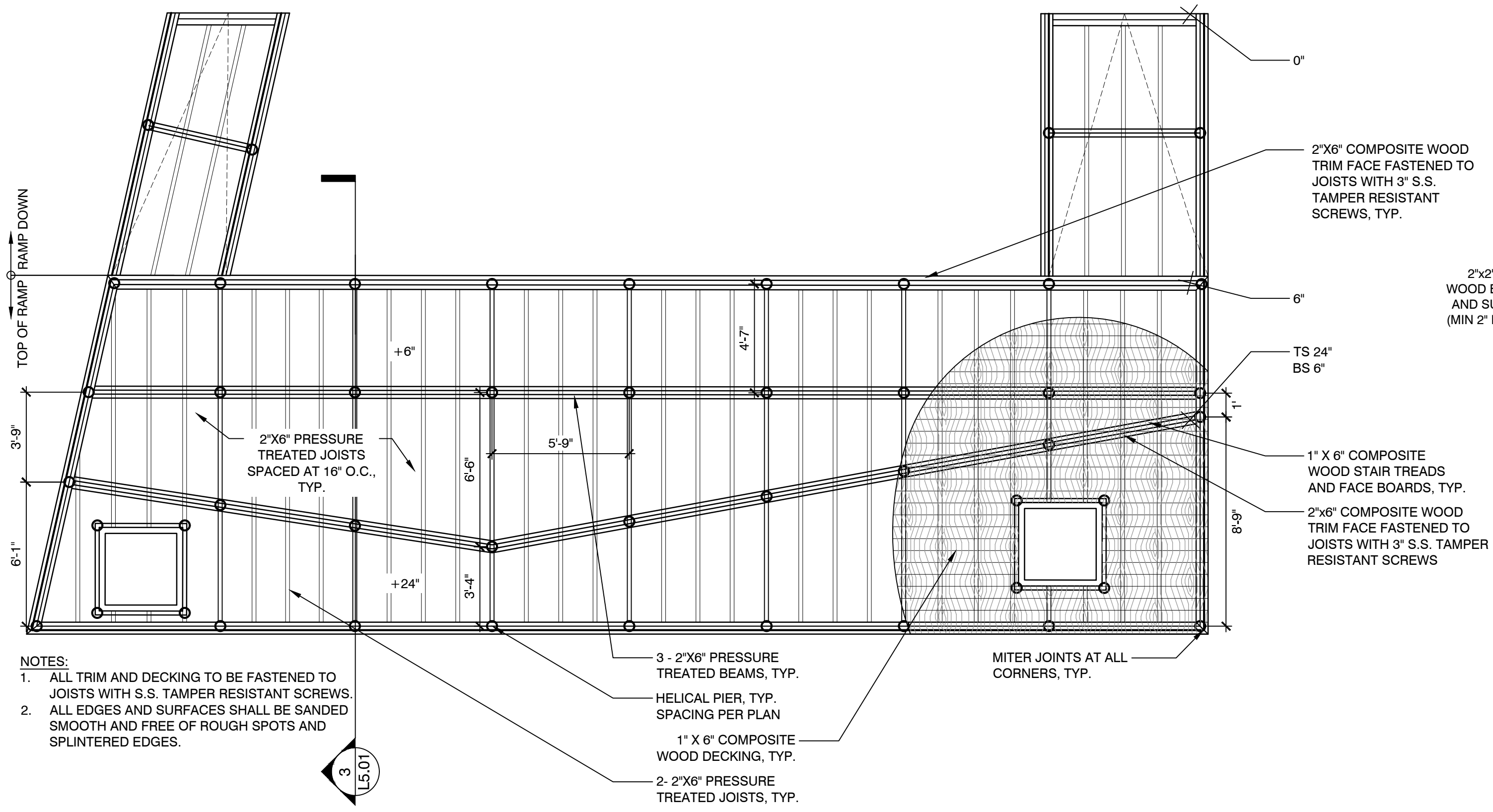

- NOTES:
- ALL TRIM AND DECKING TO BE FASTENED TO JOISTS WITH S.S. TAMPER RESISTANT SCREWS.
  - ALL EDGES AND SURFACES SHALL BE SANDED SMOOTH AND FREE OF ROUGH SPOTS AND SPLINTERED EDGES.

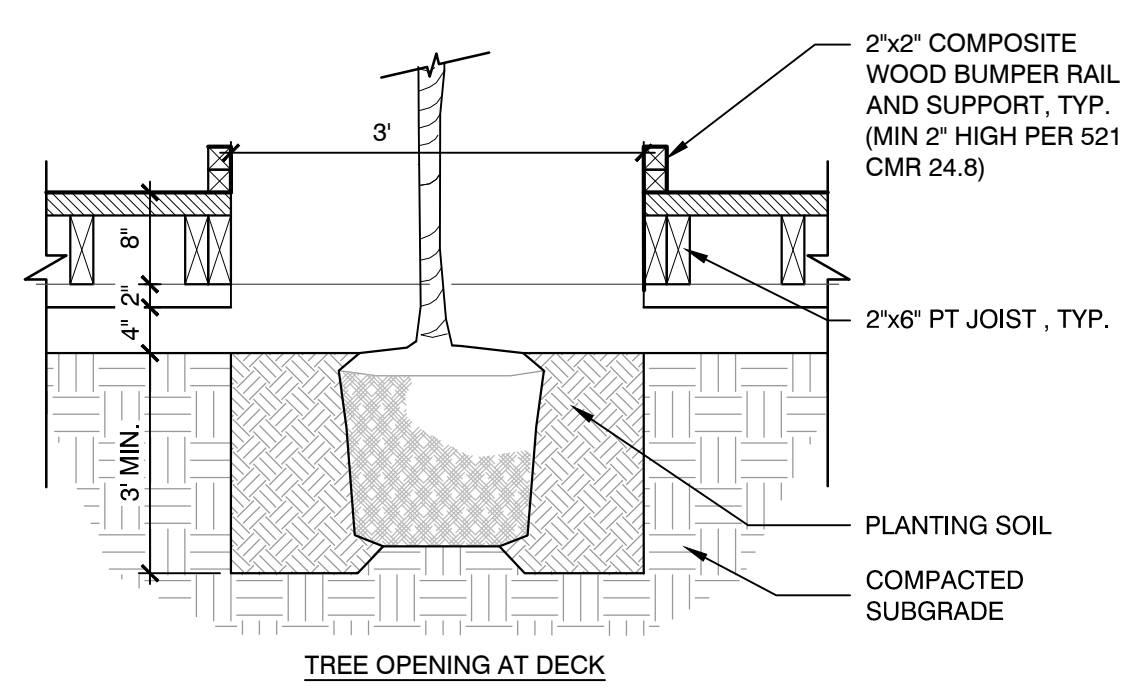
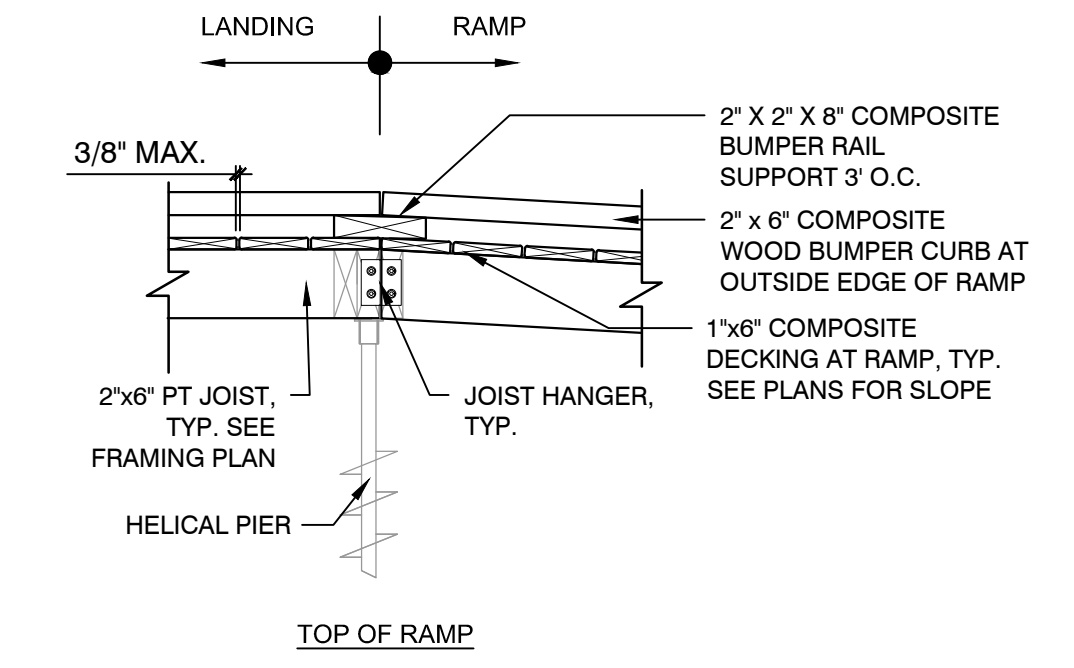
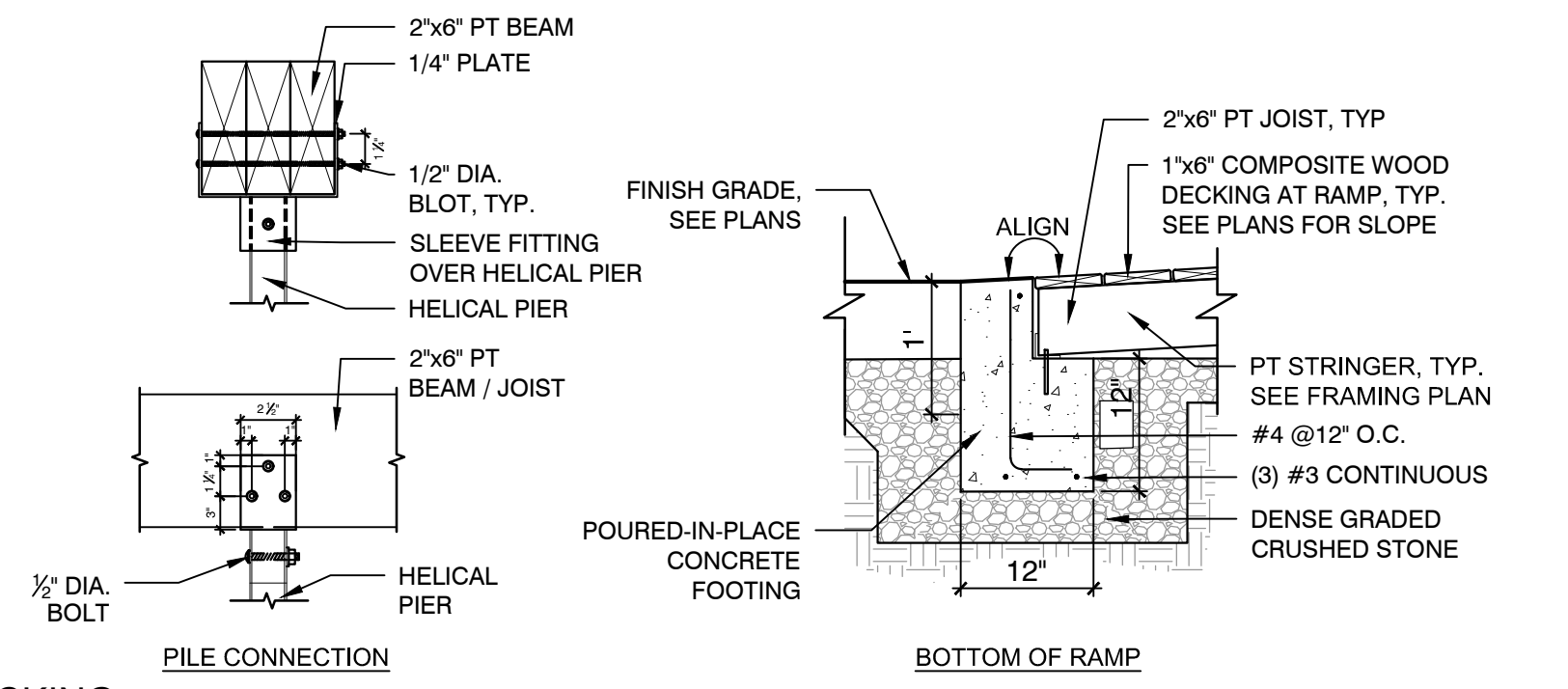
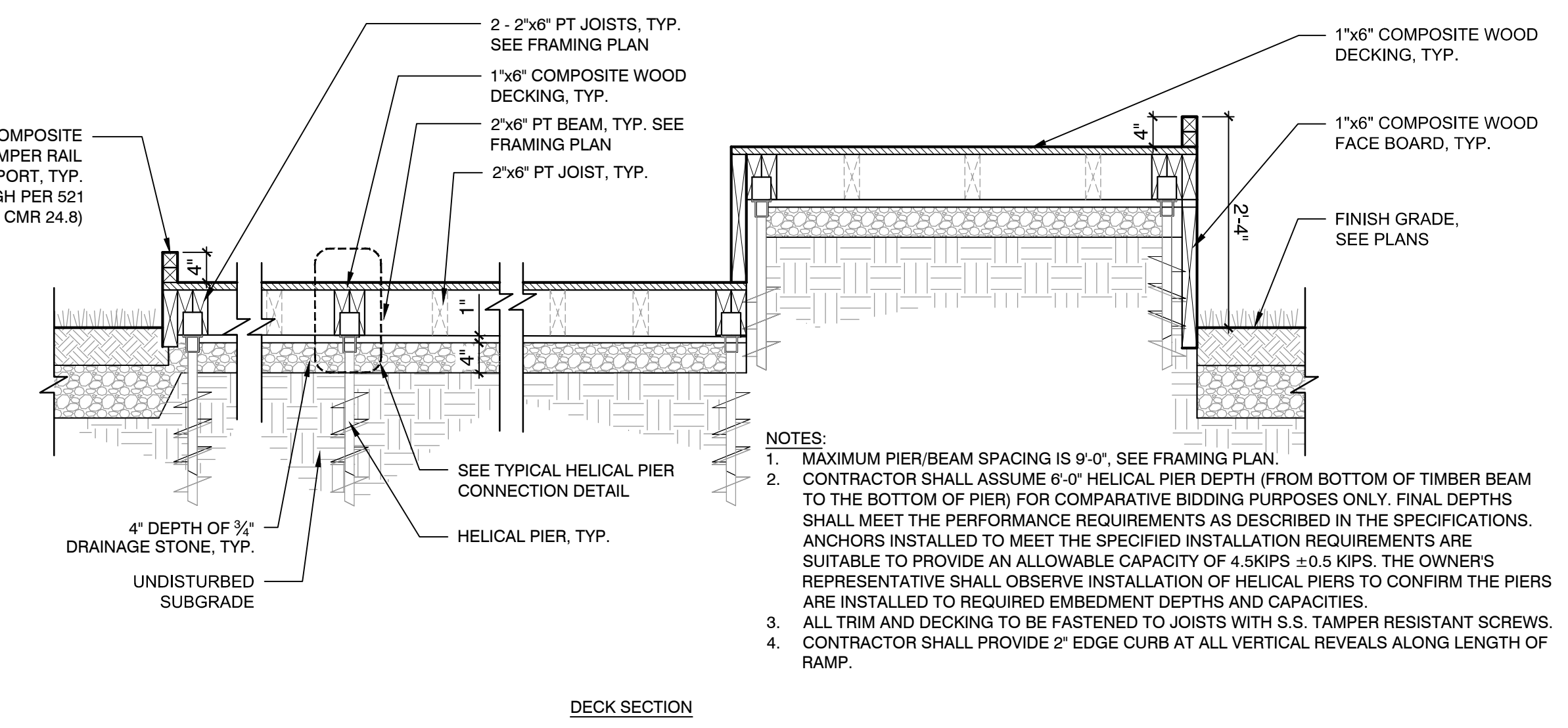

**3** WOOD DECKING  
SCALE: N.T.S.

Consultants:

Revisions:

No.	Date	Description

Seal:

Key Plan:

Issued For:  
**75% CONSTRUCTION DOCUMENTS**  
- NOT FOR CONSTRUCTION -

Scale: N.T.S.

Date: APRIL 2021

Drawn By: FD, TY, SG

Reviewed By: CC

Approved By: CFR

W&S Project No.: ENG20-0145

W&S File No.:

Drawing Title:  
**CONSTRUCTION DETAILS**

Sheet Number:  
**L501**



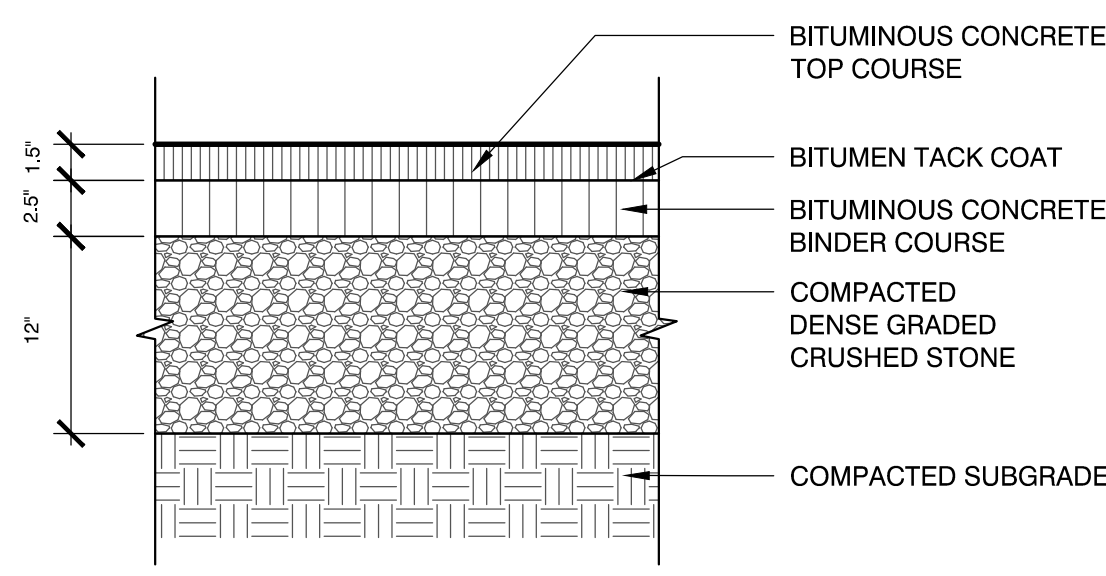

NOTES:  
1. CONTRACTOR TO PROVIDE SMOOTH TRANSITION WHERE NEW PAVEMENT ABUTS EXISTING PAVEMENT, TYP.

**1** VEHICULAR BITUMINOUS CONCRETE PAVEMENT  
SCALE: N.T.S.

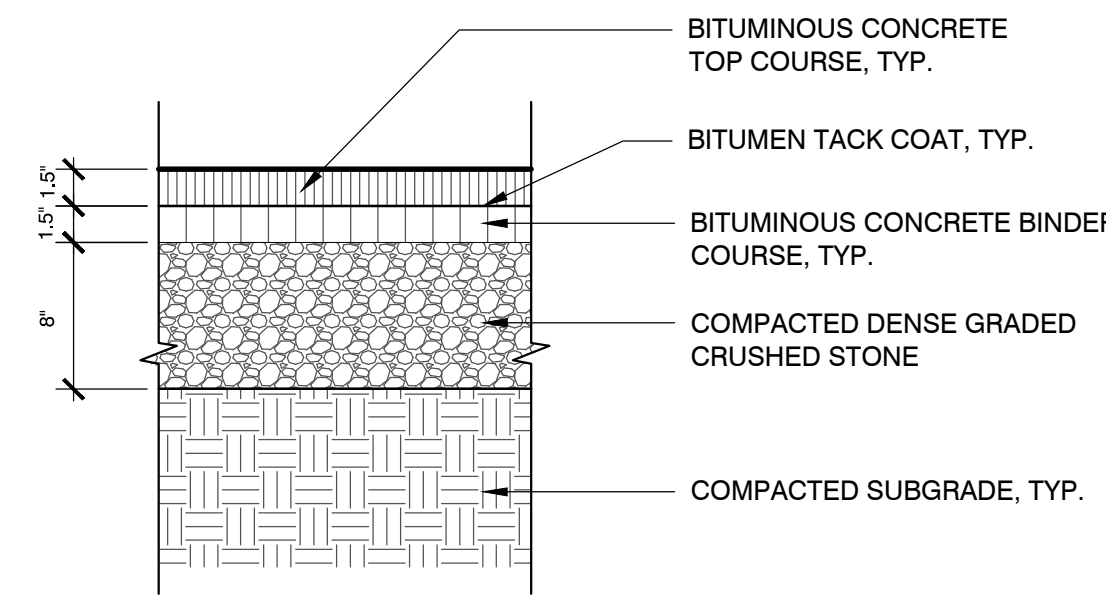

NOTE:  
1. CONTRACTOR TO PROVIDE SMOOTH TRANSITION WHERE NEW PAVEMENT ABUTS EXISTING PAVEMENT, TYP.

**2** PEDESTRIAN BITUMINOUS CONCRETE PAVEMENT  
SCALE: N.T.S.

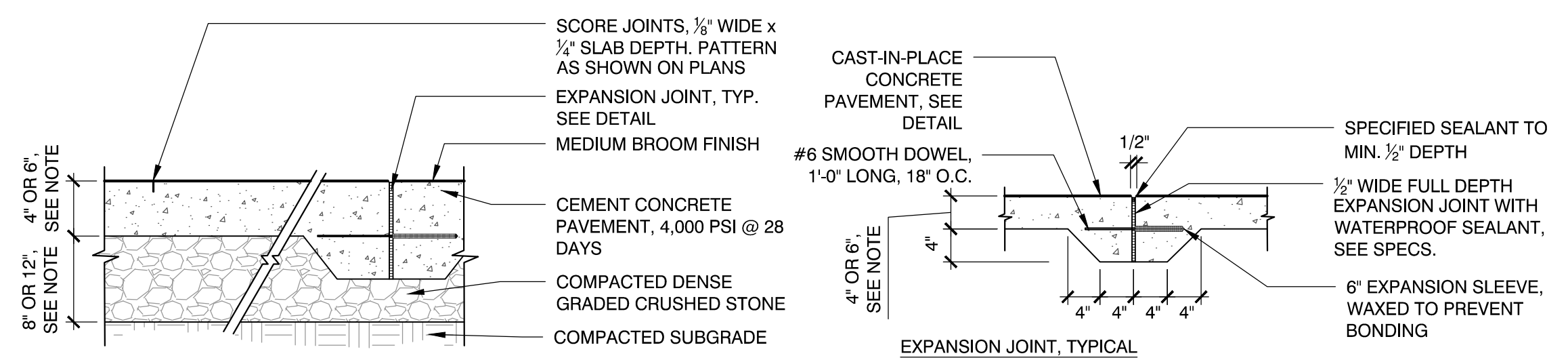

CAST-IN-PLACE CONCRETE PAVEMENT  
CAST-IN-PLACE CONCRETE NOTES:  
1. PEDESTRIAN CAST-IN-PLACE CONCRETE PAVEMENT TO BE 4\"/>

EXPANSION JOINT, TYPICAL  
EXPANSION JOINT INSTALLATION NOTES:  
1. DOWEL IS TYPICAL AT ALL EXPANSION JOINTS (18\"/>

**3** CIP CONCRETE PAVEMENT  
SCALE: N.T.S.

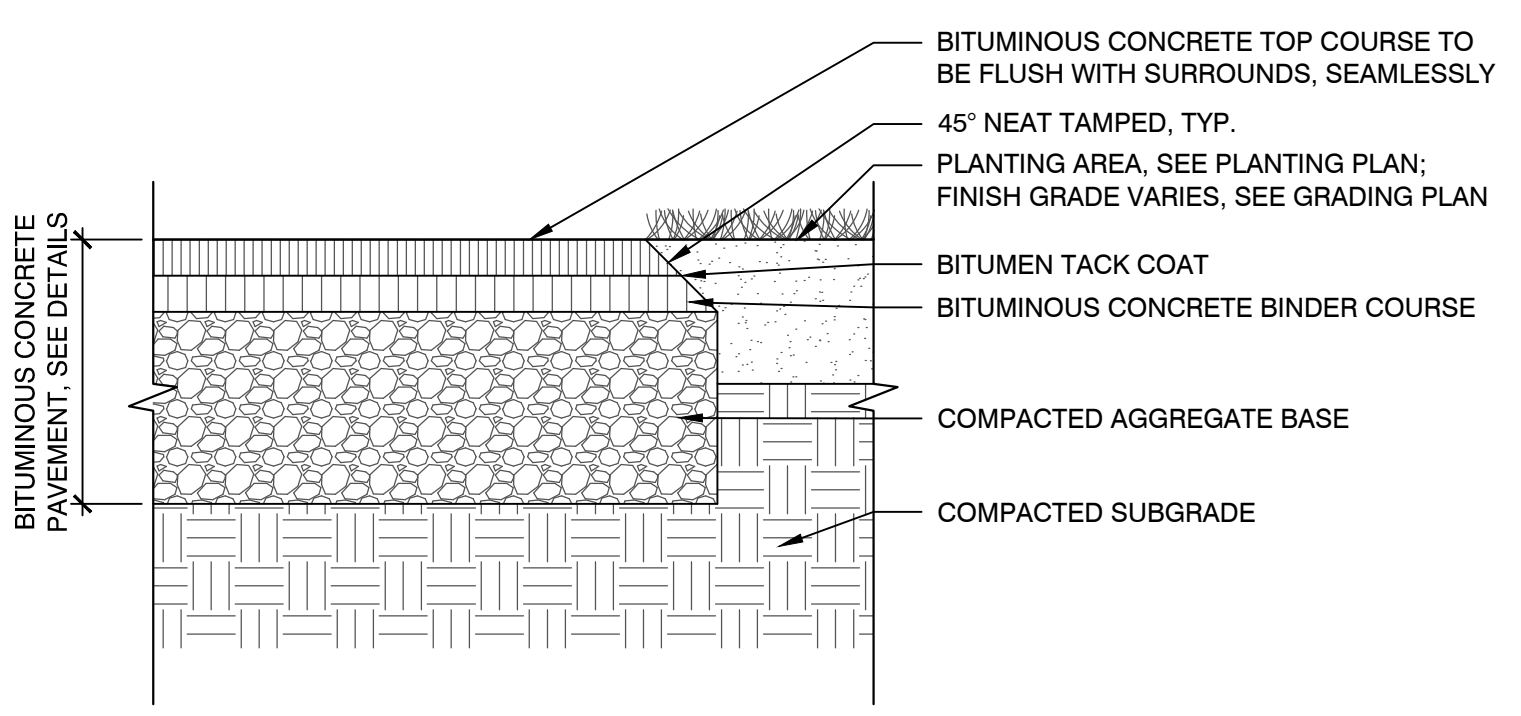

**4** BITUMINOUS CONCRETE AT PLANTING  
SCALE: N.T.S.

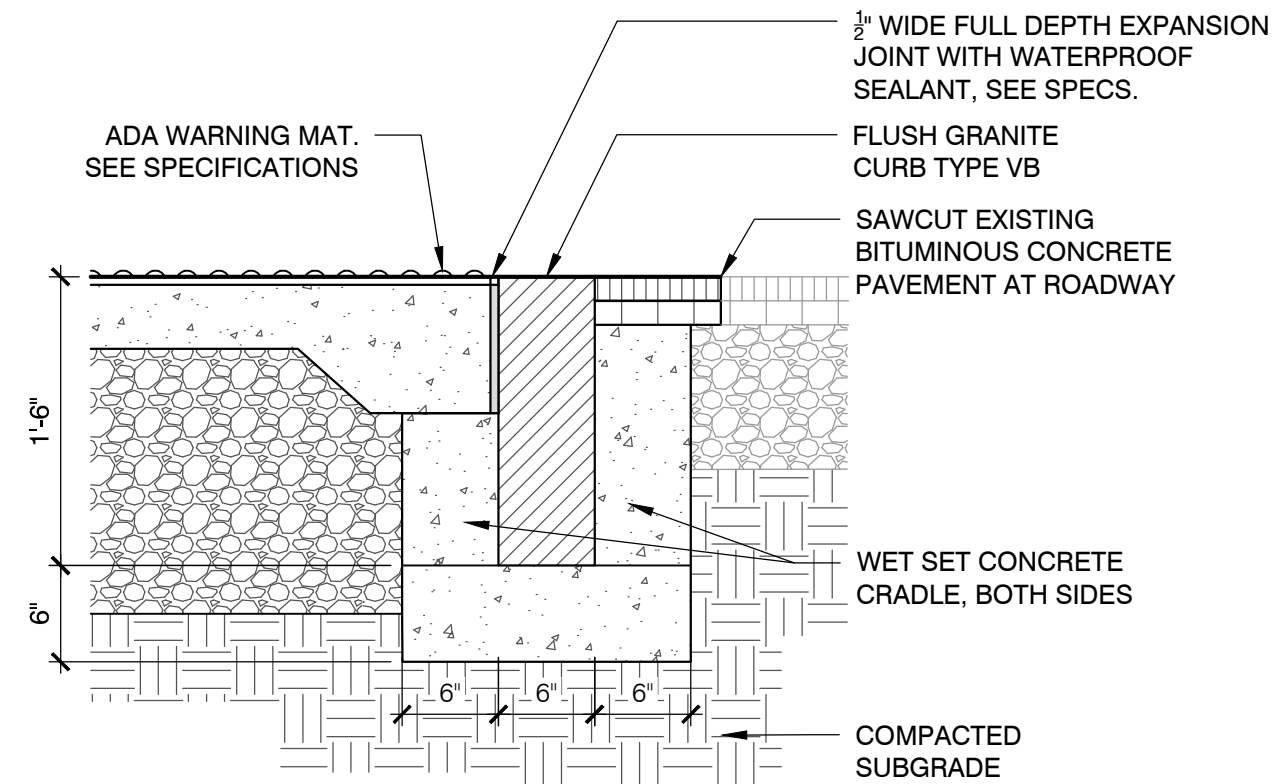

**5** FLUSH GRANITE CURB WITH ADA DETECTABLE WARNING MAT  
SCALE: N.T.S.

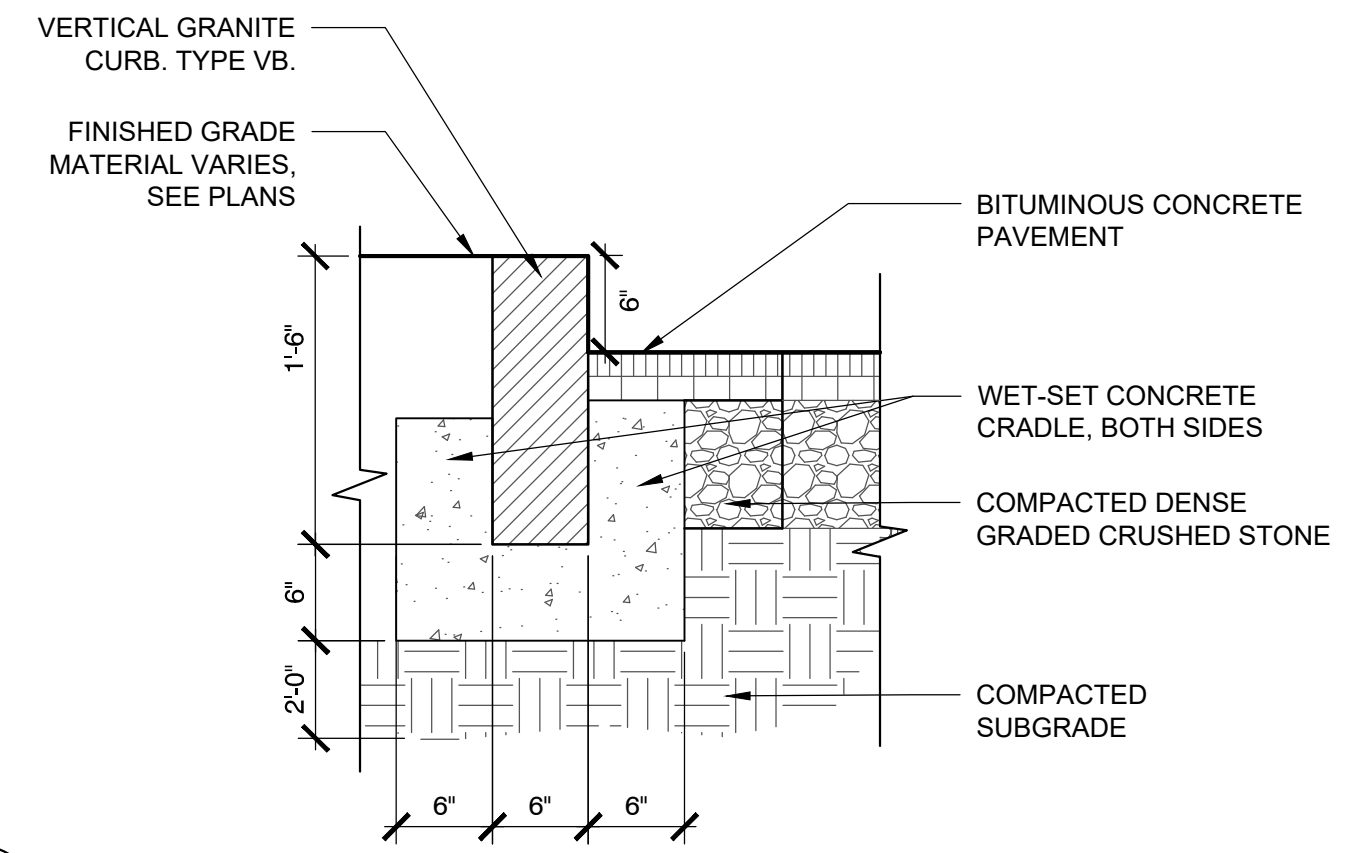

**6** VERTICAL GRANITE CURB  
SCALE: N.T.S.

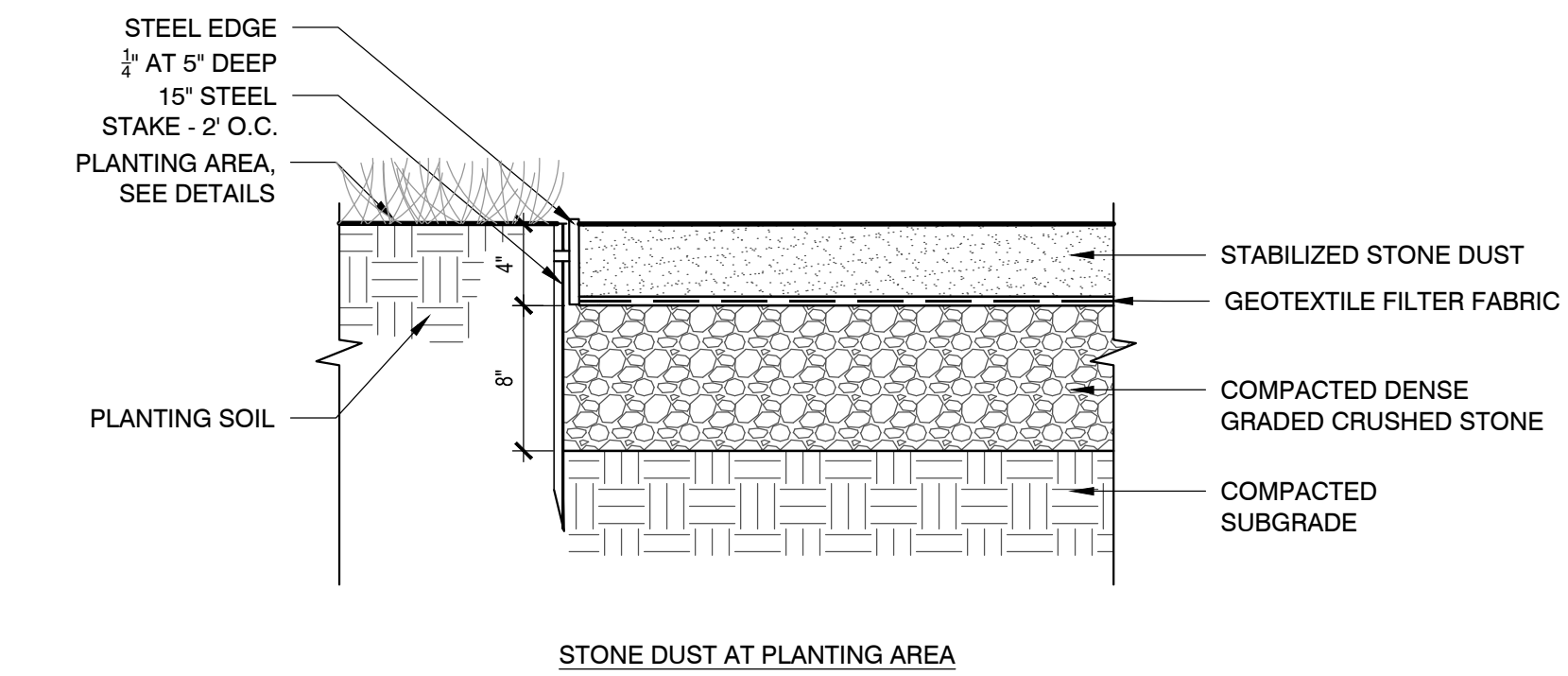

**7** STONE DUST PAVING WITH STEEL EDGE  
SCALE: N.T.S.

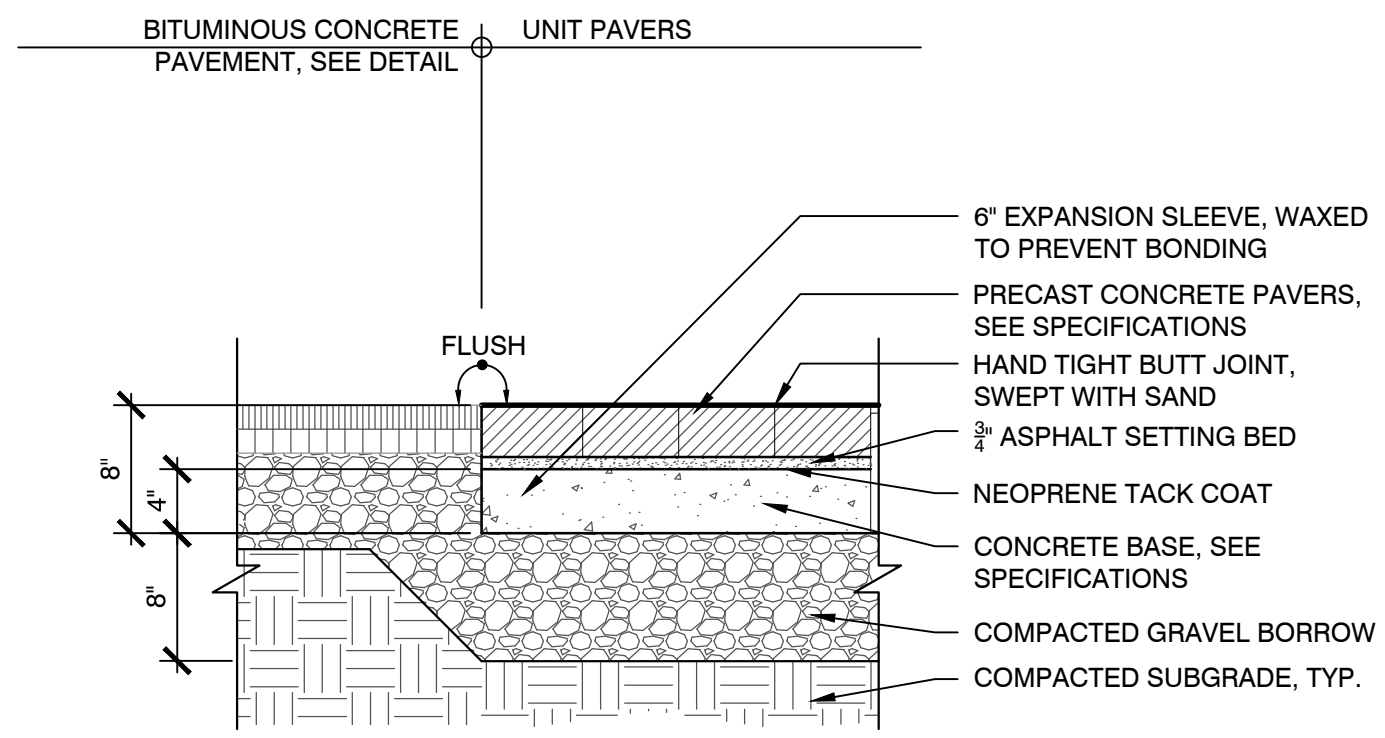

**8** UNIT PAVERS AT BITUMINOUS CONCRETE PAVEMENT  
SCALE: N.T.S.

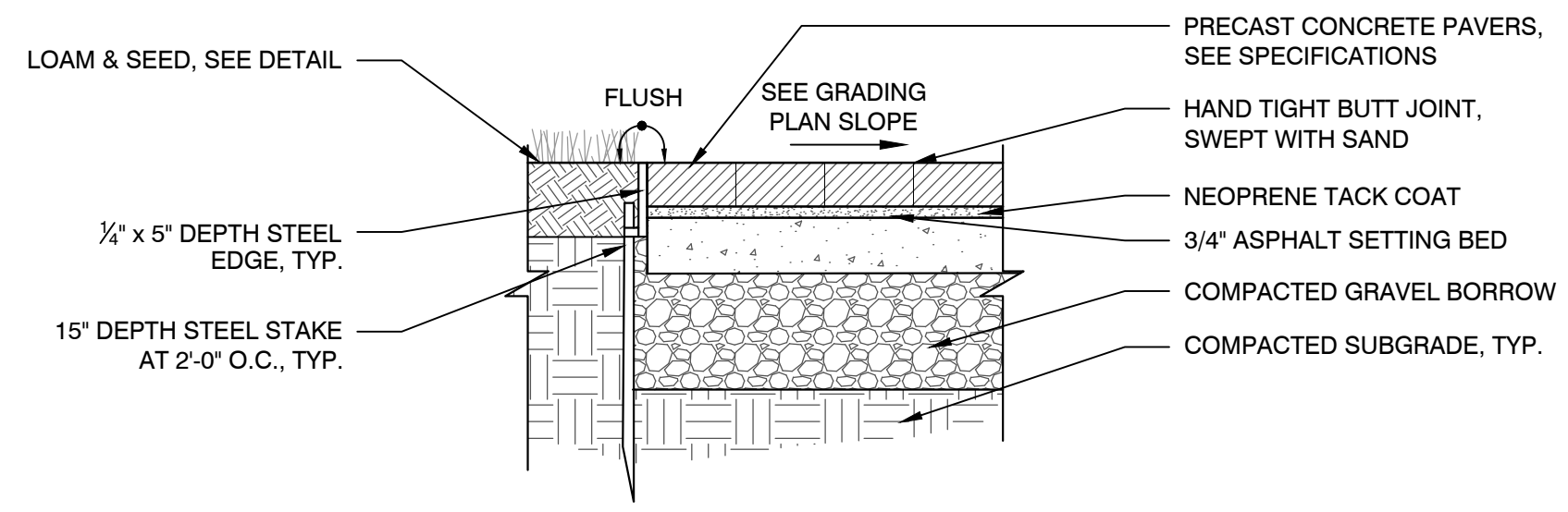

**9** UNIT PAVERS AT PLANTING AREA  
SCALE: N.T.S.

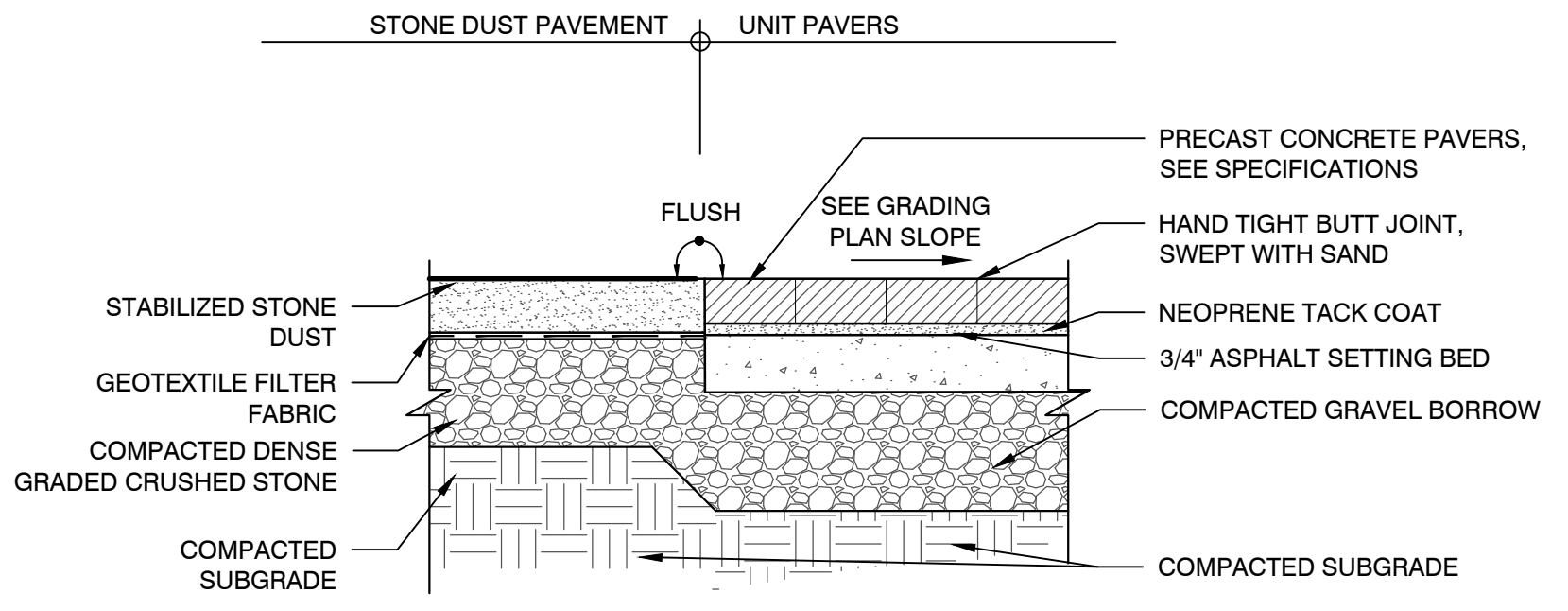

**10** UNIT PAVERS AT STONE DUST  
SCALE: N.T.S.

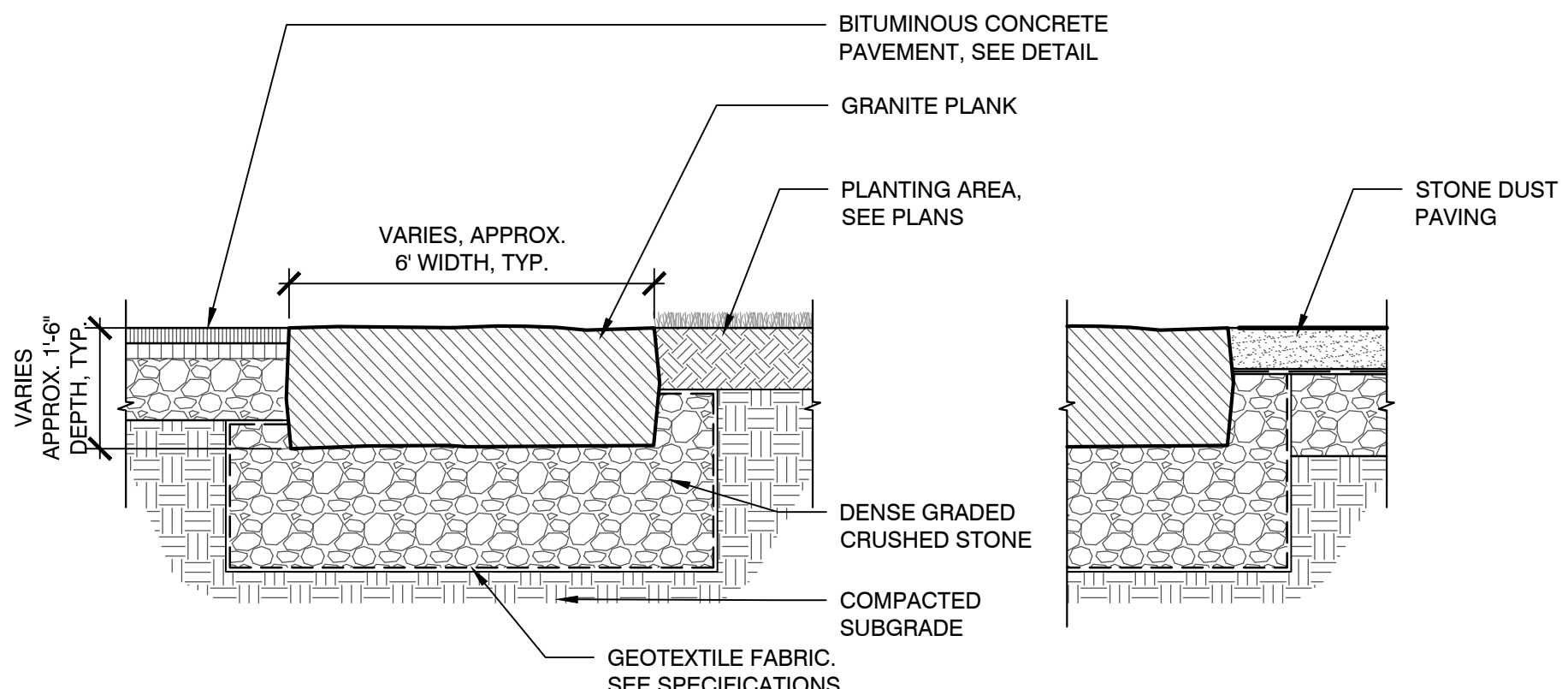

**11** ENGRAVED GRANITE PLANKS  
SCALE: N.T.S.

Project:  
PEABODY RIVERWALK  
RIVERWALK PARK

WALLIS STREET -  
CALLER STREET -  
HOWLEY STREET  
PEABODY, MA. 01960

Weston & Sampson  
WESTON & SAMPSON ENGINEERS, INC.  
85 DEVONSHIRE STREET, 3RD FLOOR  
BOSTON, MA 02109  
617-412-4480  
www.westonandsampson.com

Consultants:

Revisions:

No.	Date	Description

Seal:

Key Plan:

Issued For:

75% CONSTRUCTION DOCUMENTS  
- NOT FOR CONSTRUCTION -

Scale: N.T.S.  
Date: APRIL 2021  
Drawn By: FD, TY, SG  
Reviewed By: CC  
Approved By: CFR

W&S Project No.: ENG20-0145  
W&S File No.:

Drawing Title:

CONSTRUCTION DETAILS

Sheet Number:

**L502**

COPYRIGHT © 2020 WESTON & SAMPSON, INC.



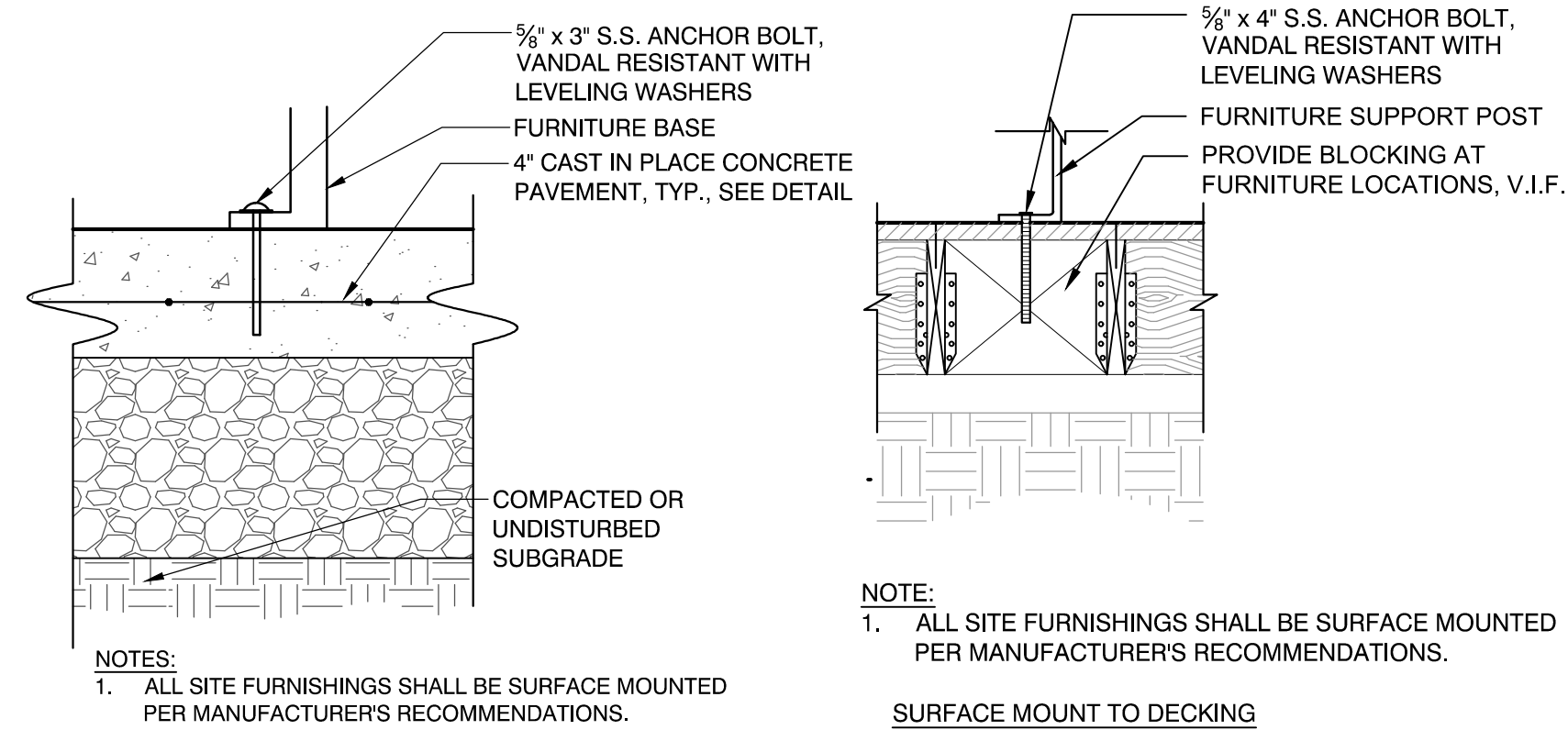

**1 FURNITURE SURFACE MOUNT**  
SCALE: N.T.S.

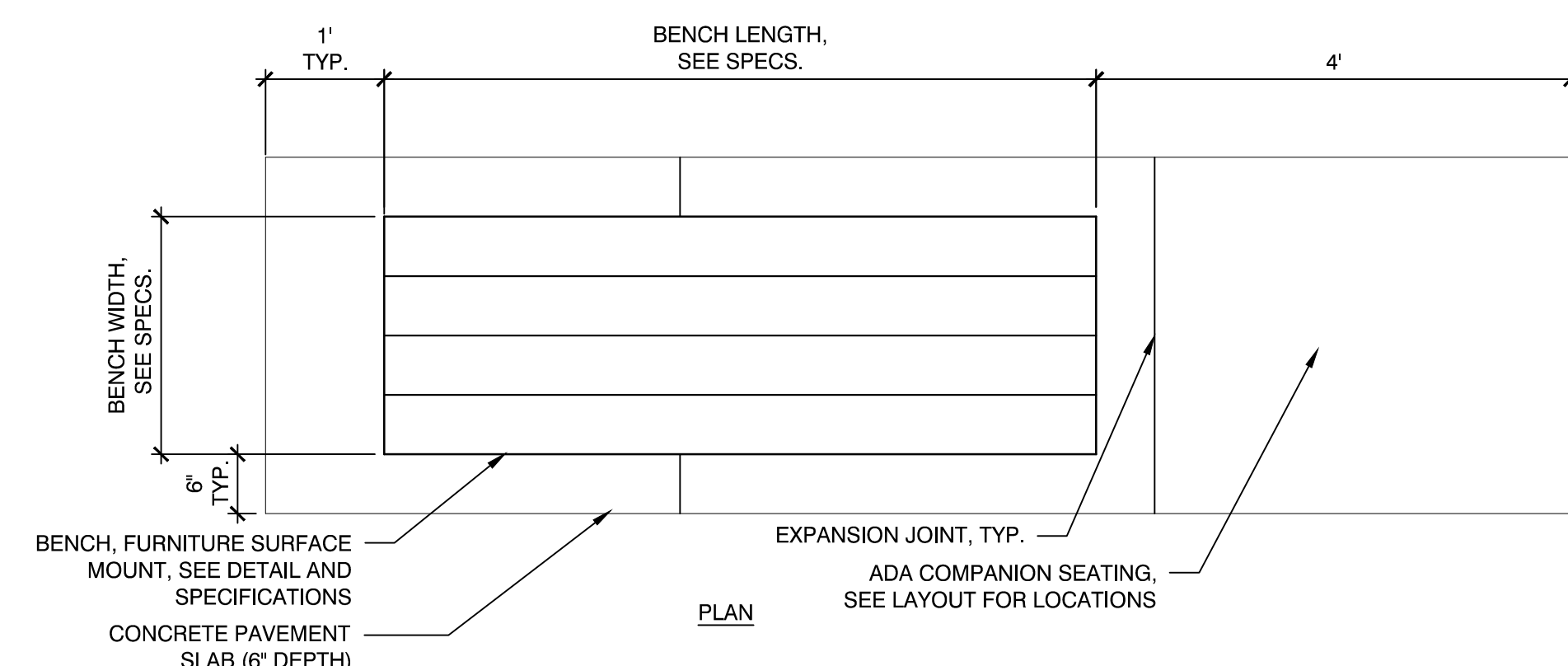

**2 BENCH ON CONCRETE PAD**  
SCALE: N.T.S.

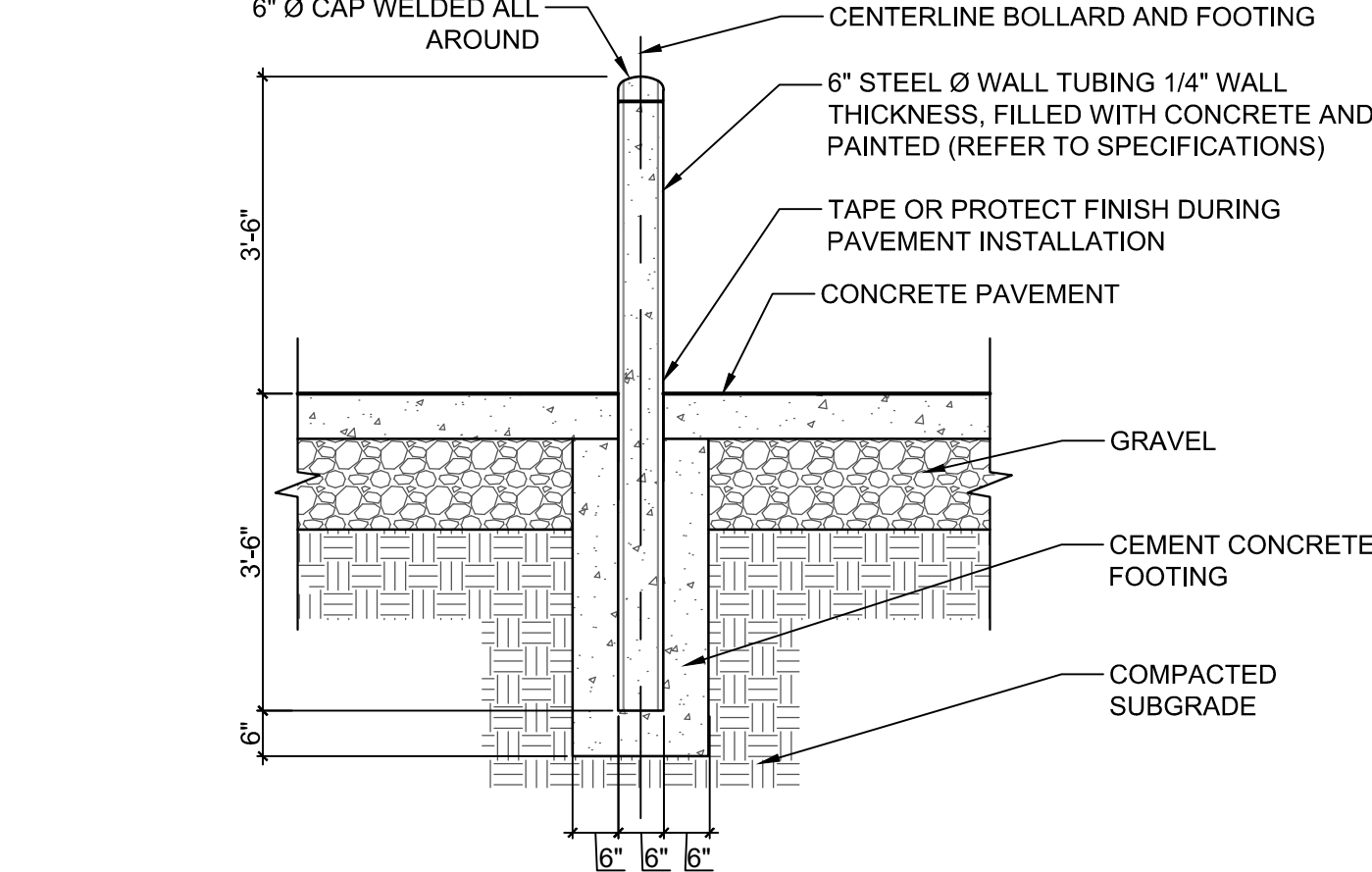

**3 VEHICLE BOLLARD**  
SCALE: N.T.S.

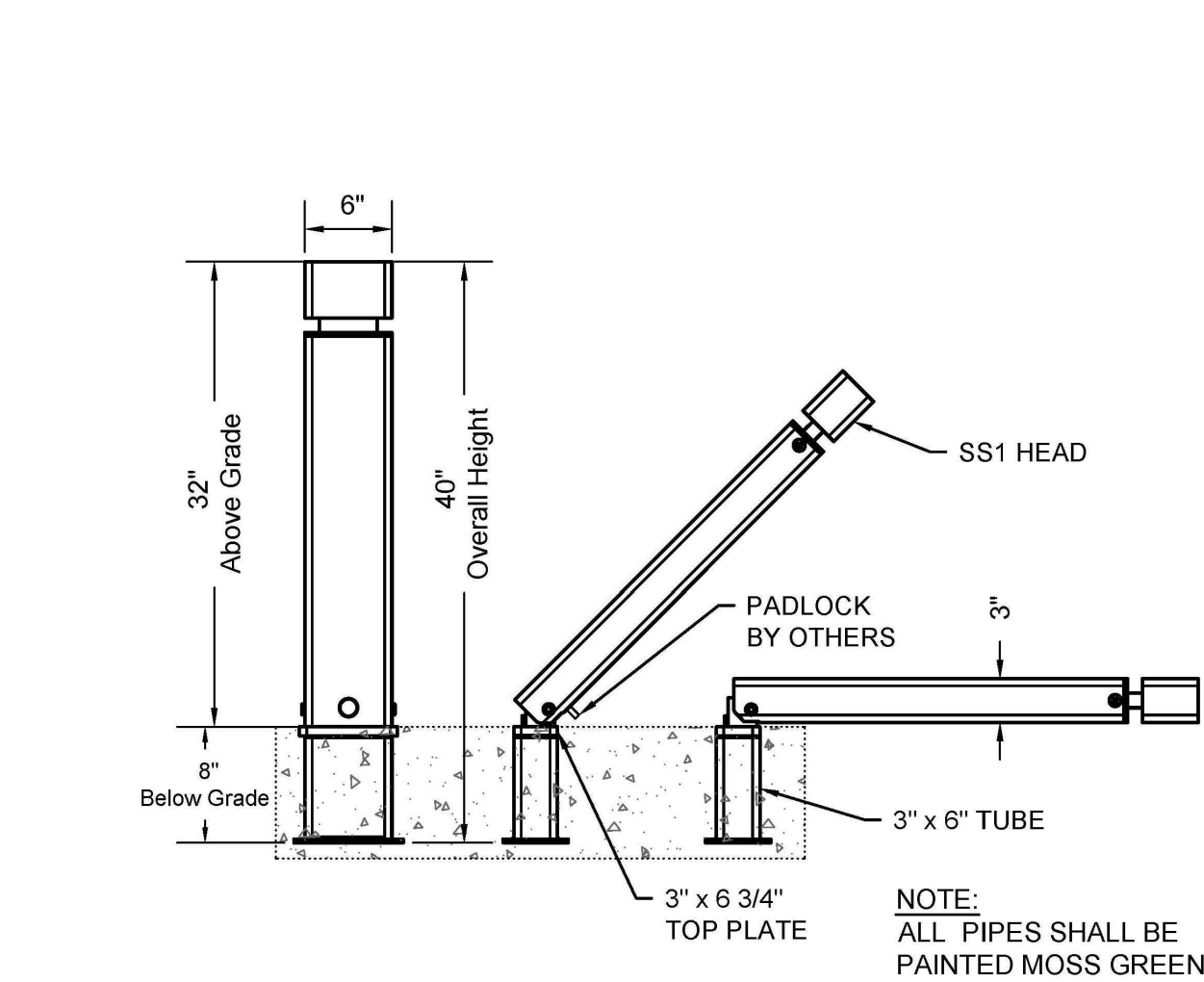

**4 COLLAPSIBLE BOLLARD**  
SCALE: N.T.S.

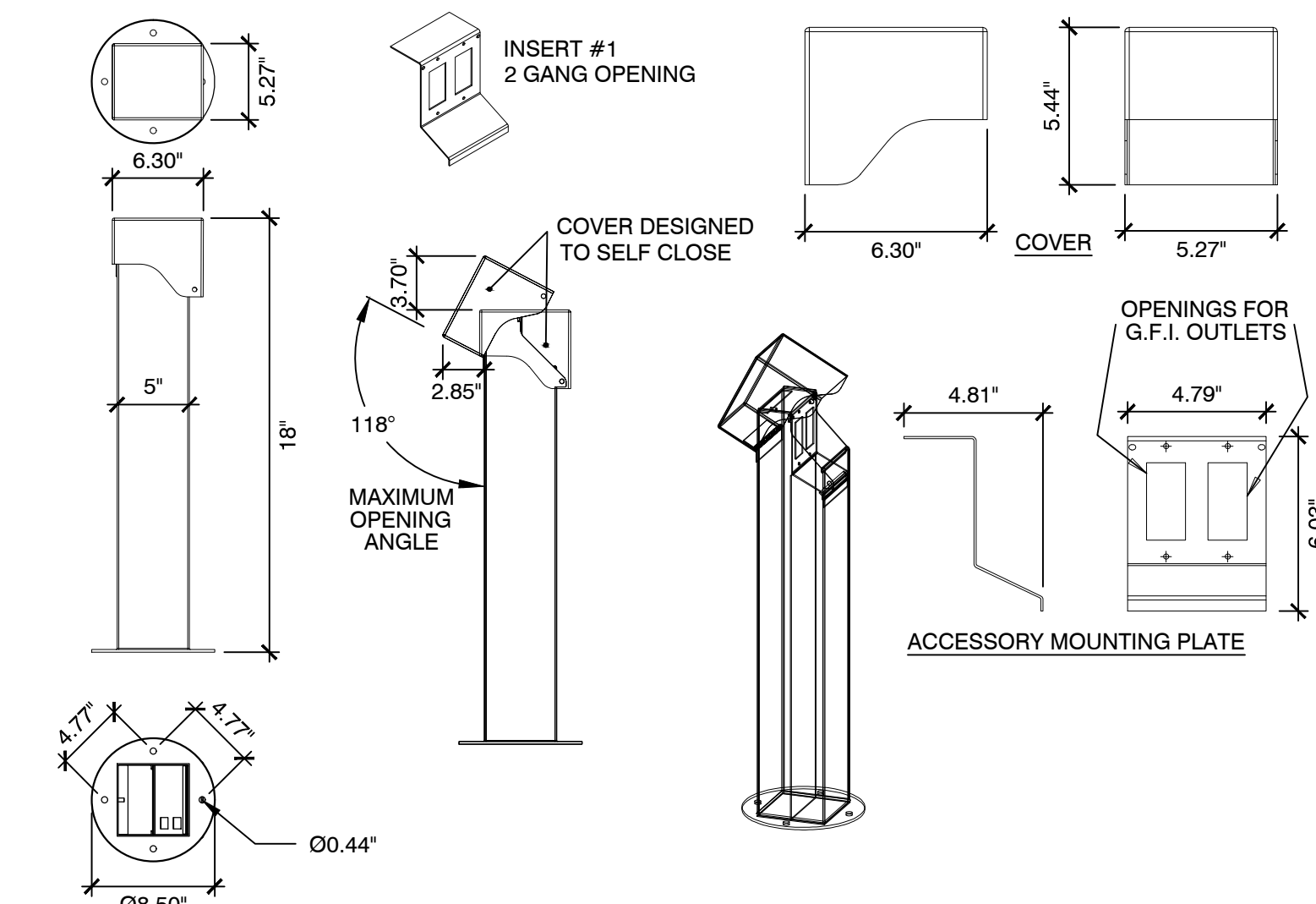

**5 UTILITY BOLLARD**  
SCALE: N.T.S.

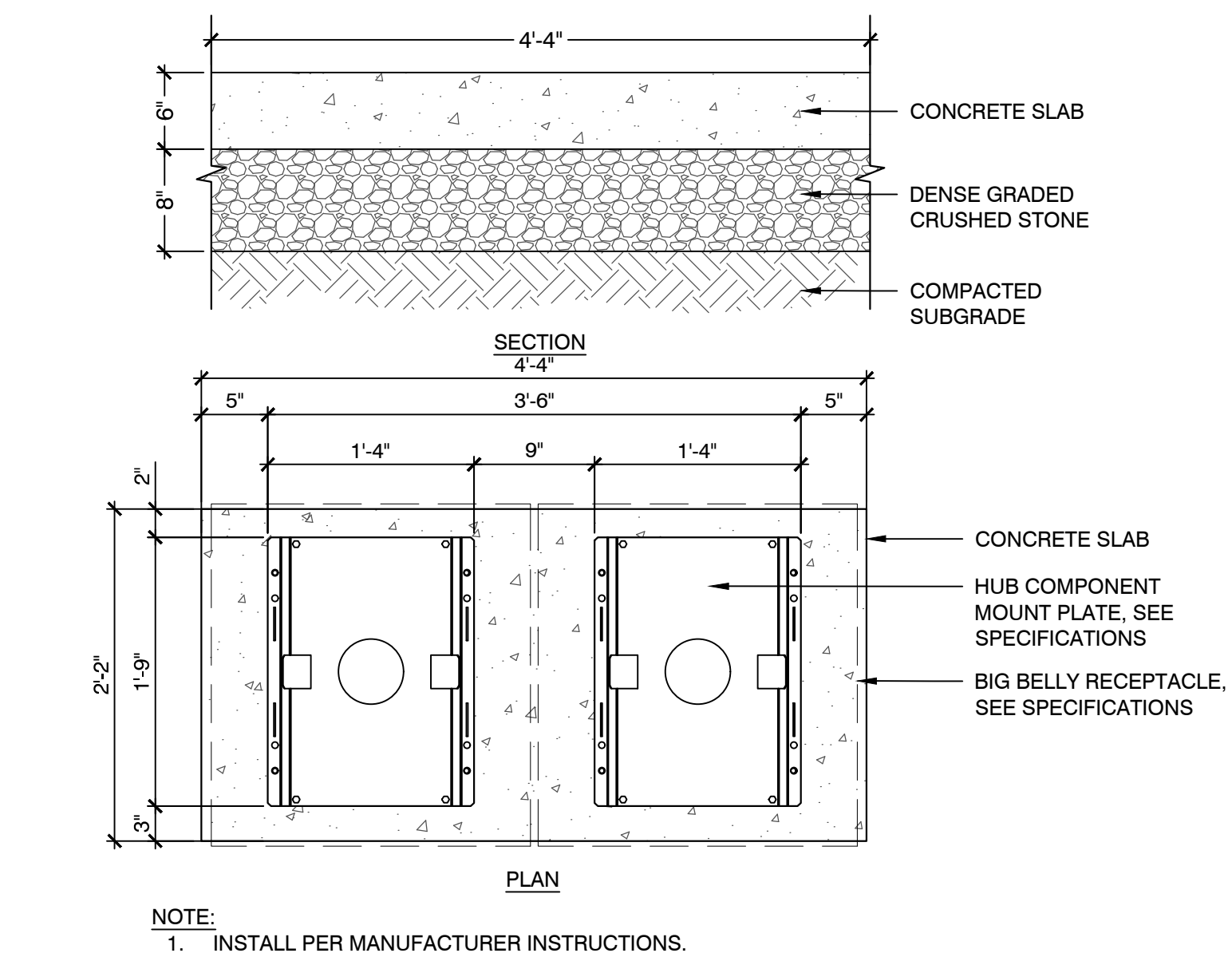

**6 TRASH AND RECYCLE RECEPTACLES ON CONCRETE SLAB**  
SCALE: N.T.S.

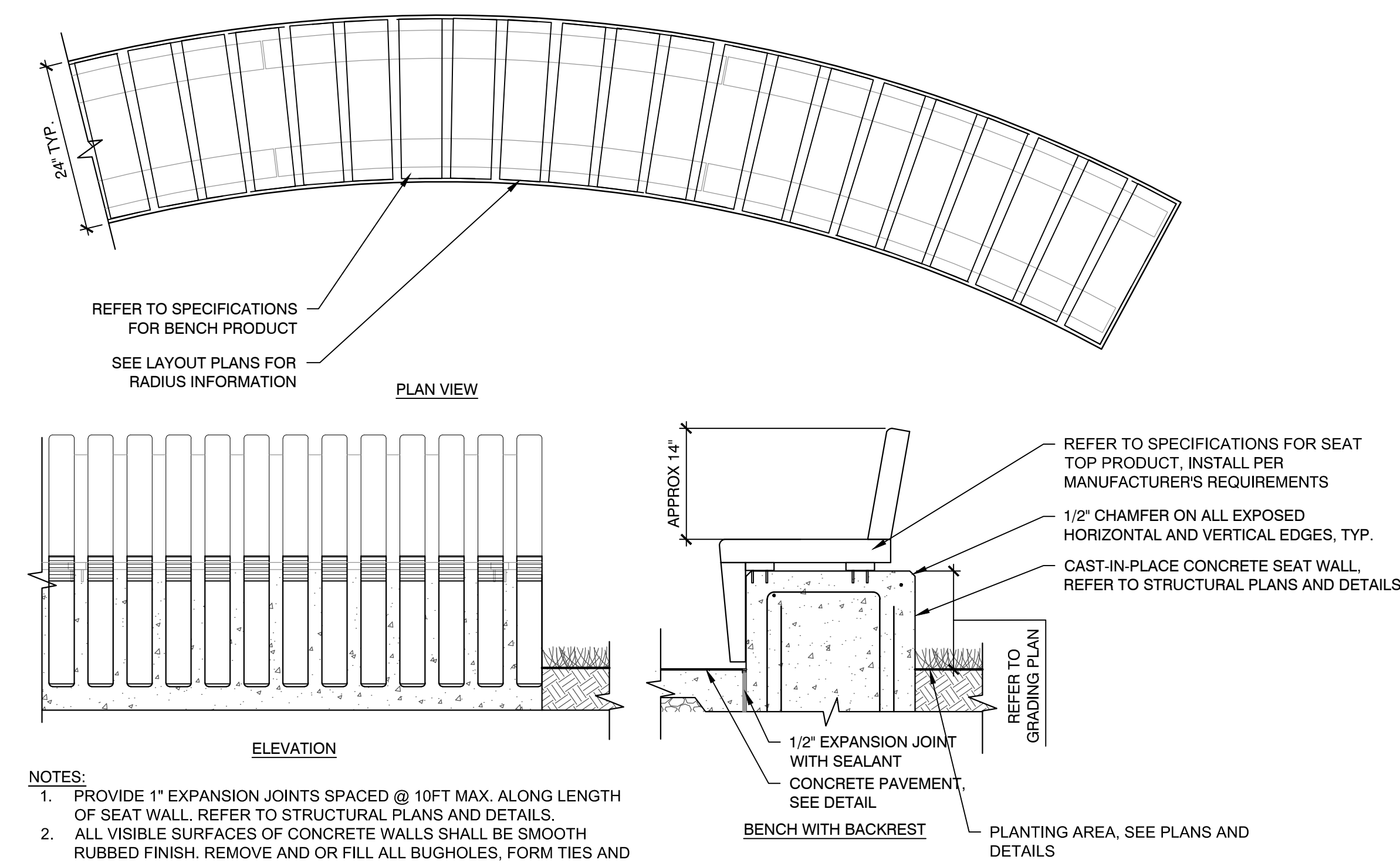

**7 CIP CONCRETE SEATWALL WITH WOOD SLAT TOP**  
SCALE: N.T.S.

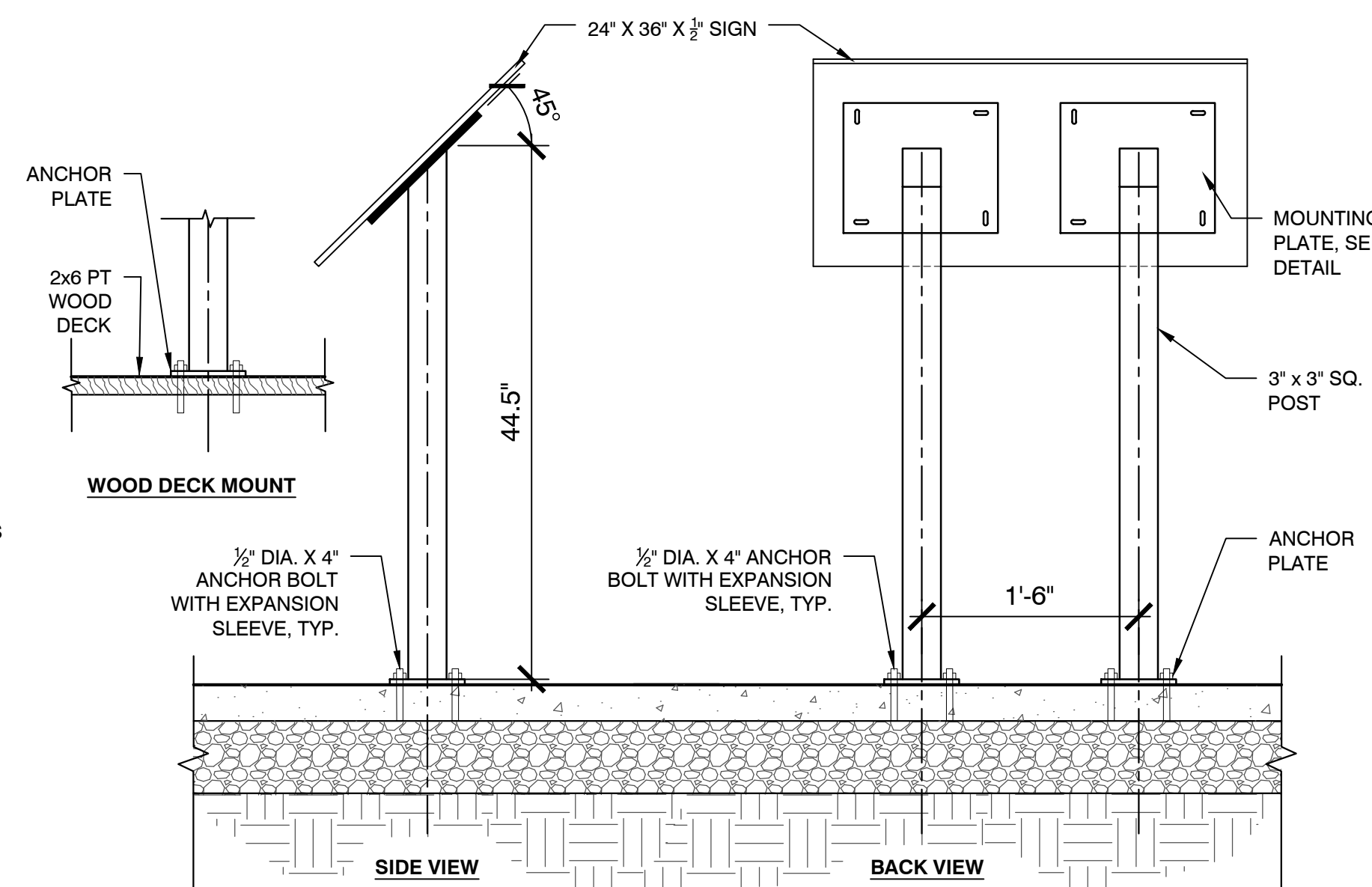

**8 INTERPRETIVE SIGNAGE - DOUBLE POST**  
SCALE: N.T.S.

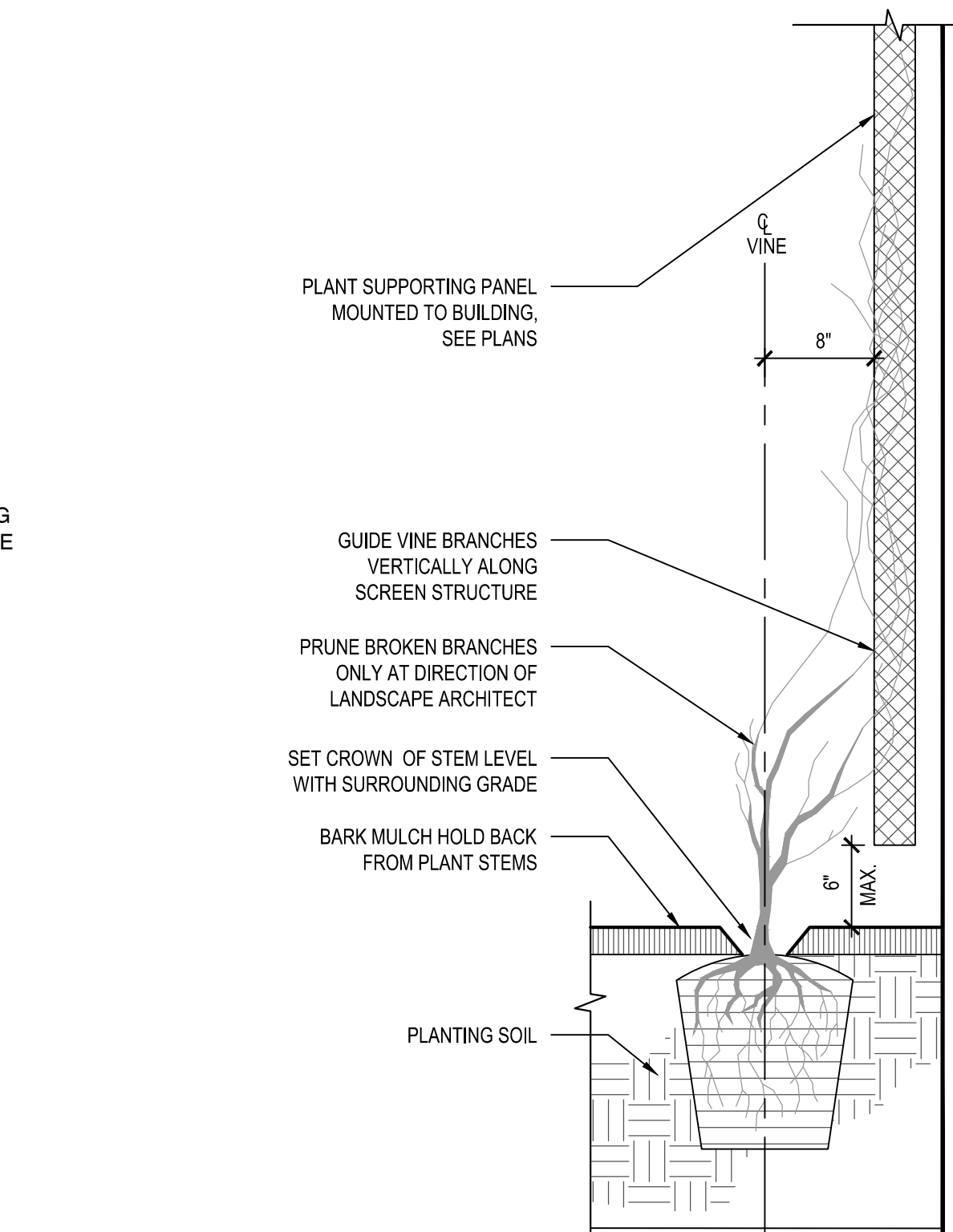

**9 GREEN SCREEN PLANTING AT FACE OF BUILDING**  
SCALE: N.T.S.

Consultants:

Revisions:

No.	Date	Description

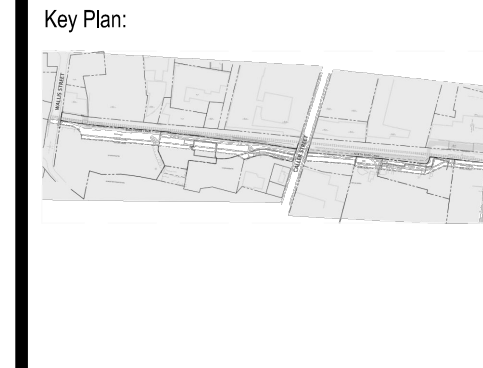

Issued For:  
**75% CONSTRUCTION DOCUMENTS**  
- NOT FOR CONSTRUCTION -

Scale: N.T.S.  
Date: APRIL 2021  
Drawn By: FD, TY, SG  
Reviewed By: CC  
Approved By: CFR

W&S Project No.: ENG20-0145  
W&S File No.:

Drawing Title:  
**CONSTRUCTION DETAILS**

Sheet Number:  
**L503**



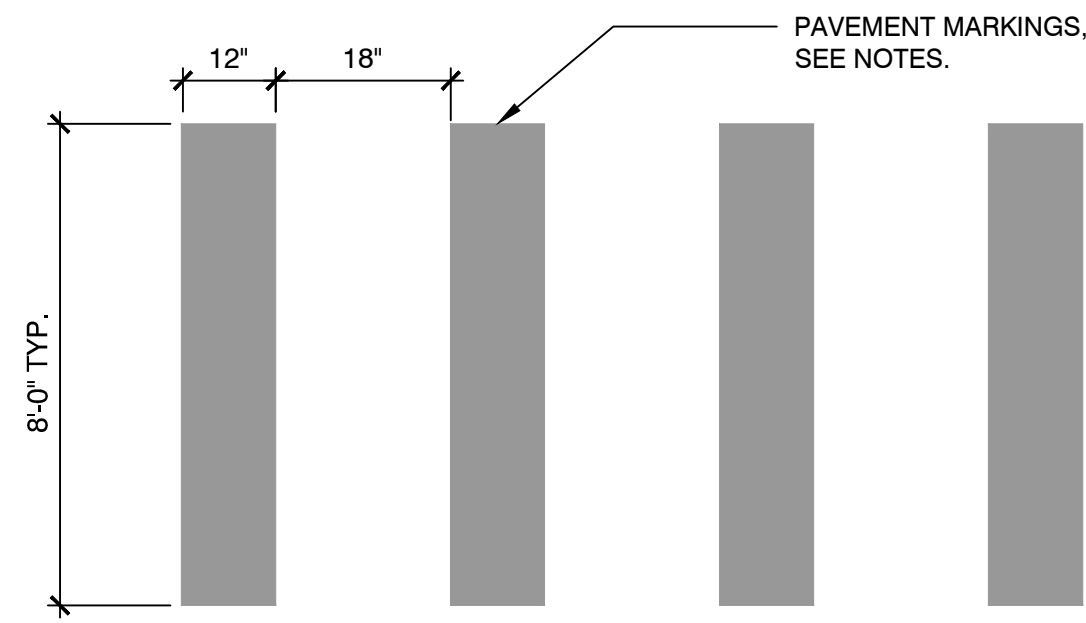

- NOTES:
1. PROVIDE PAVEMENT MARKINGS WHERE SHOWN ON PLANS IN ACCORDANCE WITH THIS DETAIL.
  2. PAVEMENT MARKINGS SHALL BE WHITE, REFLECTORIZED TRAFFIC PAINT CONFORMING TO FEDERAL SPECIFICATION TTP-1952B TRAFFIC PAINT, TYPE I OR II.

**1** CROSSWALK PAVEMENT MARKINGS  
SCALE: N.T.S.

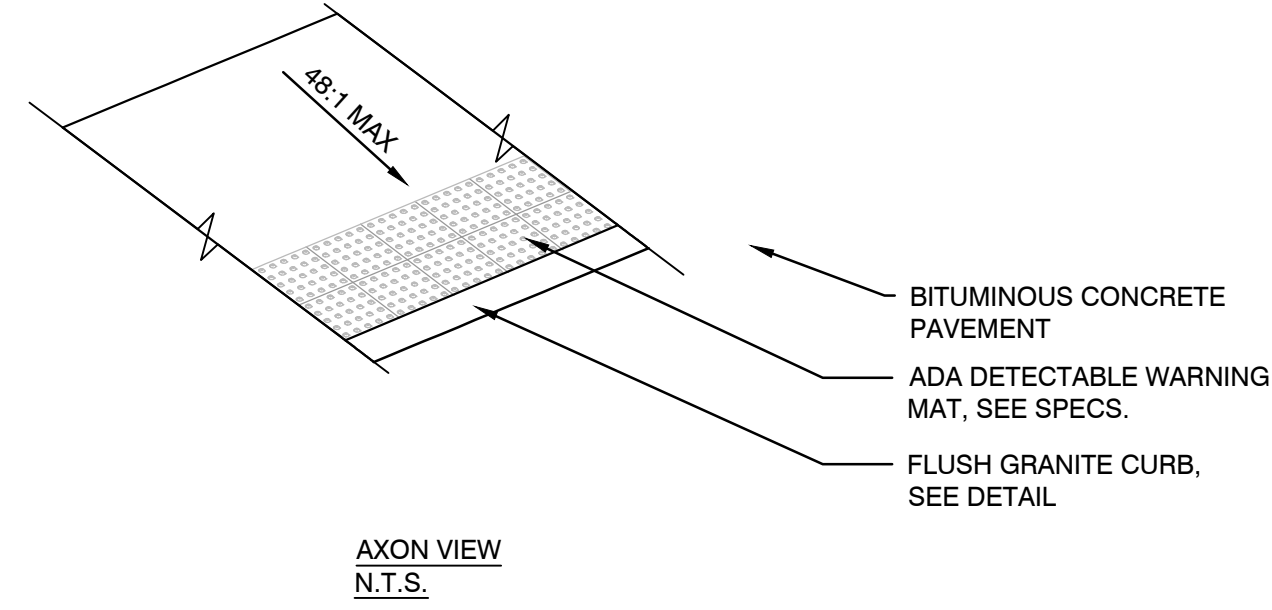

- BITUMINOUS CONCRETE PAVEMENT
- ADA DETECTABLE WARNING MAT, SEE SPECS.
- FLUSH GRANITE CURB, SEE DETAIL

**2** ADA ACCESSIBLE CURB CUT AT WALLIS STREET - WEST  
SCALE: N.T.S.

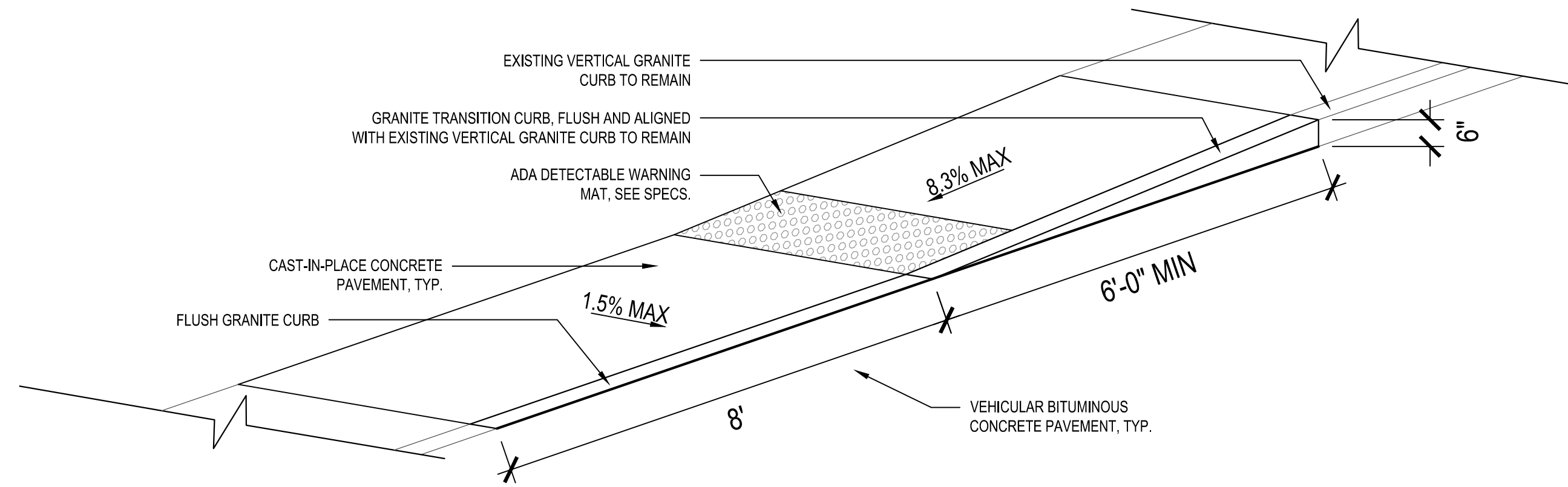

- NOTES:
1. CONTRACTOR SHALL PROVIDE CLEAN AND STRAIGHT SAWCUT LINES AT LIMIT OF REMOVAL OF EXISTING ASPHALT PAVEMENT TO REMAIN.
  2. CONTRACTOR SHALL VERIFY LIMITS OF EXISTING ASPHALT PAVEMENT REMOVAL PRIOR TO COMMENCING DEMOLITION.
  3. CONTRACTOR SHALL REMOVE AND REPLACE ASPHALT PAVEMENT, GRAVEL BORROW, AND SUBGRADE NECESSARY TO CONSTRUCT A CLEAN, SMOOTH TRANSITION AT ADA CURB CUT.

**3** ADA ACCESSIBLE CURB CUT AT WALLIS STREET - EAST  
SCALE: N.T.S.

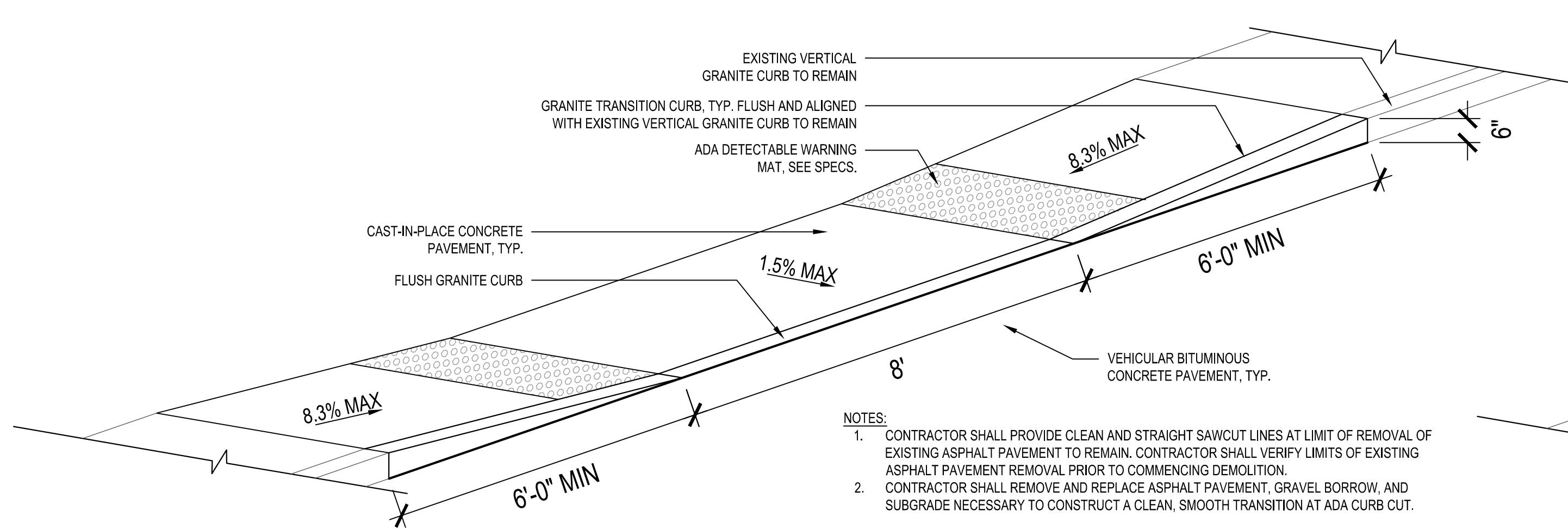

- NOTES:
1. CONTRACTOR SHALL PROVIDE CLEAN AND STRAIGHT SAWCUT LINES AT LIMIT OF REMOVAL OF EXISTING ASPHALT PAVEMENT TO REMAIN. CONTRACTOR SHALL VERIFY LIMITS OF EXISTING ASPHALT PAVEMENT REMOVAL PRIOR TO COMMENCING DEMOLITION.
  2. CONTRACTOR SHALL REMOVE AND REPLACE ASPHALT PAVEMENT, GRAVEL BORROW, AND SUBGRADE NECESSARY TO CONSTRUCT A CLEAN, SMOOTH TRANSITION AT ADA CURB CUT.

**4** ADA ACCESSIBLE CURB CUT AT CALLER STREET - WEST  
SCALE: N.T.S.

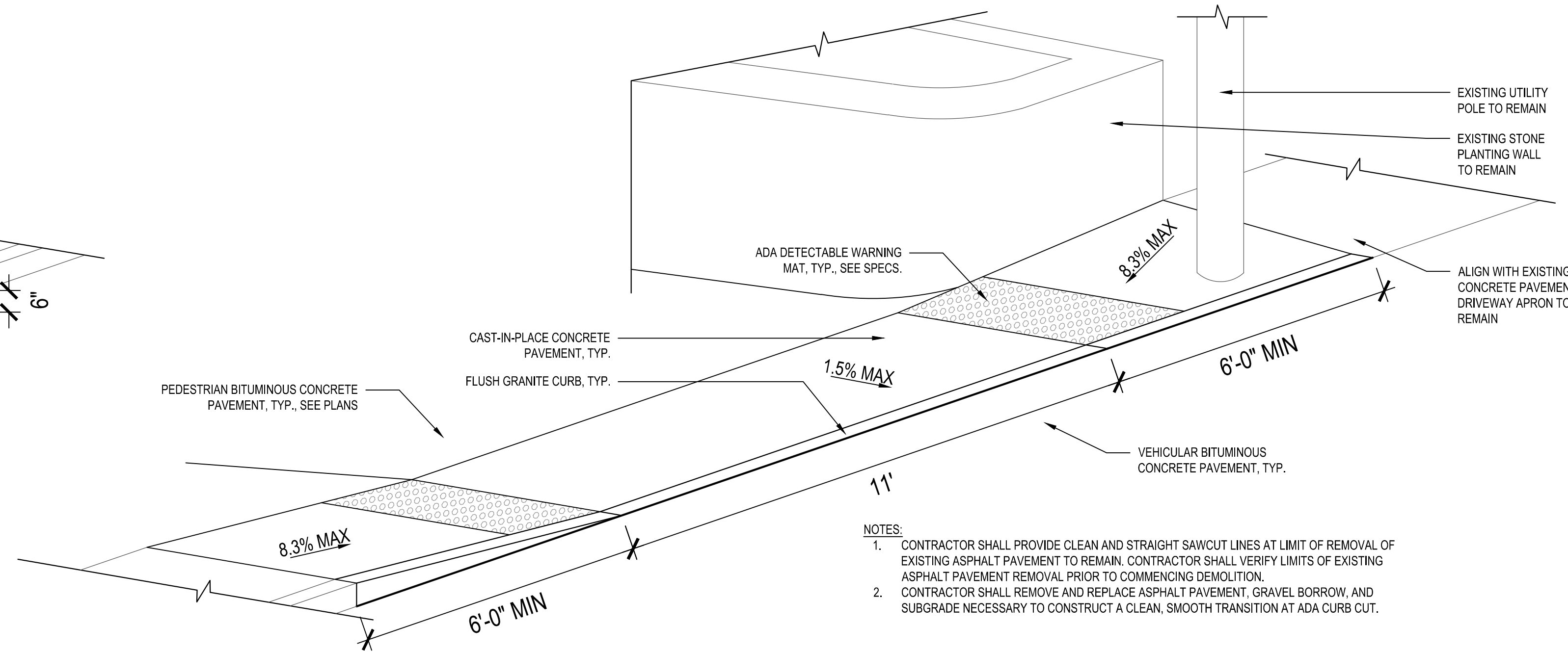

- NOTES:
1. CONTRACTOR SHALL PROVIDE CLEAN AND STRAIGHT SAWCUT LINES AT LIMIT OF REMOVAL OF EXISTING ASPHALT PAVEMENT TO REMAIN. CONTRACTOR SHALL VERIFY LIMITS OF EXISTING ASPHALT PAVEMENT REMOVAL PRIOR TO COMMENCING DEMOLITION.
  2. CONTRACTOR SHALL REMOVE AND REPLACE ASPHALT PAVEMENT, GRAVEL BORROW, AND SUBGRADE NECESSARY TO CONSTRUCT A CLEAN, SMOOTH TRANSITION AT ADA CURB CUT.

**5** ADA ACCESSIBLE CURB CUT AT CALLER STREET - EAST  
SCALE: N.T.S.

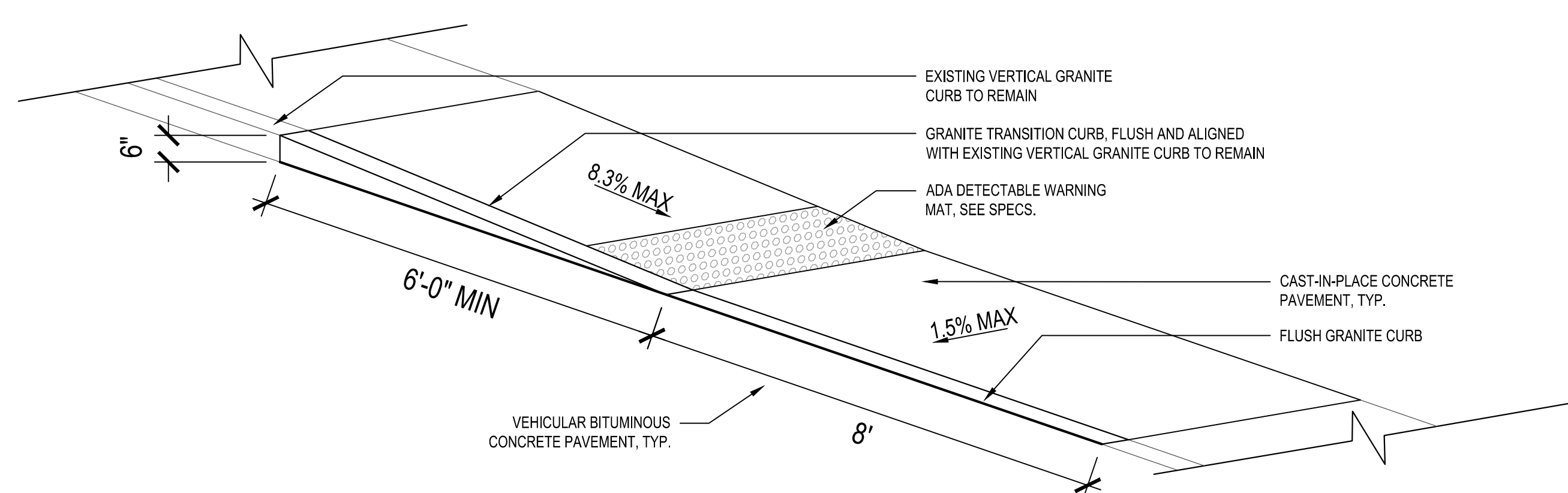

- NOTES:
1. CONTRACTOR SHALL PROVIDE CLEAN AND STRAIGHT SAWCUT LINES AT LIMIT OF REMOVAL OF EXISTING ASPHALT PAVEMENT TO REMAIN. CONTRACTOR SHALL VERIFY LIMITS OF EXISTING ASPHALT PAVEMENT REMOVAL PRIOR TO COMMENCING DEMOLITION.
  2. CONTRACTOR SHALL REMOVE AND REPLACE ASPHALT PAVEMENT, GRAVEL BORROW, AND SUBGRADE NECESSARY TO CONSTRUCT A CLEAN, SMOOTH TRANSITION AT ADA CURB CUT.

**6** ADA ACCESSIBLE CURB CUT AT HOWLEY STREET - WEST  
SCALE: N.T.S.

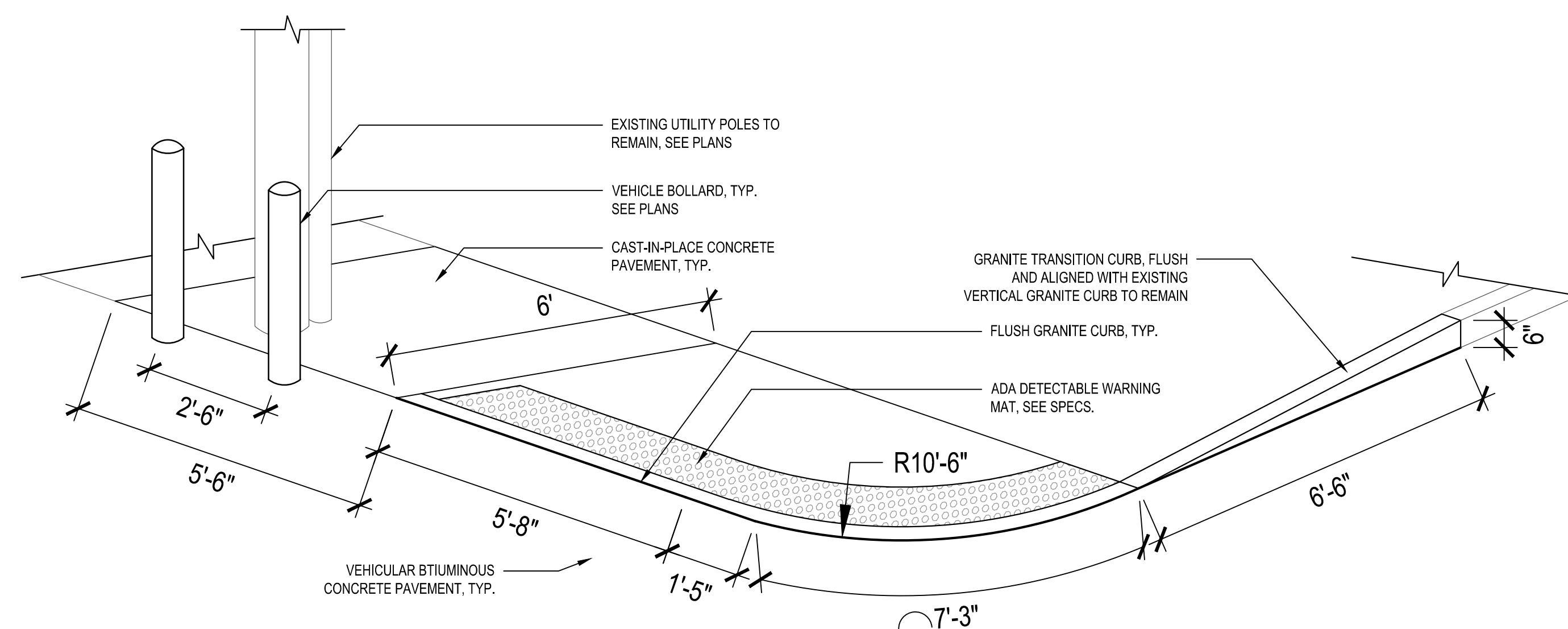

- NOTES:
1. ALL CROSS SLOPES SHALL NOT EXCEED 1.50%.
  2. CONTRACTOR SHALL PROVIDE CLEAN AND STRAIGHT SAWCUT LINES AT LIMIT OF REMOVAL OF EXISTING BITUMINOUS CONCRETE PAVEMENT TO REMAIN AT ROADWAY. CONTRACTOR SHALL VERIFY LIMITS OF EXISTING ASPHALT PAVEMENT REMOVAL PRIOR TO COMMENCING DEMOLITION.
  3. CONTRACTOR SHALL REMOVE AND REPLACE BITUMINOUS CONCRETE PAVEMENT, GRAVEL BORROW, AND SUBGRADE NECESSARY TO CONSTRUCT A CLEAN, SMOOTH TRANSITION AT ADA CURB CUT.

**7** ADA ACCESSIBLE CURB CUT AT HOWLEY STREET - EAST  
SCALE: N.T.S.

Consultants:

Revisions:

No.	Date	Description

Seal:

Key Plan:

Issued For:

75% CONSTRUCTION DOCUMENTS  
- NOT FOR CONSTRUCTION -

Scale: N.T.S.

Date: APRIL 2021

Drawn By: FD, TY, SG

Reviewed By: CC

Approved By: CFR

W&S Project No.: ENG20-0145

W&S File No.:



Revisions:

No.	Date	Description

Key Plan:



Issued For:  
**75% CONSTRUCTION  
 DOCUMENTS**  
 - NOT FOR CONSTRUCTION -

Scale: N.T.S.  
 Date: APRIL 2021  
 Drawn By: FD, TY, SG  
 Reviewed By: CC  
 Approved By: CFR  
 W&S Project No.: ENG20-0145  
 W&S File No.:

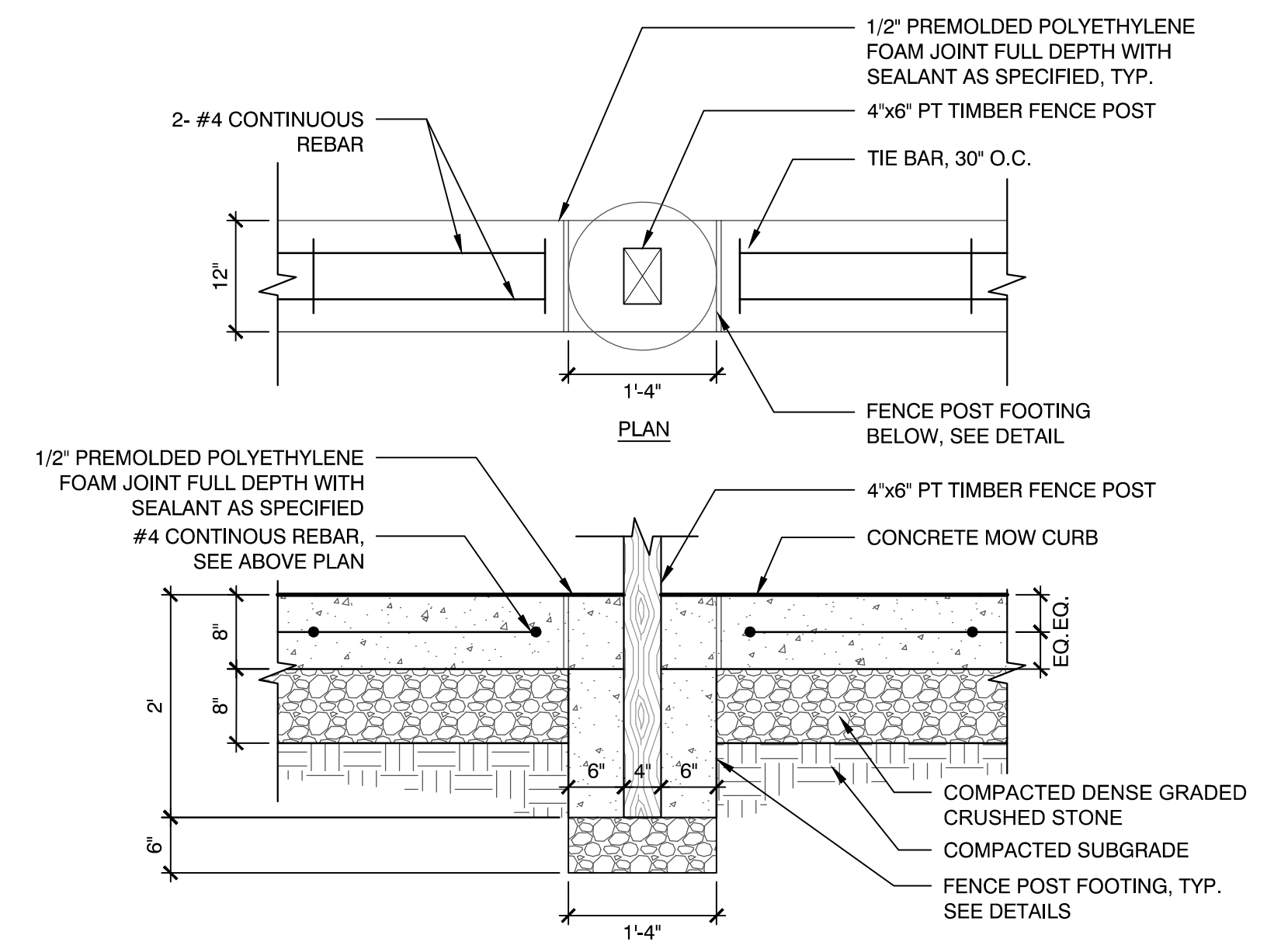

**NOTES:**  
 1. MOW CURB CORNERS ADJACENT TO WALLS AND CURBS SHALL BE SQUARE TO ENSURE SMOOTH INTERFACE BETWEEN MATERIALS.  
 2. MOW CURB CORNERS ADJACENT TO PLANTING BED OR LAWN AREAS SHALL HAVE 1/2\"/>

**1 MOW CURB AT FENCE**  
 SCALE: N.T.S.

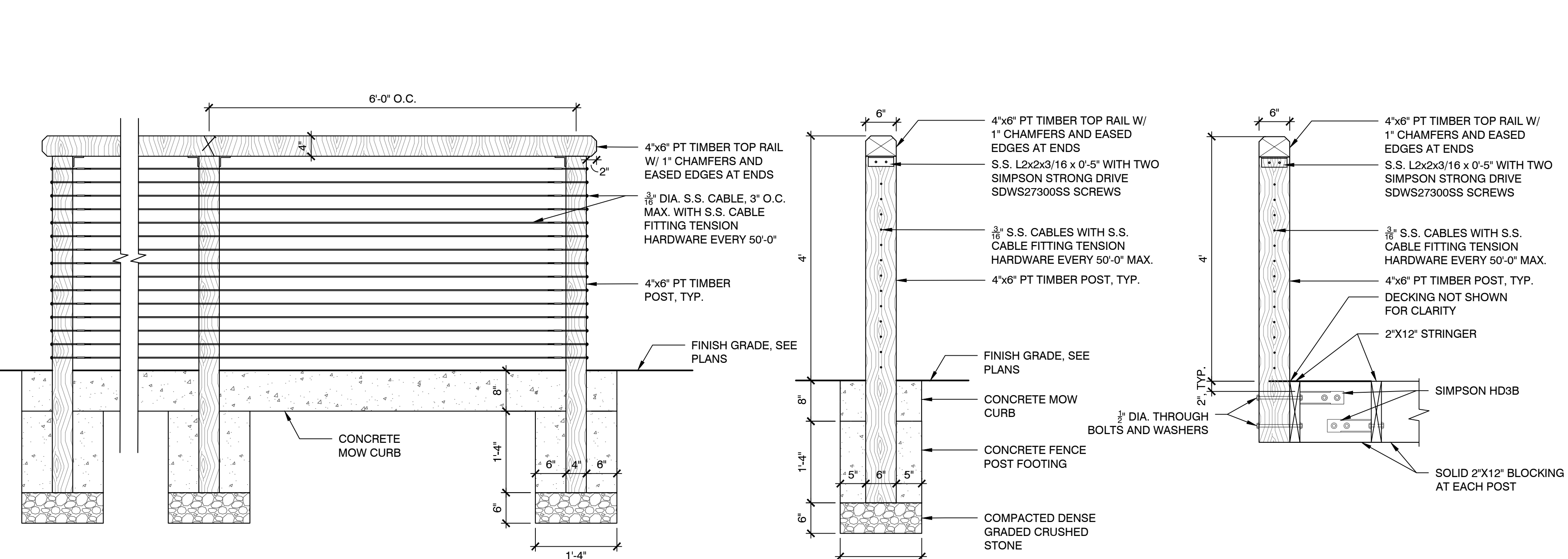

**2 FENCE WITH CABLE RAILING**  
 SCALE: N.T.S.

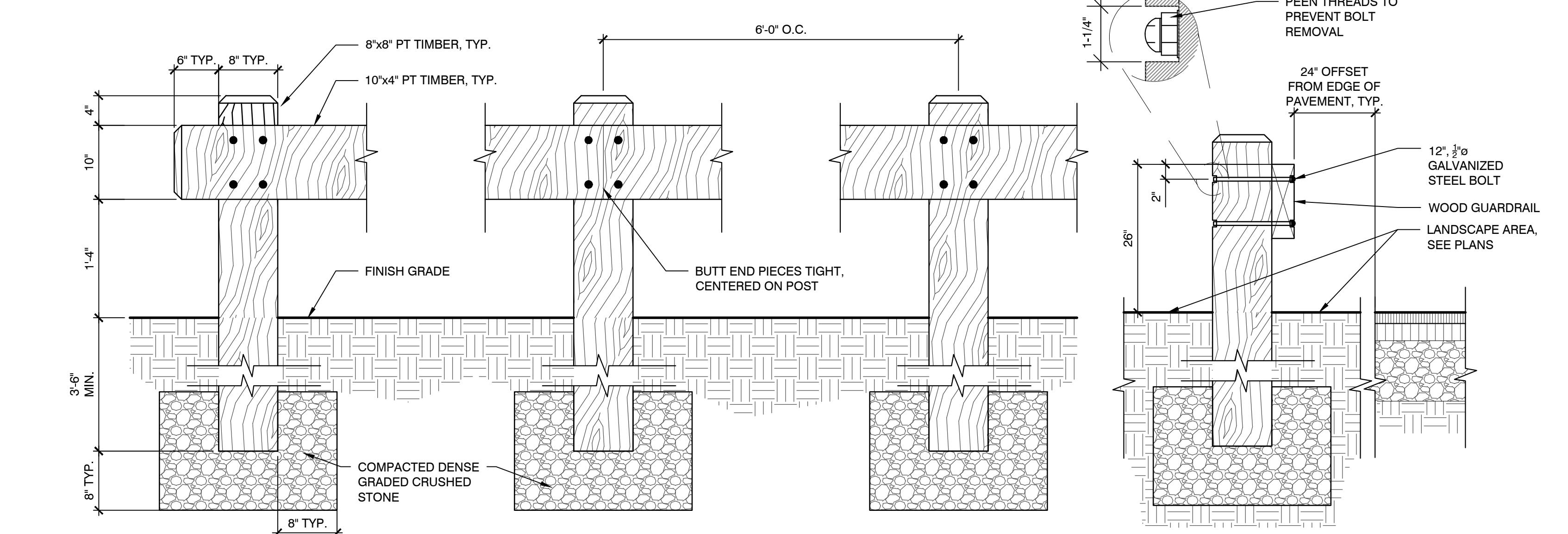
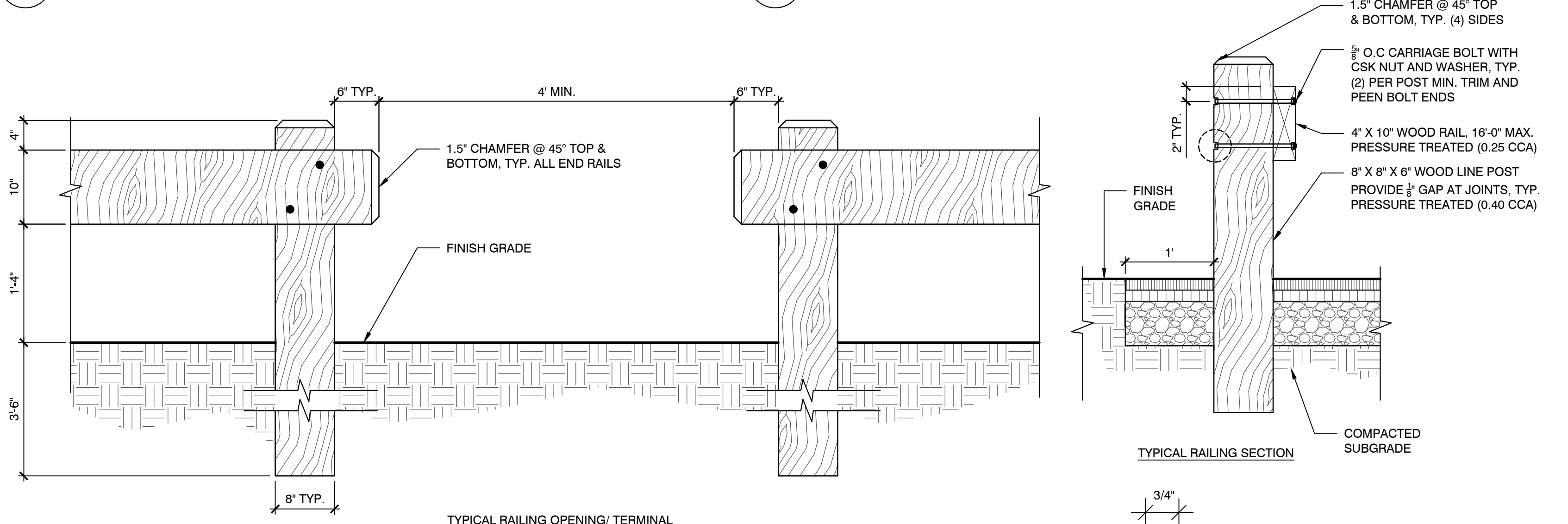

**3 WOOD GUARDRAIL**  
 SCALE: N.T.S.

**4 CIP CONCRETE RETAINING WALL WITH DENSE GRADED CRUSHED STONE BACKFILL**  
 SCALE: N.T.S.



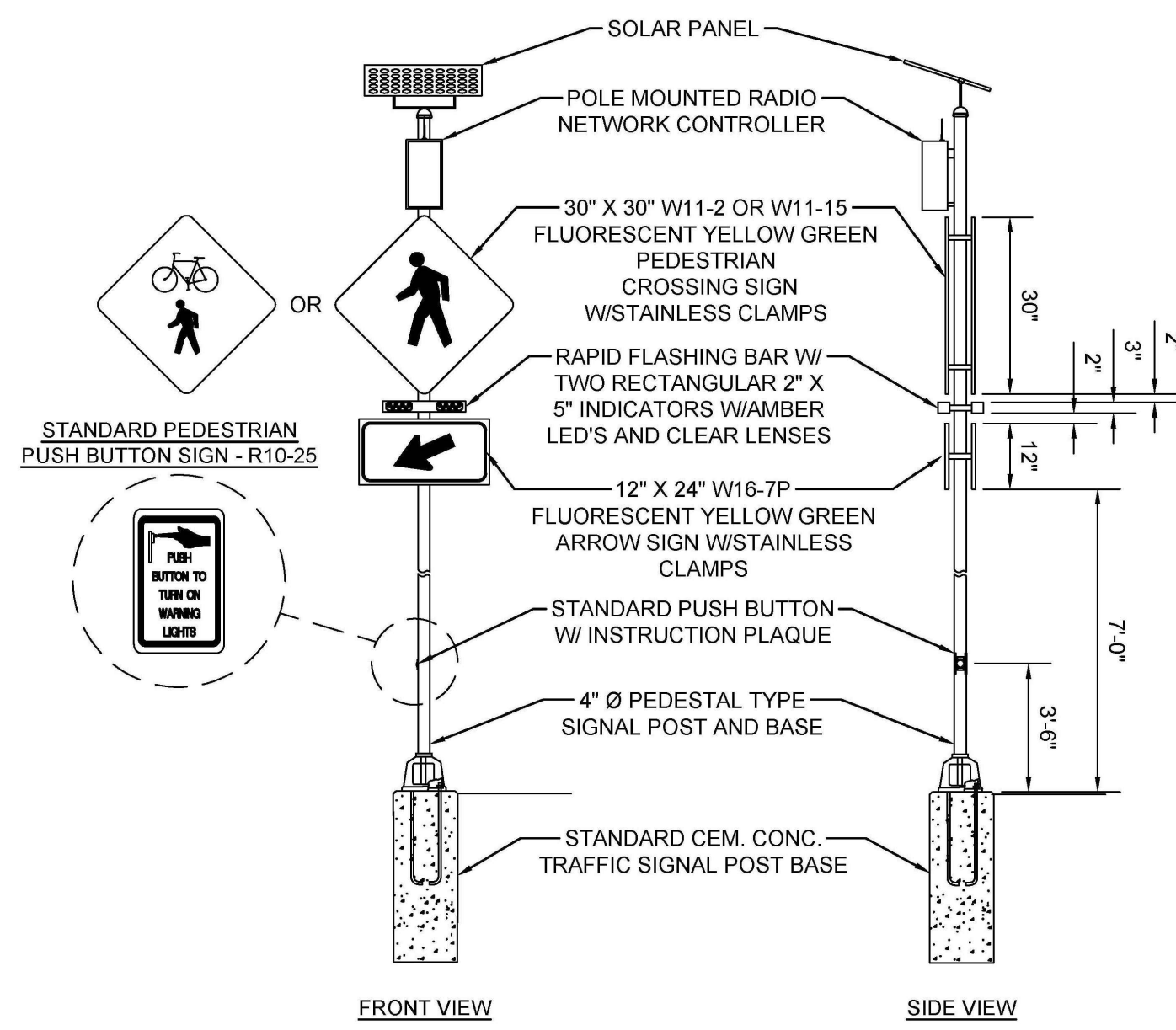

**1 RAPID FLASHING BEACON**  
SCALE: N.T.S.

- RRFB NOTES:**
- RECTANGULAR RAPID FLASHING BEACON (RRFB) SHALL BE SUPPLIED FROM A MANUFACTURER LISTED ON THE MASSDOT APPROVED EQUIPMENT LIST.
  - EACH LOCATION SHALL HAVE TWO (2) RRFB INSTALLED (ONE ON EACH SIDE OF THE CROSSWALK).
  - LOCATIONS 1 AND 3 WILL USE SIGN W11-15 AND LOCATION 2 WILL USE SIGN W11-2.
  - R10-25 SIGNS SHALL BE INSTALLED ABOVE ALL PEDESTRIAN PUSH BUTTONS.
  - OPERABLE CONTROLS ON RRFB SHALL BE LOCATED PER ADA STANDARDS 305-309
  - WARNING SIGNS AND INSTRUCTIONAL SIGNS ARE PAID SEPARATELY UNDER ITEM 832.
- | RRFB CLEARANCE TIME |             |               |
|---------------------|-------------|---------------|
| APPROACH            | LENGTH (ft) | CLEARANCE (s) |
| LOCATION 1          | 40          | 14            |
| LOCATION 2          | 36          | 12            |
| LOCATION 3          | 34          | 12            |

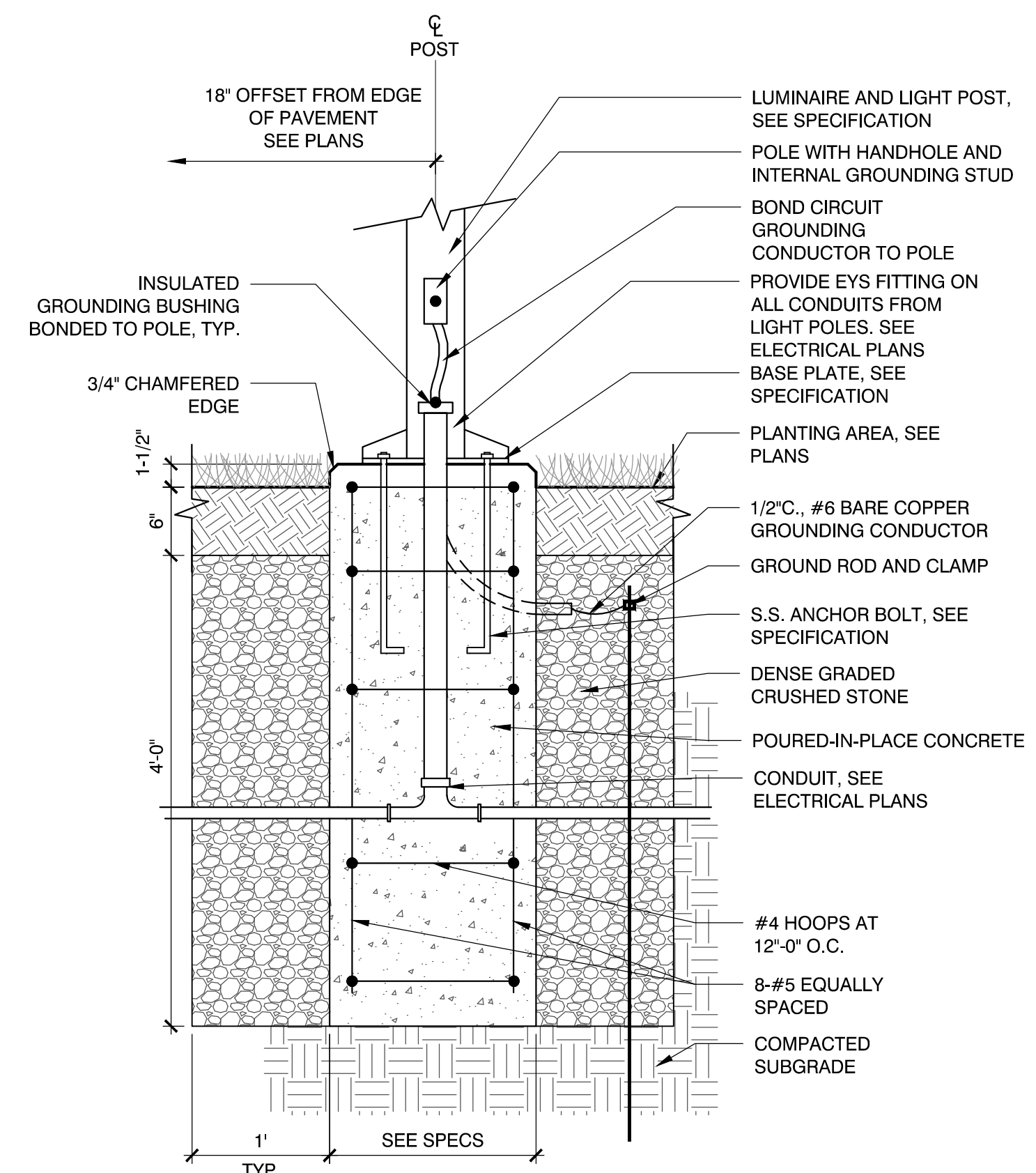

**2 LIGHT POST FOOTING**  
SCALE: N.T.S.

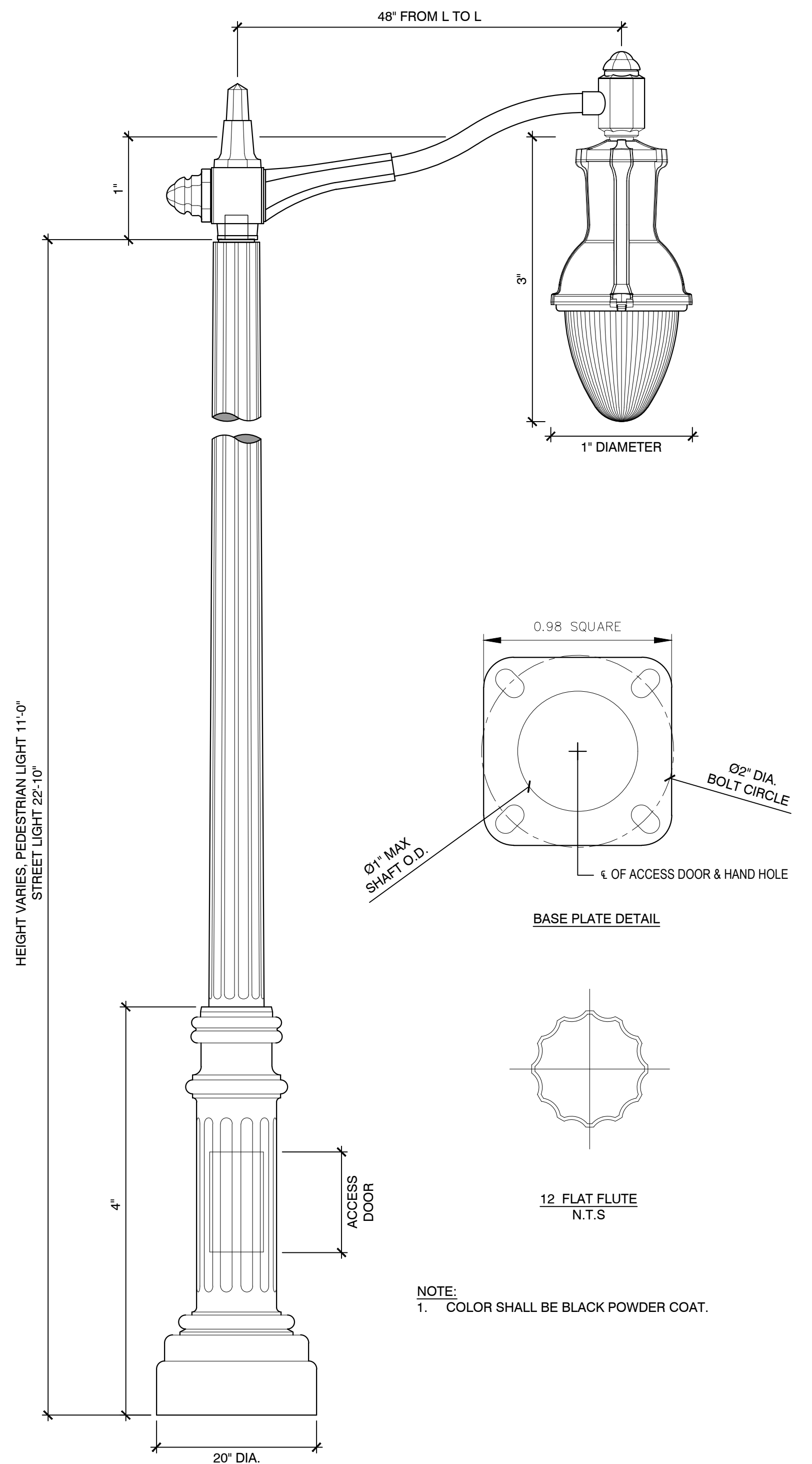

**3 PEDESTRIAN AND STREET LIGHT**  
SCALE: N.T.S.

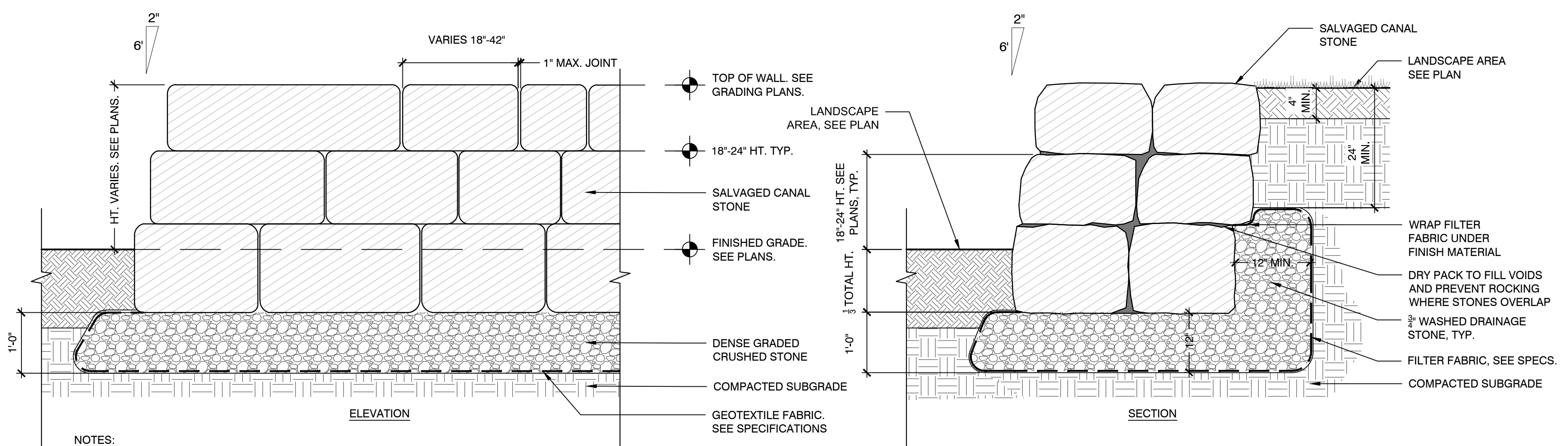

- NOTES:**
- BLOCK SELECTION SHALL BE BY OWNER'S REPRESENTATIVE.
  - FINAL LOCATION AND LAYOUT SHALL BE BY OWNER'S REPRESENTATIVE IN FIELD. CONTRACTOR SHALL ASSUME PLACEMENT OF EACH BLOCK A MINIMUM OF 3 TIMES.
  - CONTRACTOR SHALL PROVIDE 6x2 BATTER FOR EACH ROW OF STONE.
  - JOINT BETWEEN BOULDER AND ADJACENT MATERIAL SHALL NOT EXCEED 1/2". STRIPPED TOP SHALL BE FILLED WITH POLYMERIC SAND.
  - CONTRACTOR SHALL FILL VOIDS BETWEEN STONES USING TRAP ROCK. TRAP ROCK SHALL BE SECURELY PLACED TO PREVENT REMOVAL.

**4 SALVAGED CANAL STONE RETAINING WALL**  
SCALE: N.T.S.

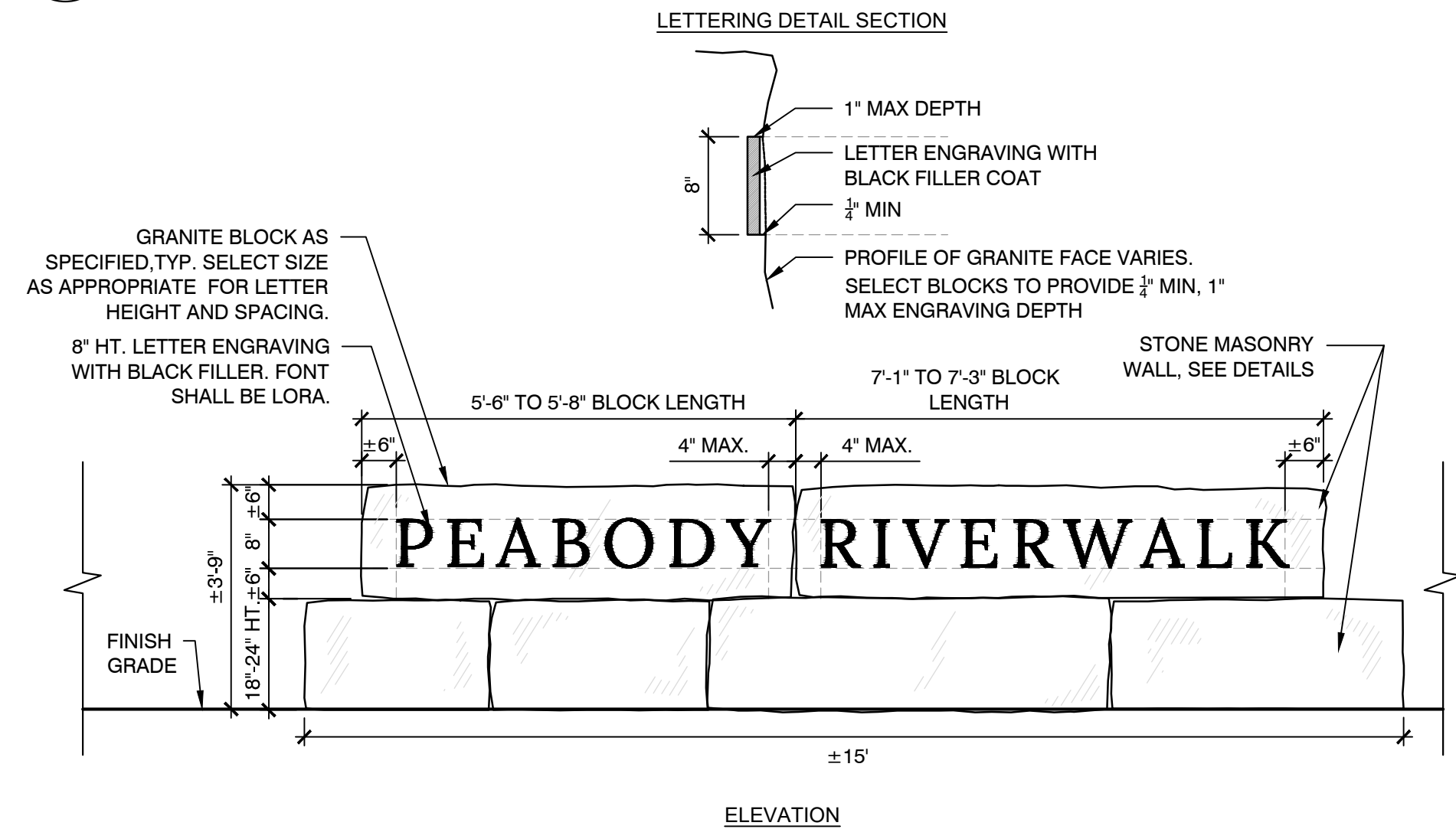

**5 GRANITE BLOCK RIVERWALK ENTRY SIGN**  
SCALE: N.T.S.



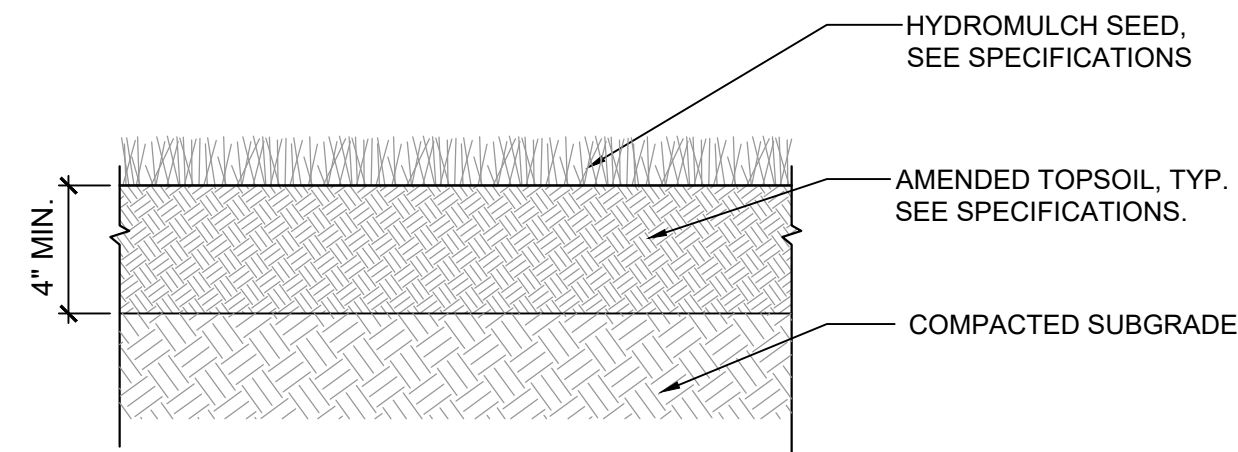

**1 LOAM AND SEED**  
SCALE: N.T.S.

GROUND COVER SPACING TABLE

PLANT SPACING "A"	ROW SPACING "B"	PLANTS	AREA UNIT
6" O.C.	5.2"	4.61	1 SQ. FT.
8" O.C.	6.93"	2.6	1 SQ. FT.
10" O.C.	8.66"	1.66	1 SQ. FT.
12" O.C.	10.4"	1.15	1 SQ. FT.

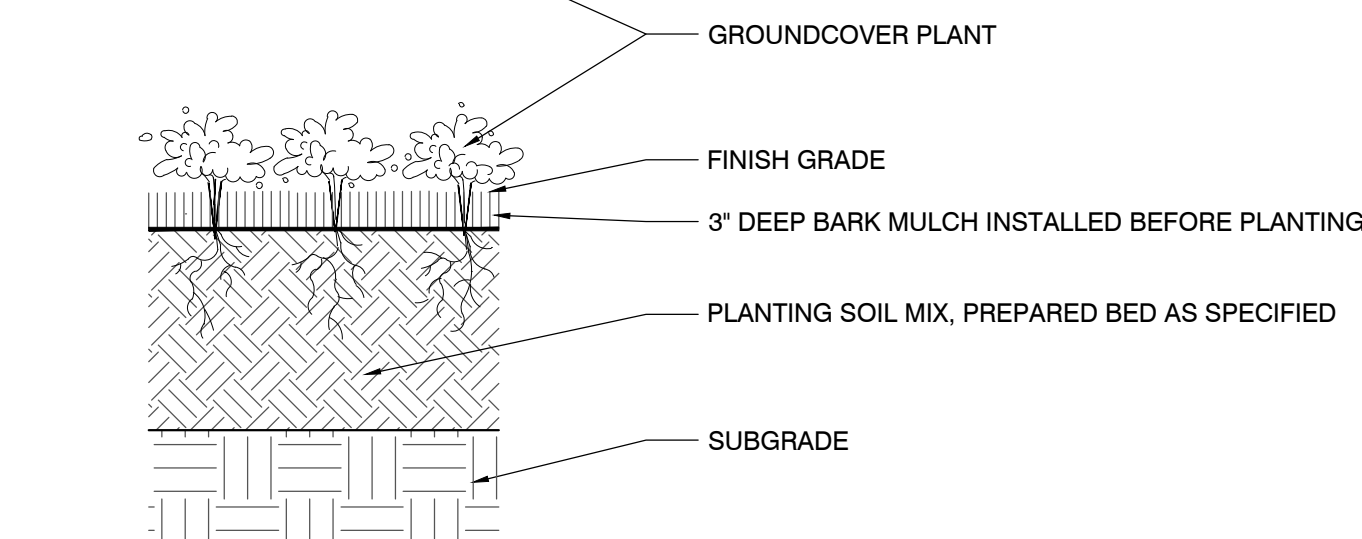

- NOTES:  
1. ALL GROUND COVER TO BE PLANTED IN TRIANGULAR PATTERN. SEE DETAIL PLAN AND GROUND COVER SPACING TABLE.  
2. JUTE EROSION CONTROL MAT TO BE USED ON ALL SLOPES GREATER THAN 3:1

**2 GROUND COVER PLANTING**  
SCALE: N.T.S.

HERBACEOUS PERENNIAL & FERN SPACING TABLE

PLANT SPACING "A"	PLANT SPACING "B"	PLANTS	AREA UNIT
6" O.C.	5.2"	4.61	1 SQ. FT.
8" O.C.	6.93"	2.6	1 SQ. FT.
10" O.C.	8.66"	1.66	1 SQ. FT.
12" O.C.	10.4"	1.15	1 SQ. FT.

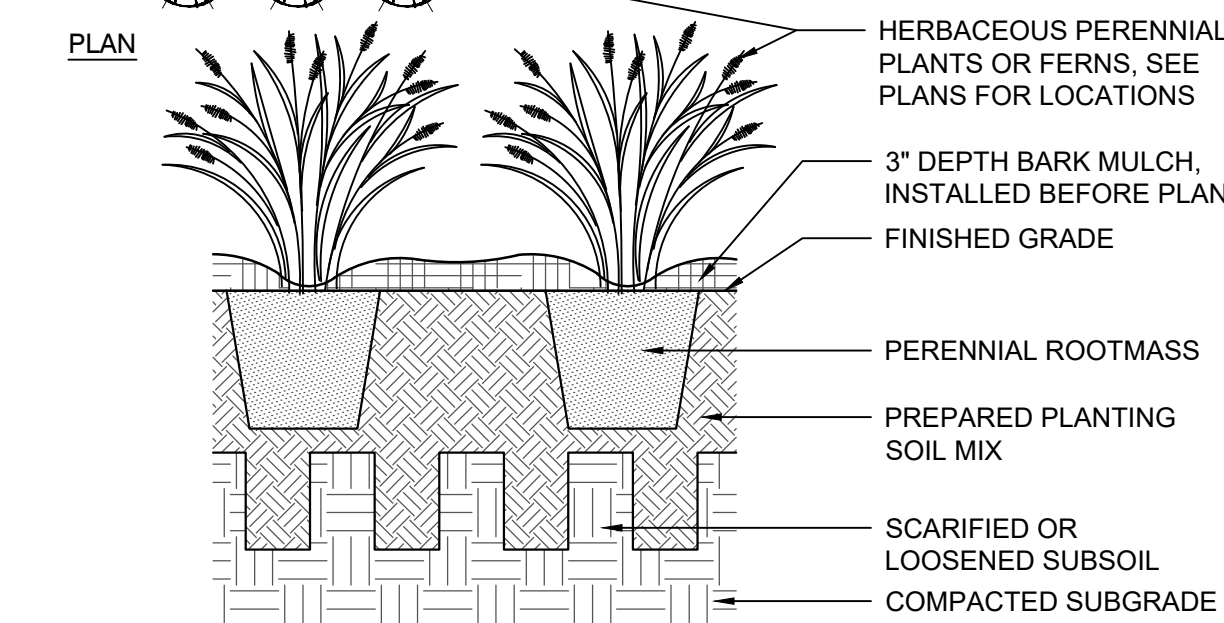

- NOTES:  
1. ALL GROUND COVERS TO BE PLANTED IN TRIANGULAR PATTERN. SEE PLANTING SCHEDULE FOR SPACING.

**3 HERBACEOUS PERENNIAL**  
SCALE: N.T.S.

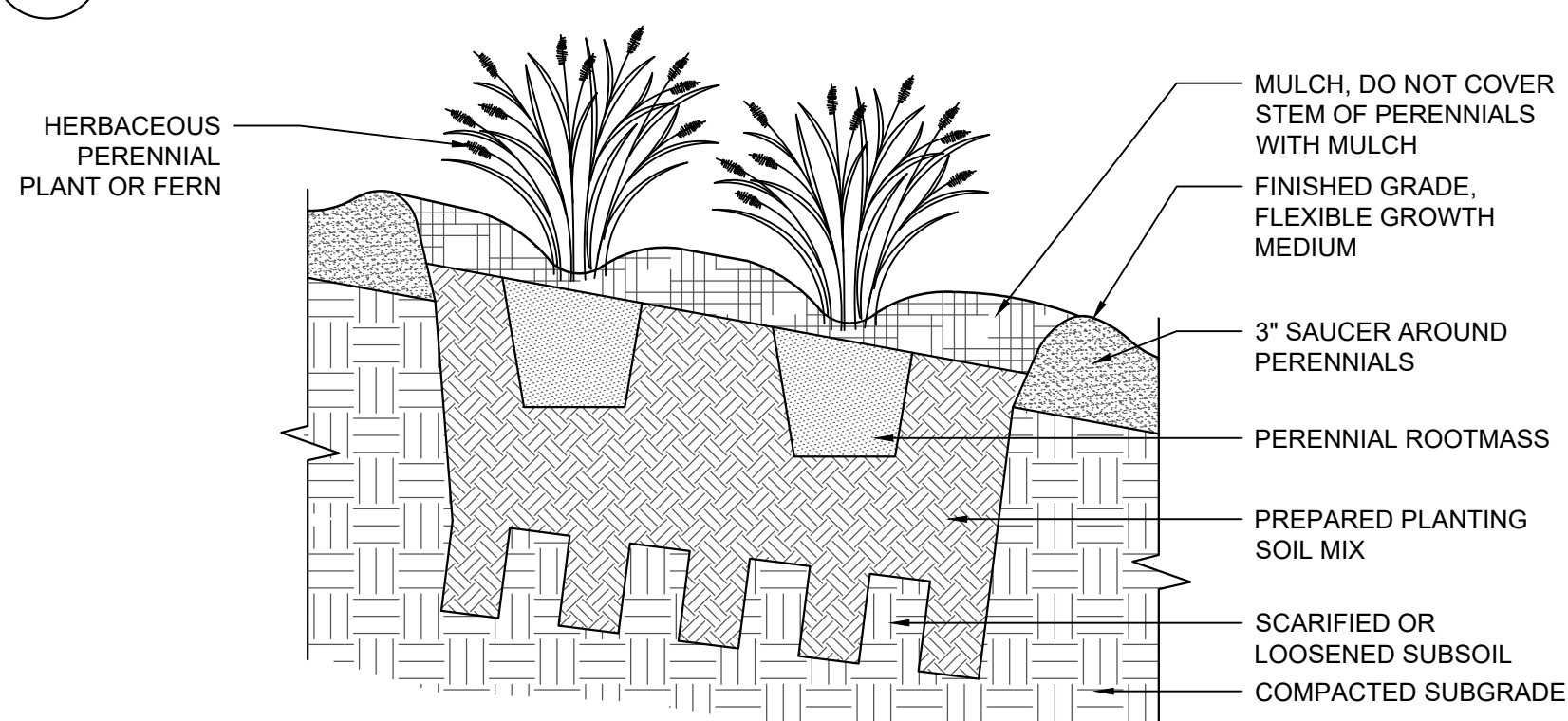

- NOTES:  
1. SEE GRADING PLAN FOR SLOPE GRADE.  
2. ALL MULCH MUST BE DARK IN COLOR. PROVIDE SAMPLE PRIOR TO INSTALLATION TO BE APPROVED BY OWNER'S REPRESENTATIVE.

**4 HERBACEOUS PERENNIAL ON SLOPE**  
SCALE: N.T.S.

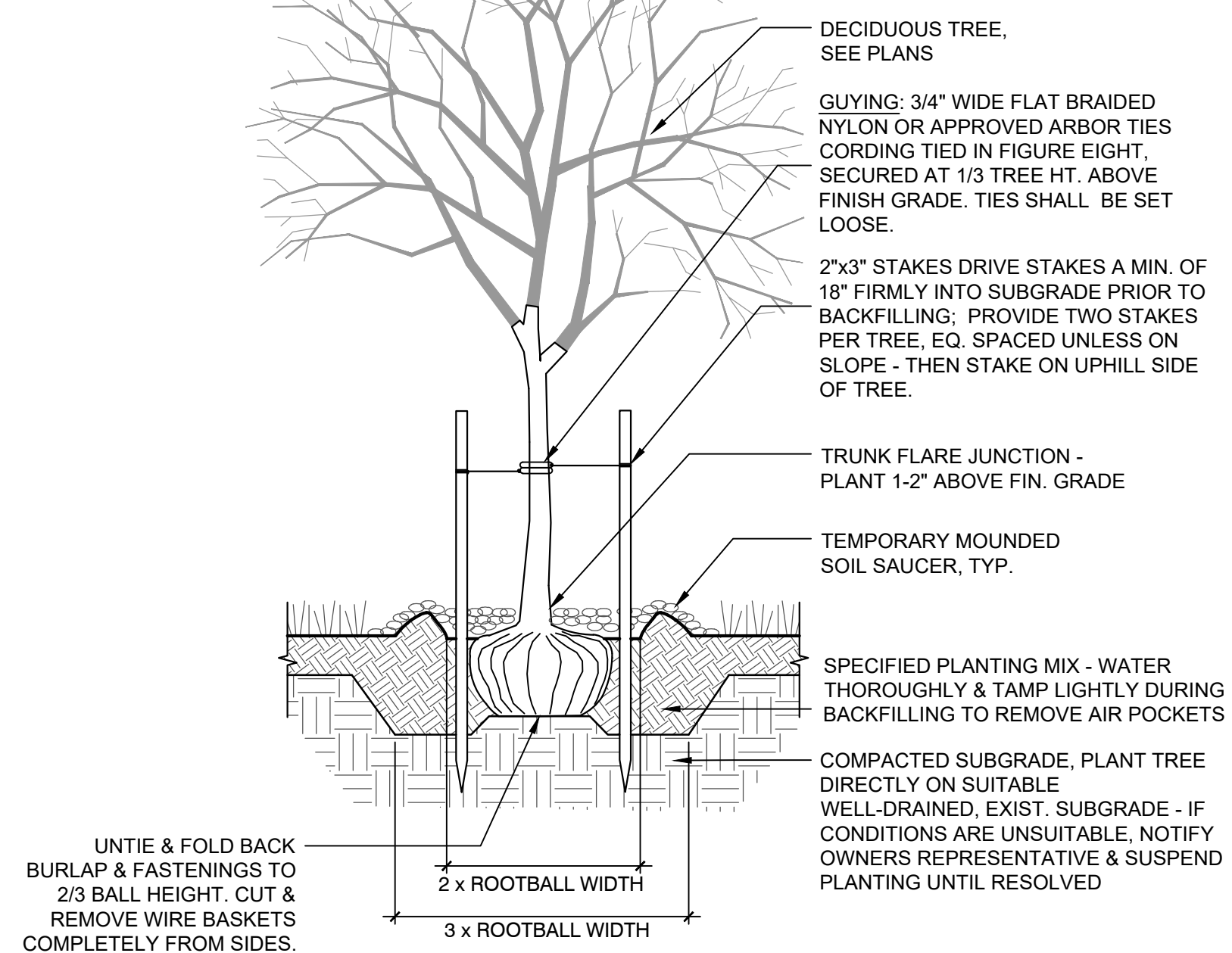
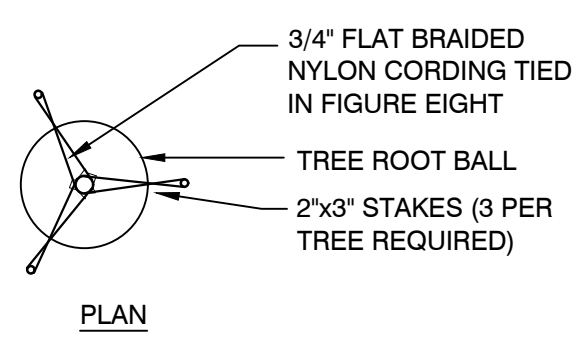

**5 TREE PLANTING AND STAKING - DECIDUOUS**  
SCALE: N.T.S.

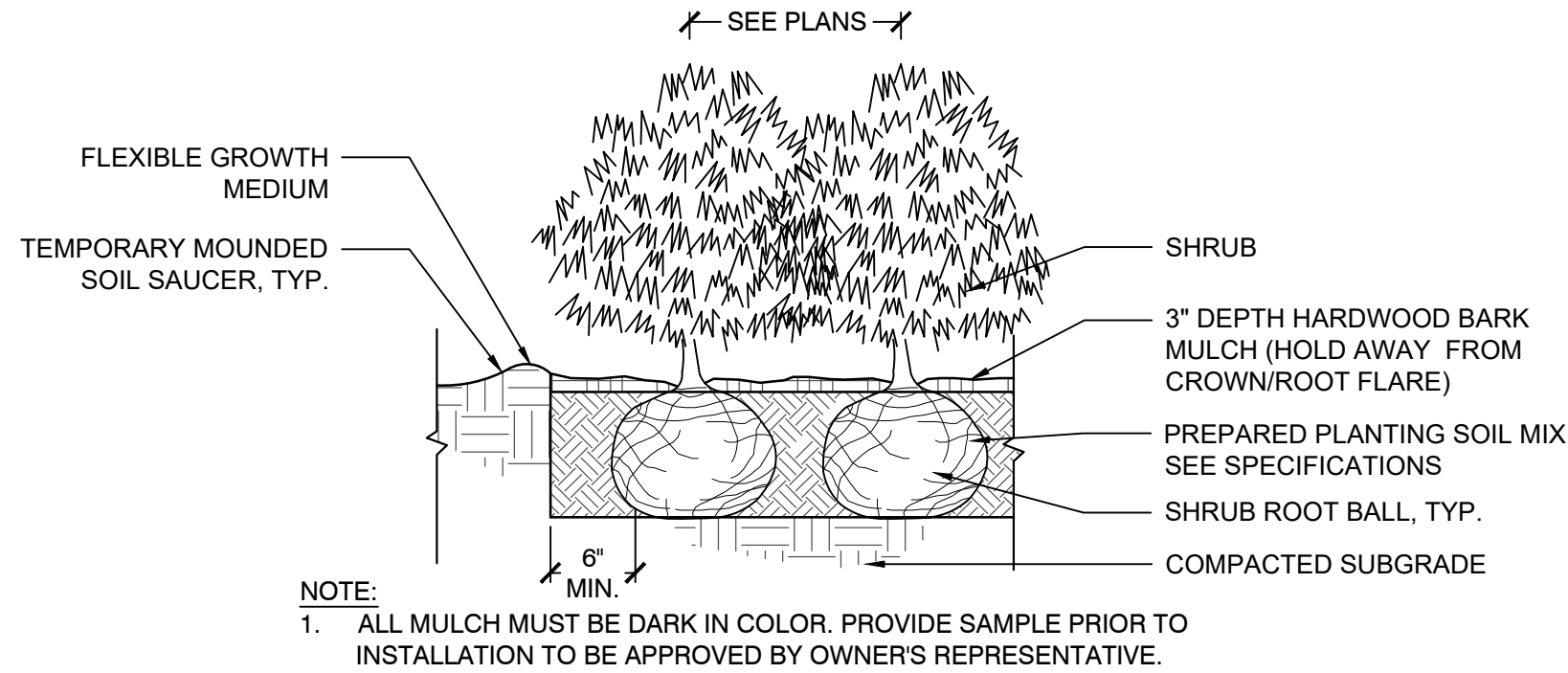

- NOTE:  
1. ALL MULCH MUST BE DARK IN COLOR. PROVIDE SAMPLE PRIOR TO INSTALLATION TO BE APPROVED BY OWNER'S REPRESENTATIVE.

**6 SHRUB PLANTING**  
SCALE: N.T.S.

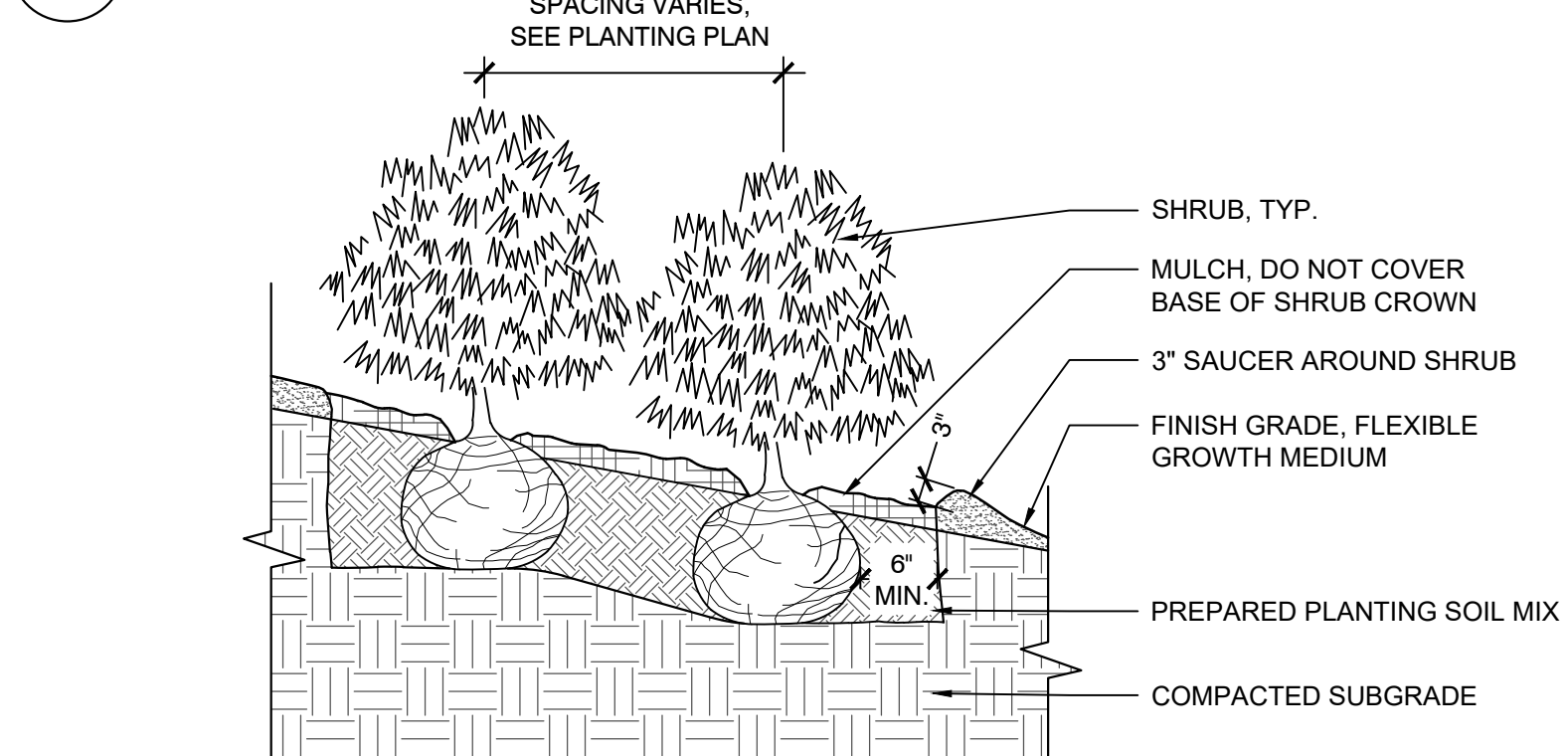

- NOTES:  
1. SEE GRADING PLAN FOR SLOPE GRADE.  
2. ALL MULCH MUST BE DARK IN COLOR. PROVIDE SAMPLE PRIOR TO INSTALLATION TO BE APPROVED BY OWNER'S REPRESENTATIVE.

**7 SHRUB PLANTING ON SLOPE**  
SCALE: N.T.S.

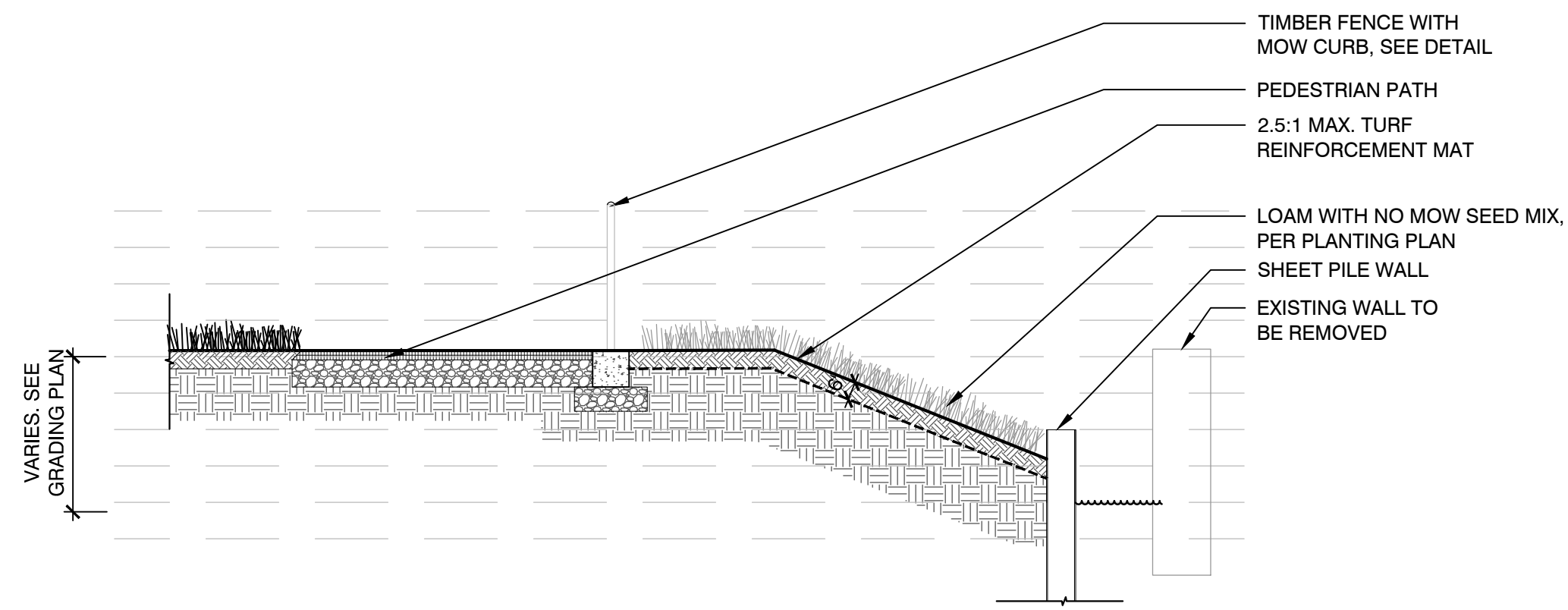

**8 SLOPE WITH TURF REINFORCEMENT MAT, LOAM AND EROSION CONTROL**  
SCALE: N.T.S.

Consultants:

Revisions:

No.	Date	Description

Key Plan:

Issued For:

75% CONSTRUCTION DOCUMENTS  
- NOT FOR CONSTRUCTION -

Scale: N.T.S.  
Date: APRIL 2021  
Drawn By: FD, TY, SG  
Reviewed By: CC  
Approved By: CFR

W&S Project No.: ENG20-0145  
W&S File No.:

Drawing Title:  
**CONSTRUCTION DETAILS**

Sheet Number:  
**L507**



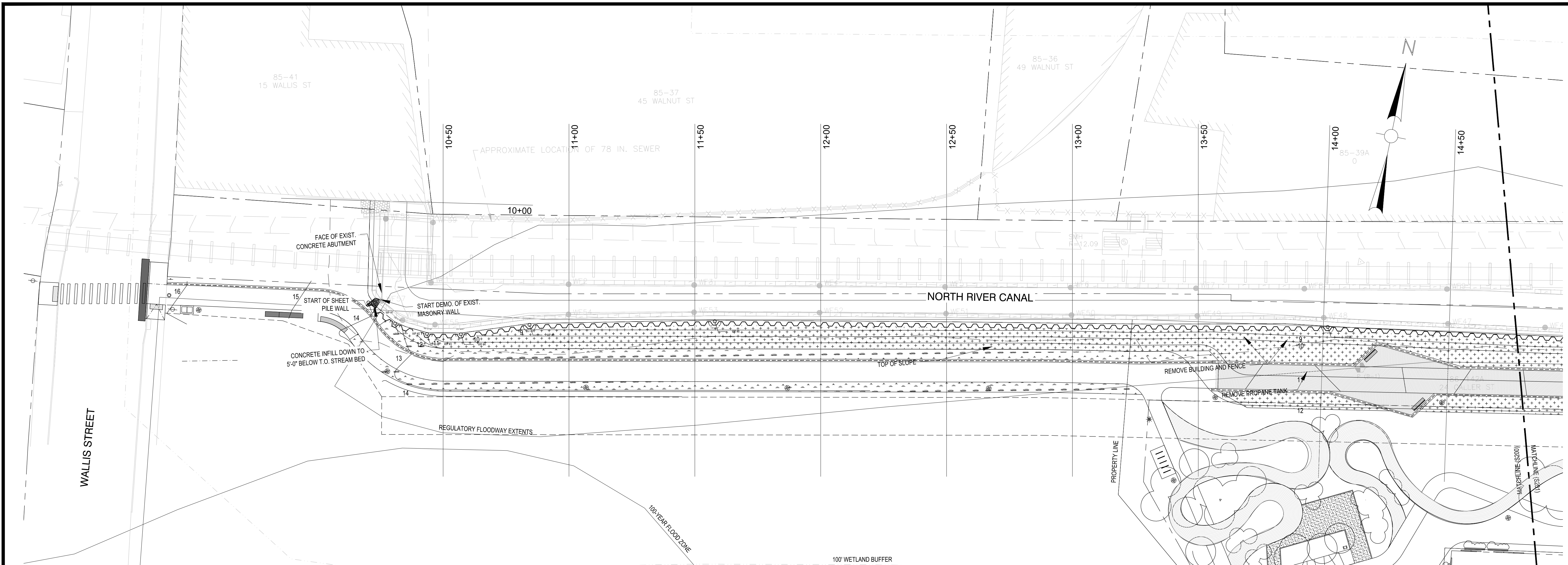

PLAN  
SCALE: 1" = 20'-0"

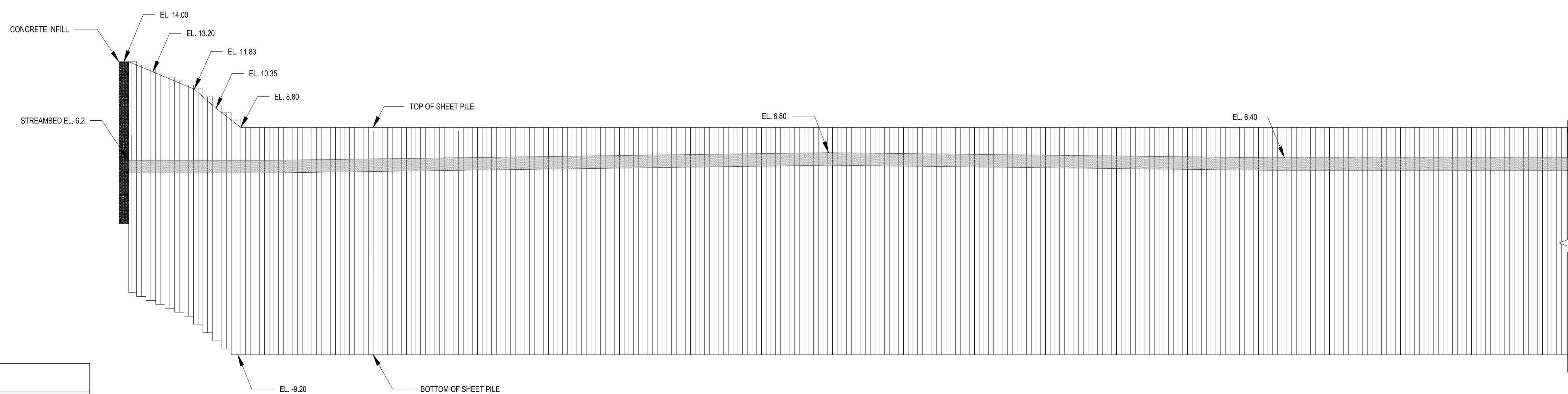

ELEVATION - SHEET PILE WALL  
HORIZONTAL SCALE: 1" = 20'  
VERTICAL SCALE: 1" = 1'

WORKING POINT TABLE		
WP #	NORTHING	EASTING
1	3120217.9090	-160733.36930
2	3120209.38300	-160722.86670
3	3120205.11650	-160710.25810
4	3120204.84670	-160696.80040
5	3120208.31540	-160669.47910
6	3120208.85690	-160595.88510
7	3120204.00420	-160352.44290

Project:  
**PEABODY RIVERWALK**

RIVERWALK PARK DESIGN PLANS  
CALLER STREET - HOWLEY STREET  
PEABODY, MA. 01960

**Weston & Sampson**  
WESTON & SAMPSON ENGINEERS, INC.  
85 DEVONSHIRE STREET, 3RD FLOOR  
BOSTON, MA 02109  
617-412-4480  
www.westonandsampson.com

Consultants:

--	--

Revisions:

No.	Date	Description

Seal:

Issued For:  
**75% DESIGN PLANS**

Scale: 1" = 20'  
Date: 03/11/2021  
Drawn By: HLB  
Reviewed By: SYC  
Approved By: SRB

W&S Project No.: ENG20-0145  
W&S File No.:

Drawing Title:  
**PROPOSED LAYOUT PLAN I**

Sheet Number:  
**S200**

P:\Projects\2020\0145\0145-01\0145-01.dwg



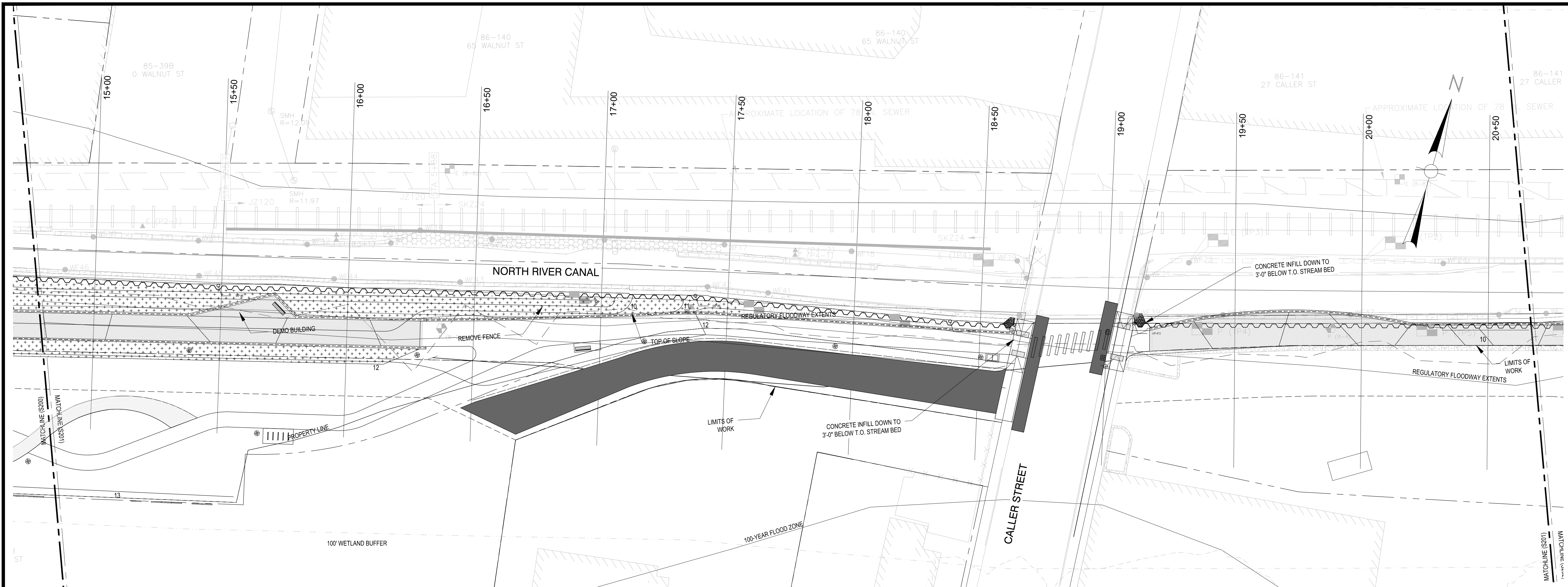

PLAN  
SCALE: 1" = 20'-0"

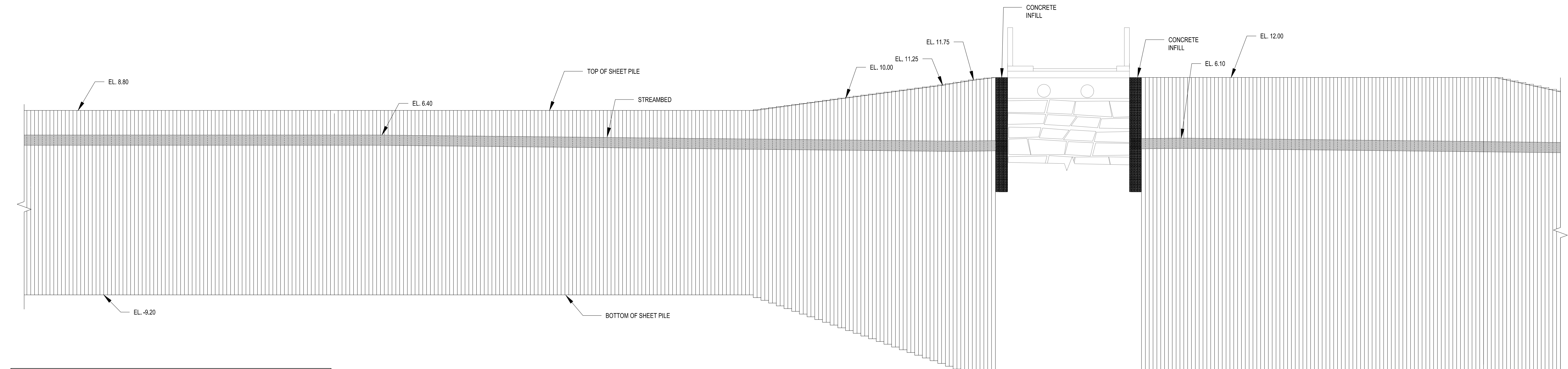

ELEVATION - SHEET PILE WALL  
HORIZONTAL SCALE: 1" = 20'  
VERTICAL SCALE: 1" = 4'

WORKING POINT TABLE		
WP #	NORTHING	EASTING
8	3120195.9003	-160205.6708
9	3120189.8658	-160017.4002
10	3120178.6442	-159916.9494
11	3120177.0231	-159891.7712
12	3120177.0638	-159844.1990

Project:  
**PEABODY RIVERWALK**

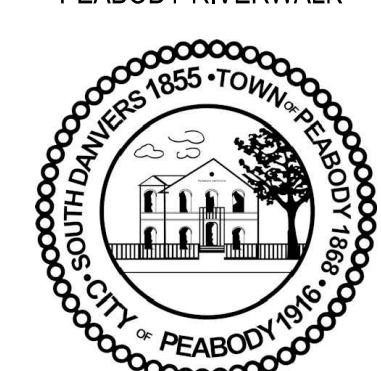

RIVERWALK PARK DESIGN PLANS  
CALLER STREET - HOWLEY STREET  
PEABODY, MA. 01960

**Weston & Sampson**  
WESTON & SAMPSON ENGINEERS, INC.  
85 DEVONSHIRE STREET, 3RD FLOOR  
BOSTON, MA 02109  
617-412-4480  
www.westonandsampson.com

Consultants:

Revisions:

No.	Date	Description

Seal:

Issued For:  
**75% DESIGN PLANS**

Scale: 1" = 20'  
Date: 03/11/2021  
Drawn By: HLB  
Reviewed By: SYC  
Approved By: SRB

W&S Project No.: ENG20-0145  
W&S File No.:

Drawing Title:  
**PROPOSED LAYOUT PLAN II**

Sheet Number:  
**S201**

P:\Peabody Riverwalk\AutoCAD\2020\2020-0145\Drawings\S201.dwg



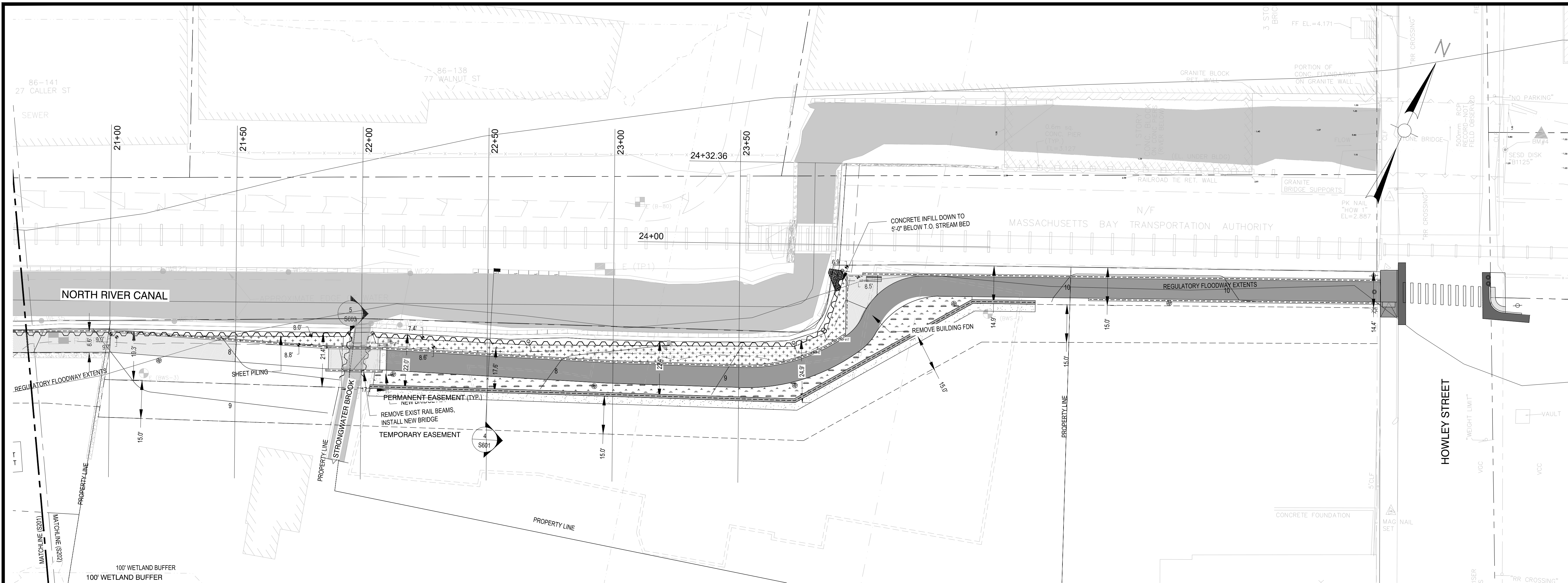

PLAN  
SCALE: 1" = 20'-0"

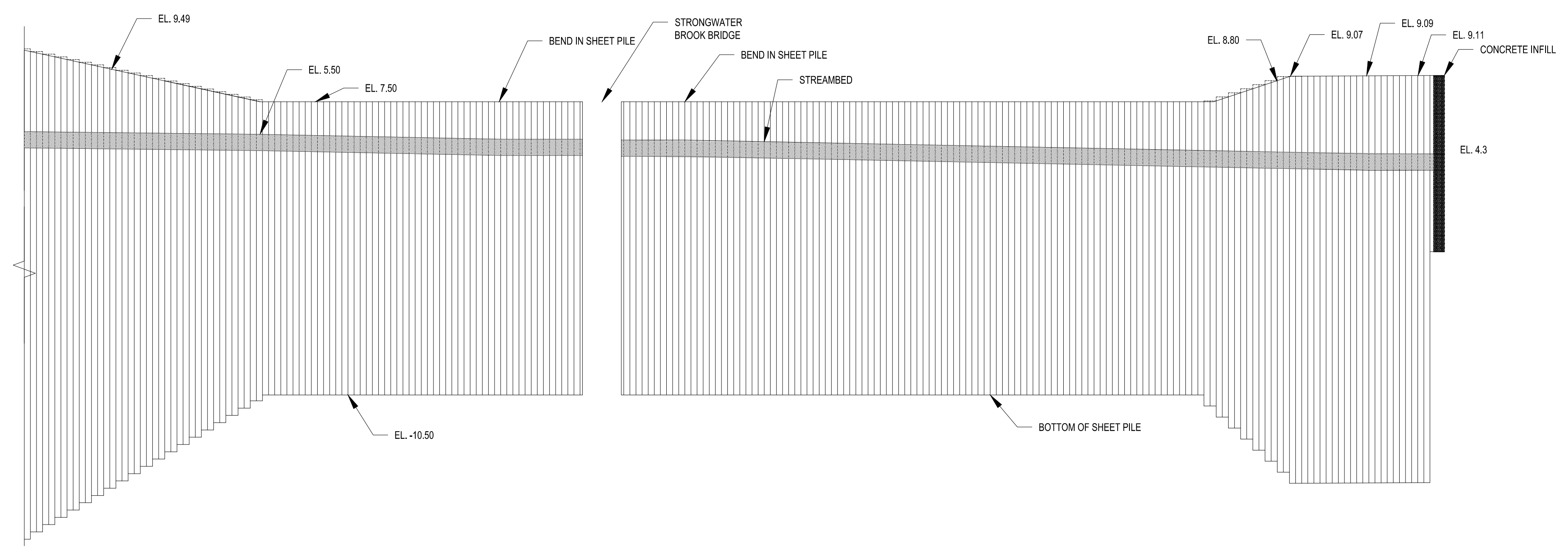

ELEVATION - SHEET PILE WALL  
HORIZONTAL SCALE: 1" = 20'  
VERTICAL SCALE: 1" = 1'

WORKING POINT TABLE		
WP #	NORTHING	EASTING
13	3120173.1015	-159559.3888
14	3120172.8502	-159550.1588
15	3120168.9470	-159488.2683
16	3120167.2228	-159382.9704
17	3120172.3121	-159371.1687
18	3120195.6586	-159363.2979

Project:  
**PEABODY RIVERWALK**

RIVERWALK PARK DESIGN PLANS  
CALLER STREET - HOWLEY STREET  
PEABODY, MA. 01960

**Weston & Sampson**  
WESTON & SAMPSON ENGINEERS, INC.  
85 DEVONSHIRE STREET, 3RD FLOOR  
BOSTON, MA 02109  
617-412-4480  
www.westonandsampson.com

Consultants:

Revisions:

No.	Date	Description

Seal:

Issued For:  
**75% DESIGN PLANS**

Scale: 1" = 20'  
Date: 03/11/2021  
Drawn By: HLB  
Reviewed By: SYC  
Approved By: SRB

W&S Project No.: ENG20-0145  
W&S File No.:

Drawing Title:  
**PROPOSED LAYOUT  
PLAN III**

Sheet Number:  
**S202**





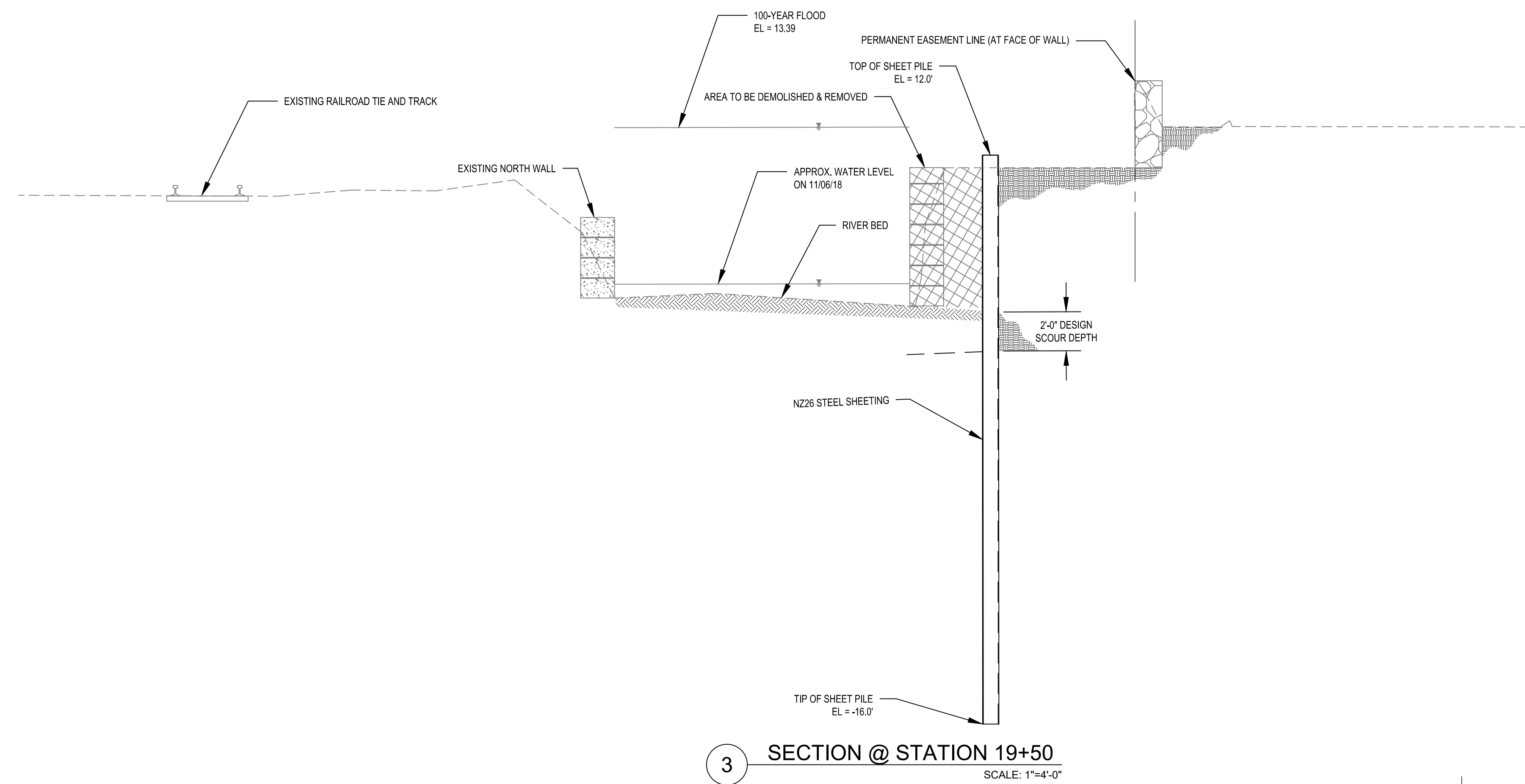

3 SECTION @ STATION 19+50  
SCALE: 1"=4'-0"

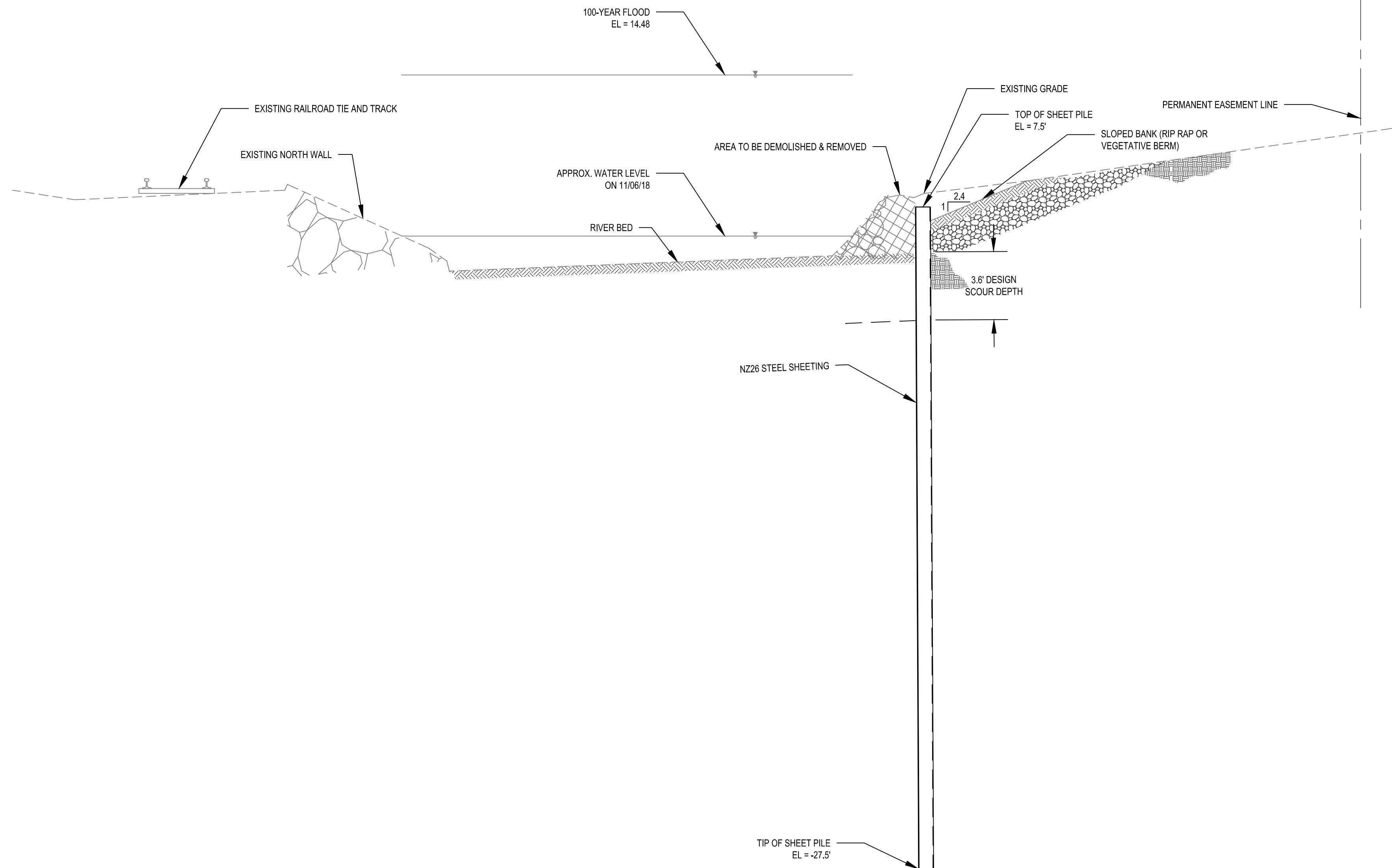

4 SECTION @ STATION 22+50  
SCALE: 1"=4'-0"

Consultants:

Revisions:

No.	Date	Description

Seal:

Issued For:  
**75% DESIGN PLANS**

Scale: AS NOTED  
Date: 03/11/2021  
Drawn By: HLB  
Reviewed By: SYC  
Approved By: SRB

W&S Project No.: ENG20-0145  
W&S File No.:

Drawing Title:  
**WALL SECTIONS AND DETAILS II**

Sheet Number:  
**S601**



Consultants:

Revisions:

No.	Date	Description

Seal:

Issued For:  
**75% DESIGN PLANS**

Scale: 1" = 20'

Date: 03/11/2021  
Drawn By: HLB  
Reviewed By: SYC  
Approved By: SRB

W&S Project No.: ENG20-0145  
W&S File No.:

Drawing Title:  
**OVERLOOK FRAMING  
PLAN, SECTIONS, &  
DETAILS**

Sheet Number:  
**S602**

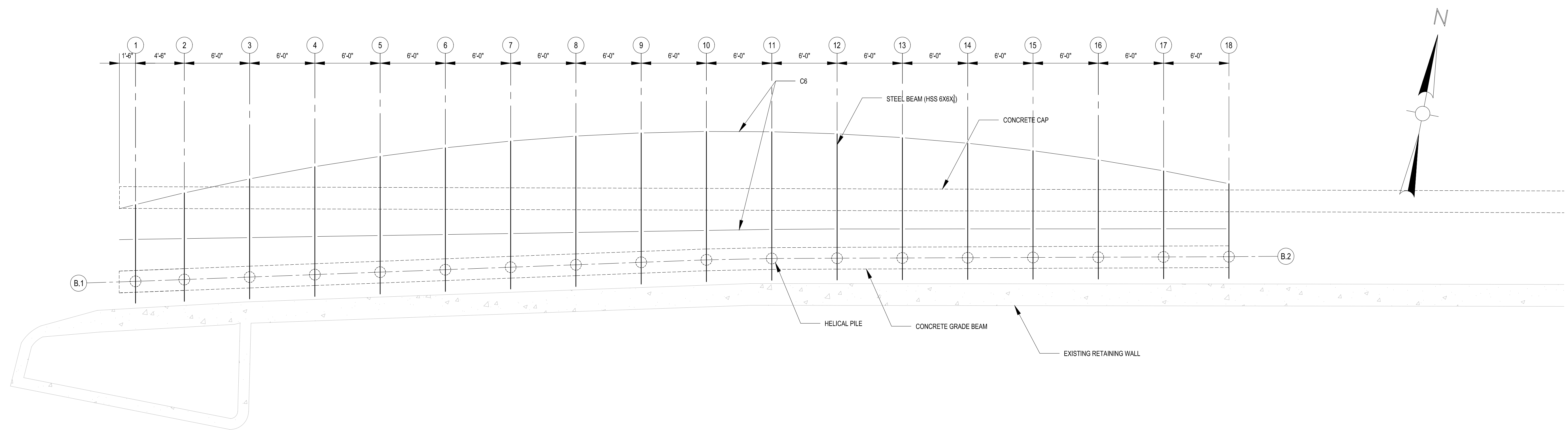

**FRAMING PLAN**  
SCALE: 1" = 5'-0"

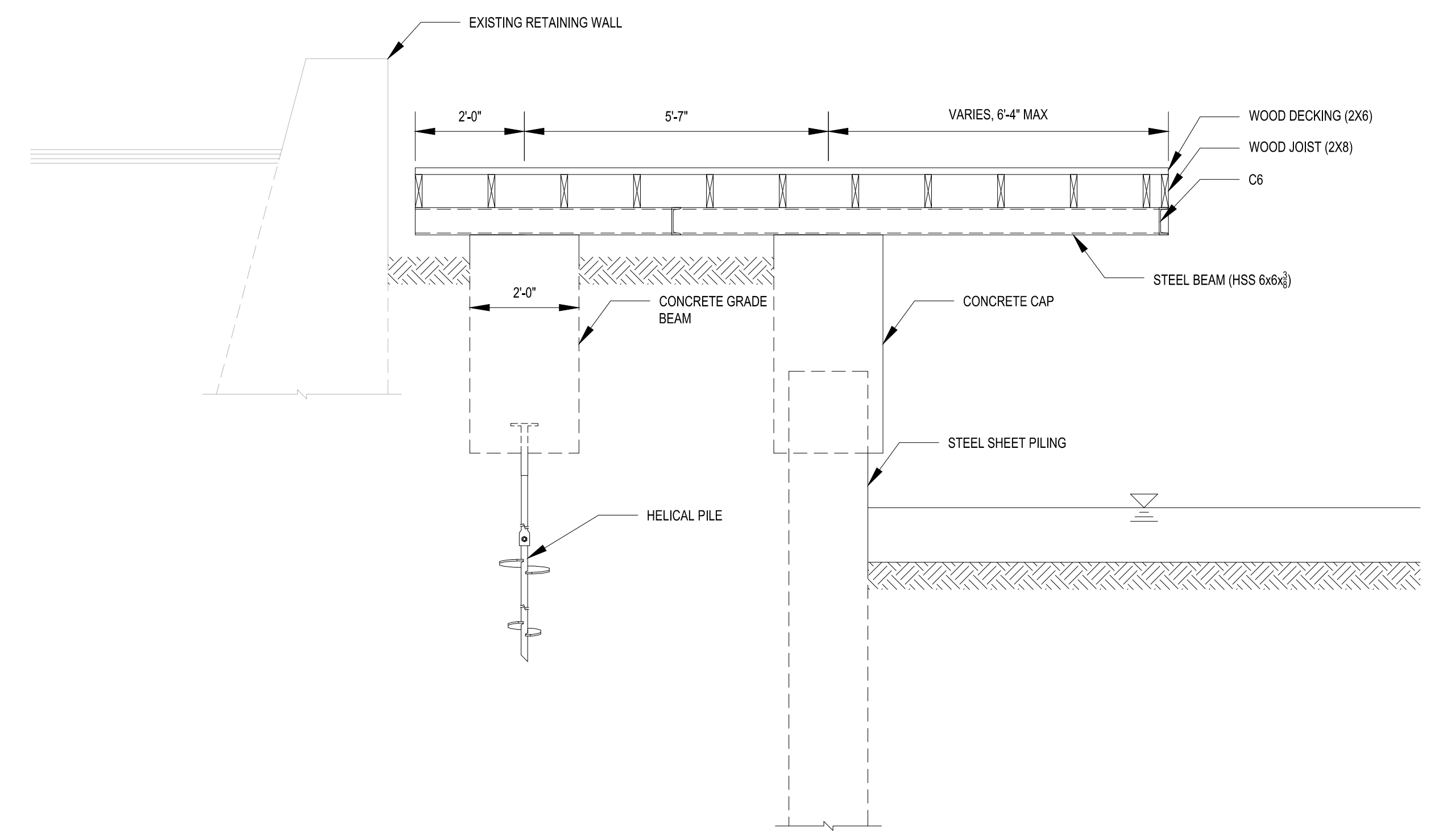

**ELEVATION VIEW**  
SCALE: 1/2" = 1'-0"

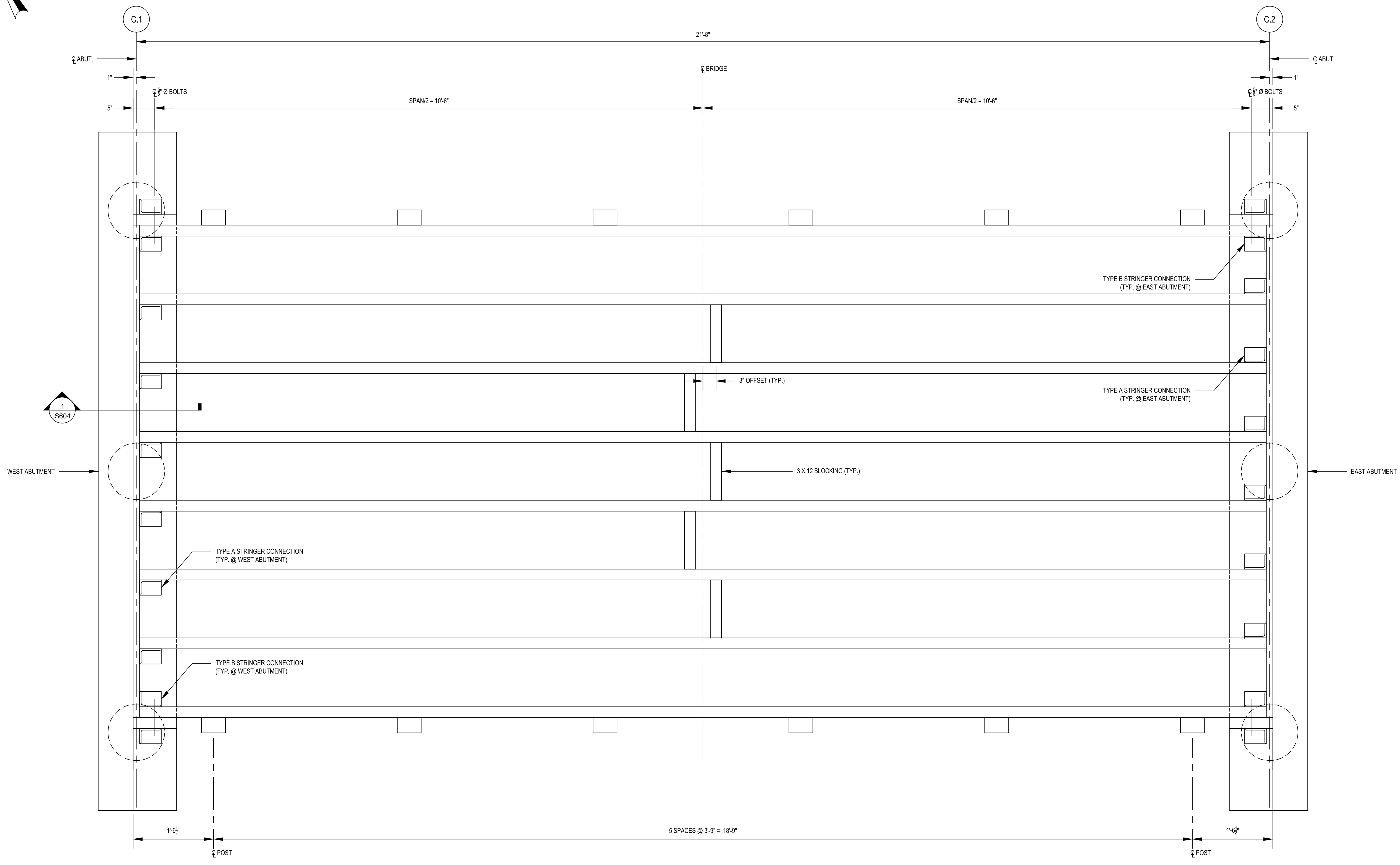
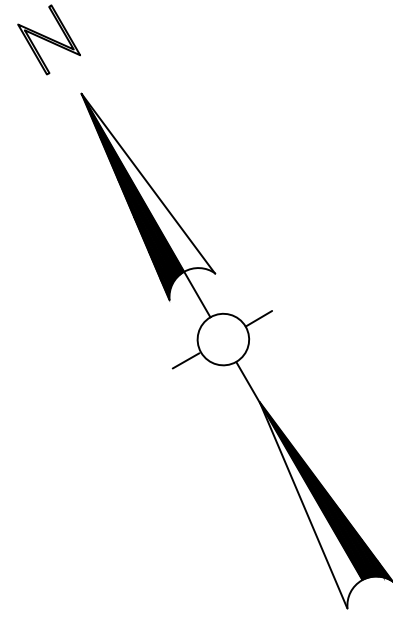

NOTE: RAILING POST ATTACHMENTS ARE NOT SHOWN FOR CLARITY.

**TIMBER BRIDGE FRAMING PLAN**  
SCALE: 1" = 1'-0"

Consultants:

Revisions:

No.	Date	Description

Seal:

Issued For:

**75% DESIGN PLANS**

Scale: AS NOTED  
Date: 03/11/2021  
Drawn By: HLB  
Reviewed By: SYC  
Approved By: SRB

W&S Project No.: ENG20-0145  
W&S File No.:

Drawing Title:  
**TIMBER BRIDGE PLAN & TYP. SECTION**

Sheet Number:  
**S603**

P:\Projects\2020\0145\020-0145-000-000-000-000.dwg

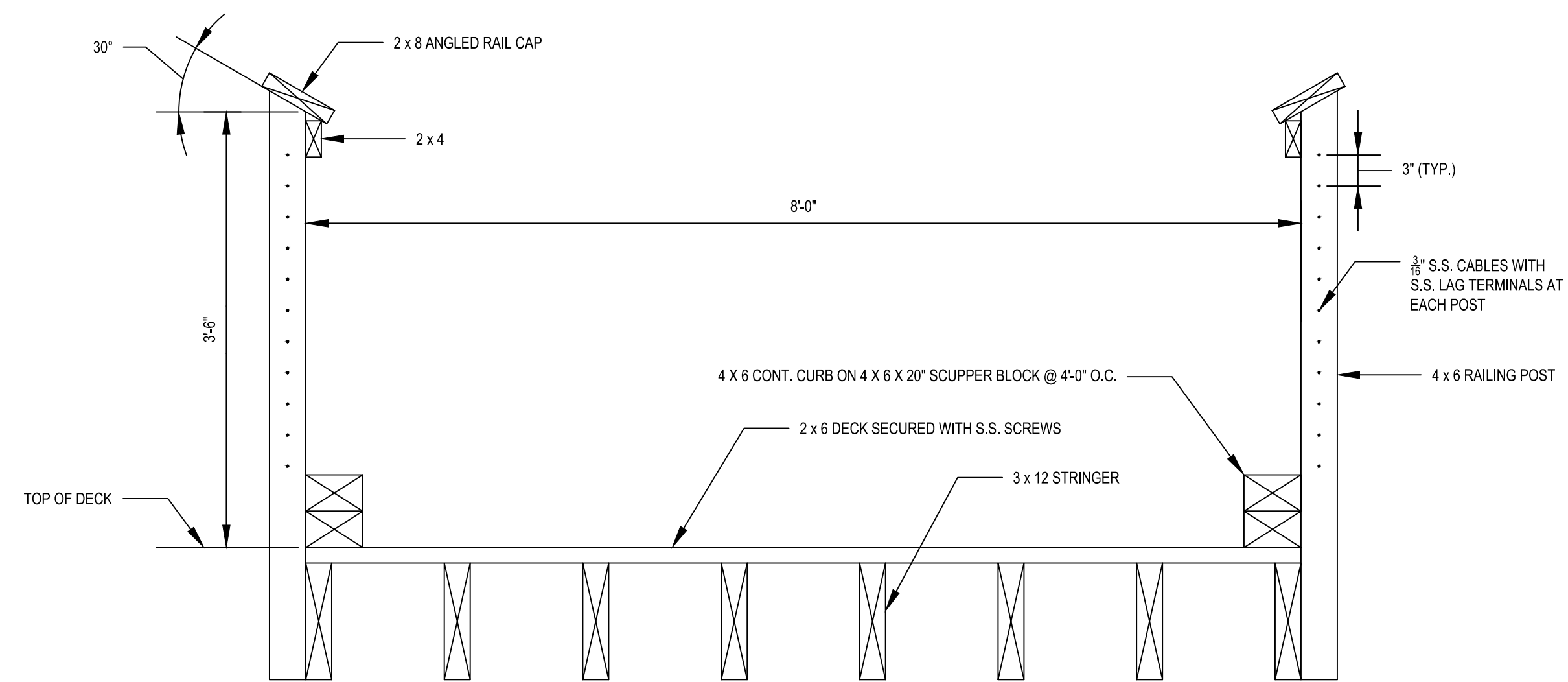

TYP. TIMBER BRIDGE SECTION  
SCALE: 1" = 1'-0"

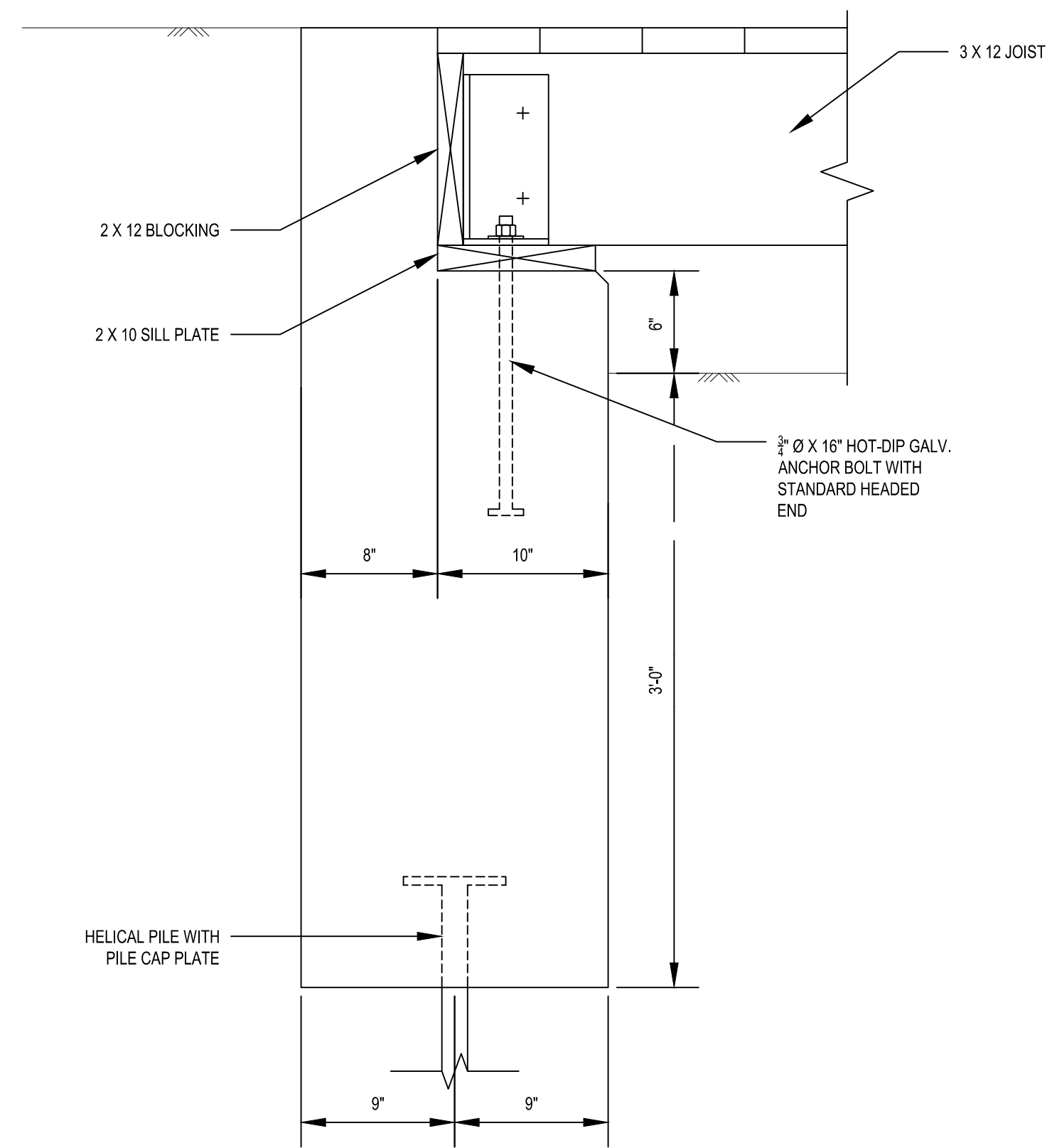

TYP. ABUTMENT SECTION 1  
SCALE: 1 1/8" = 1'-0" S603

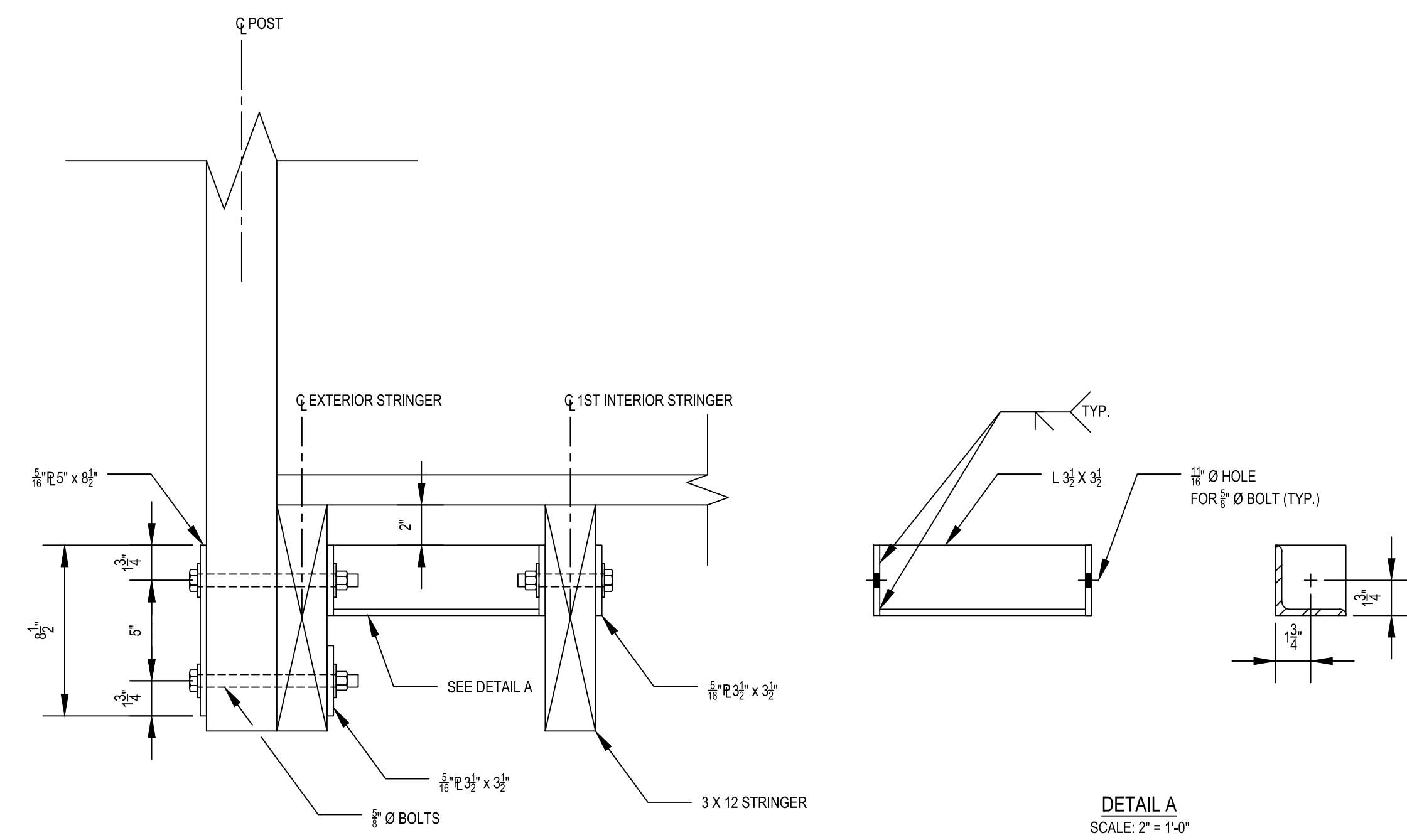

TYP. RAILING POST ATTACHMENT  
SCALE: 2" = 1'-0"

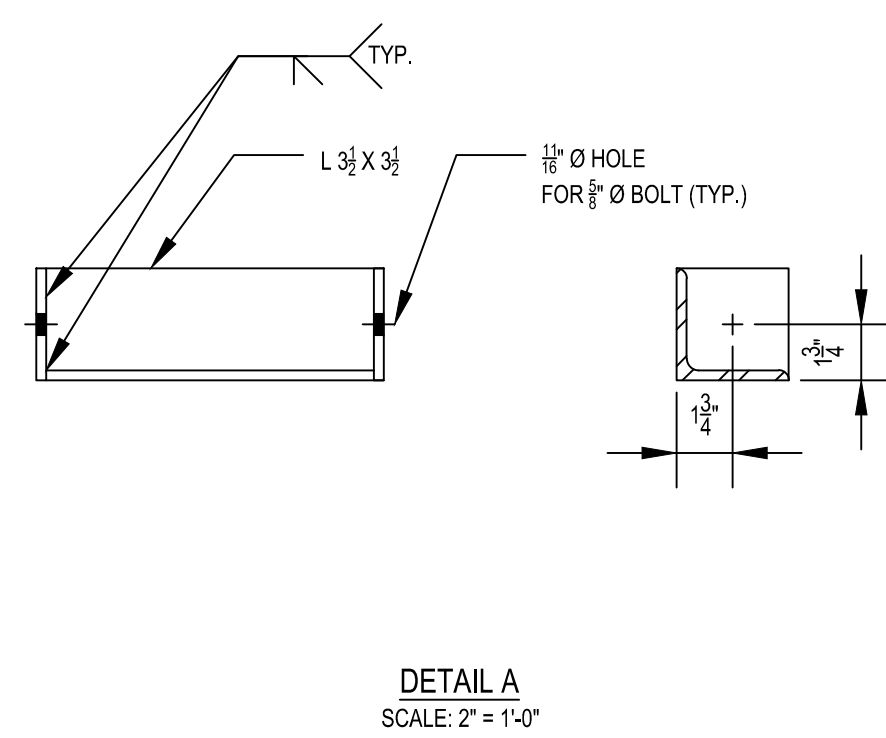

DETAIL A  
SCALE: 2" = 1'-0"

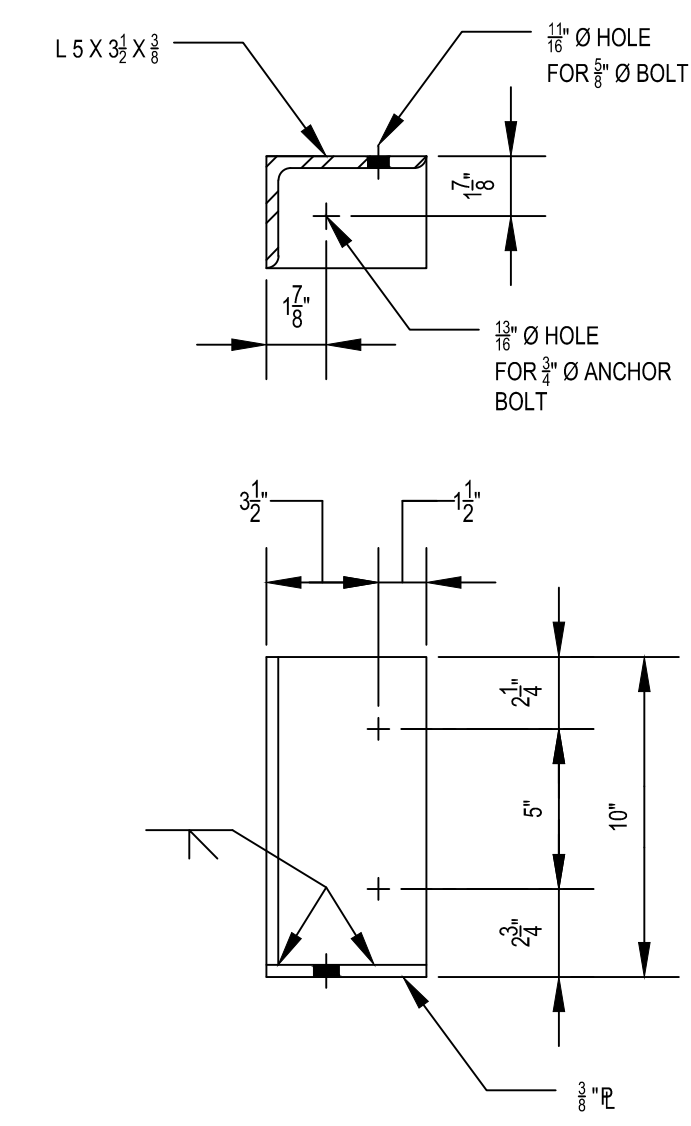

TYP. STRINGER CONNECTION DETAILS  
SCALE: 2" = 1'-0"  
TYPE A (AS SHOWN) TOTAL REQ'D = 16  
TYPE B (SIMILAR) TOTAL REQ'D = 4

Consultants:

Revisions:

No.	Date	Description

Seal:

Issued For:

75% DESIGN PLANS

Scale: AS NOTED  
Date: 03/11/2021  
Drawn By: HLB  
Reviewed By: SYC  
Approved By: SRB  
W&S Project No.: ENG20-0145  
W&S File No.:

Drawing Title:

TIMBER BRIDGE DETAILS

Sheet Number:

S604



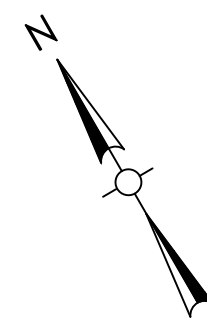

Project:  
PEABODY RIVERWALK

RIVERWALK PARK DESIGN PLANS  
CALLER STREET - HOWLEY STREET  
PEABODY, MA. 01960

**Weston & Sampson**  
WESTON & SAMPSON ENGINEERS, INC.  
85 DEVONSHIRE STREET, 3RD FLOOR  
BOSTON, MA 02109  
617-412-4480  
www.westonandsampson.com

Consultants:

Revisions:

No.	Date	Description

Seal:

Issued For:  
**75% DESIGN PLANS**

Scale: AS NOTED  
Date: 03/11/2021  
Drawn By: HLB  
Reviewed By: SYC  
Approved By: SRB  
W&S Project No.: ENG20-0145  
W&S File No.:

Drawing Title:  
**BOARDWALK PLAN & ELEVATION**

Sheet Number:  
**S605**

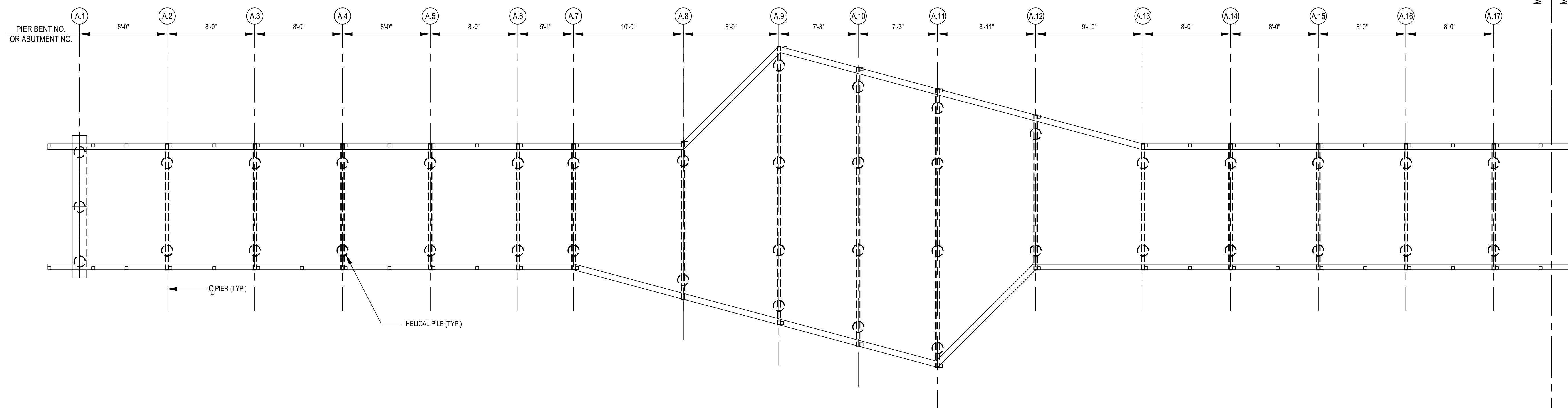

**BOARDWALK PLAN**  
SCALE: 1" = 5'-0"

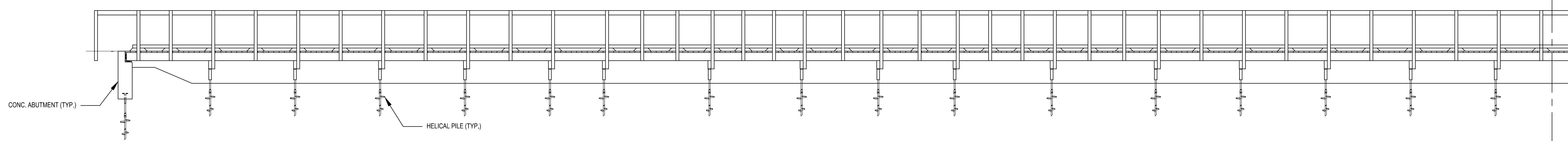

**BOARDWALK ELEVATION**  
SCALE: 1" = 5'-0"

P:\Projects\2020\0145\ENG\20-0145-01.dwg, 3/11/2021, 10:58:00 AM



Consultants:

Revisions:

No.	Date	Description

Seal:

Issued For:

**75% DESIGN PLANS**

Scale: AS NOTED  
 Date: 03/11/2021  
 Drawn By: HLB  
 Reviewed By: SYC  
 Approved By: SRB

W&S Project No.: ENG20-0145  
 W&S File No.:

Drawing Title:  
**BOARDWALK TYP. SECTIONS**

Sheet Number:  
**S607**

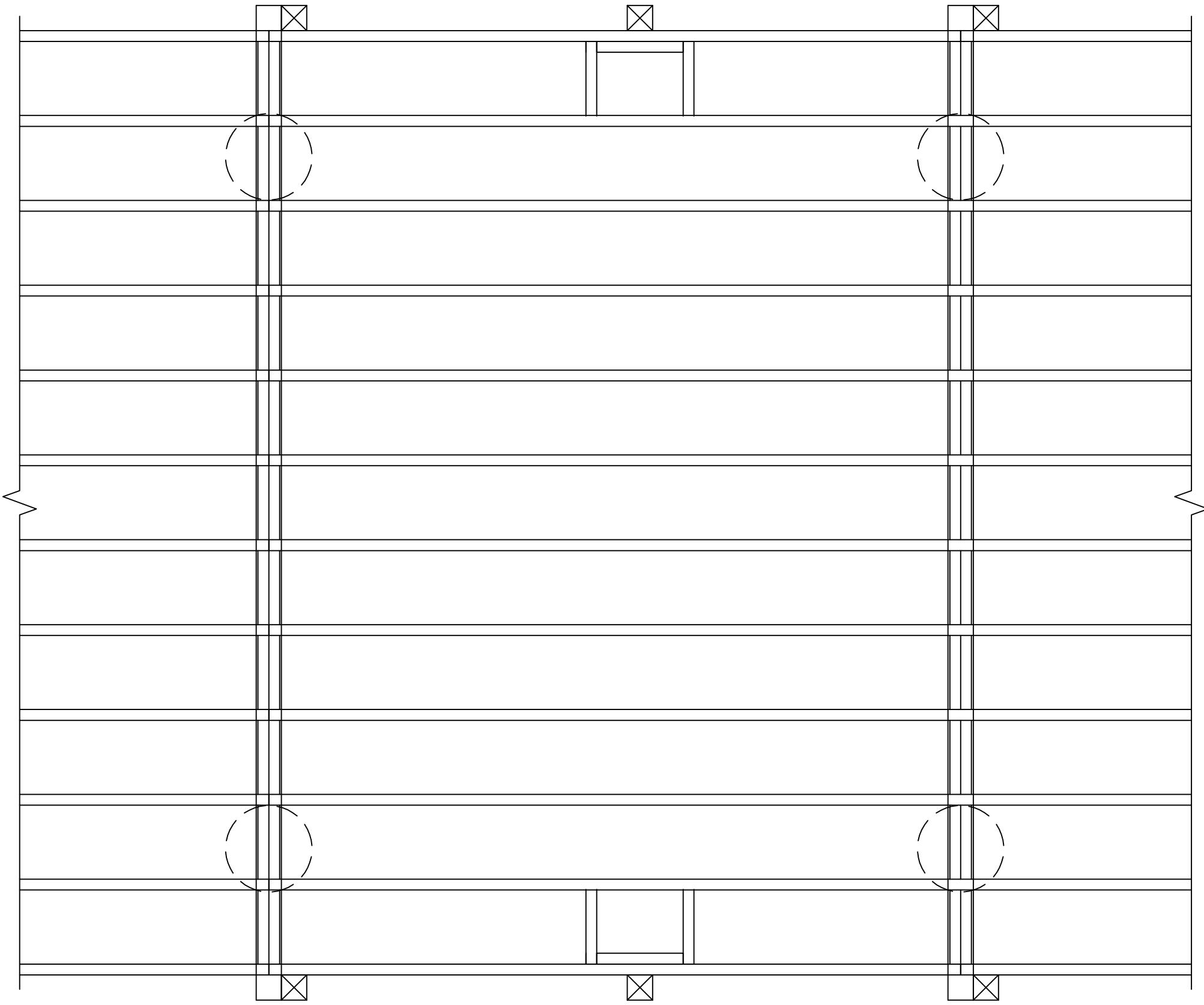

**TYP. BOARDWALK FRAMING PLAN**  
 SCALE: 3/4" = 1'-0"

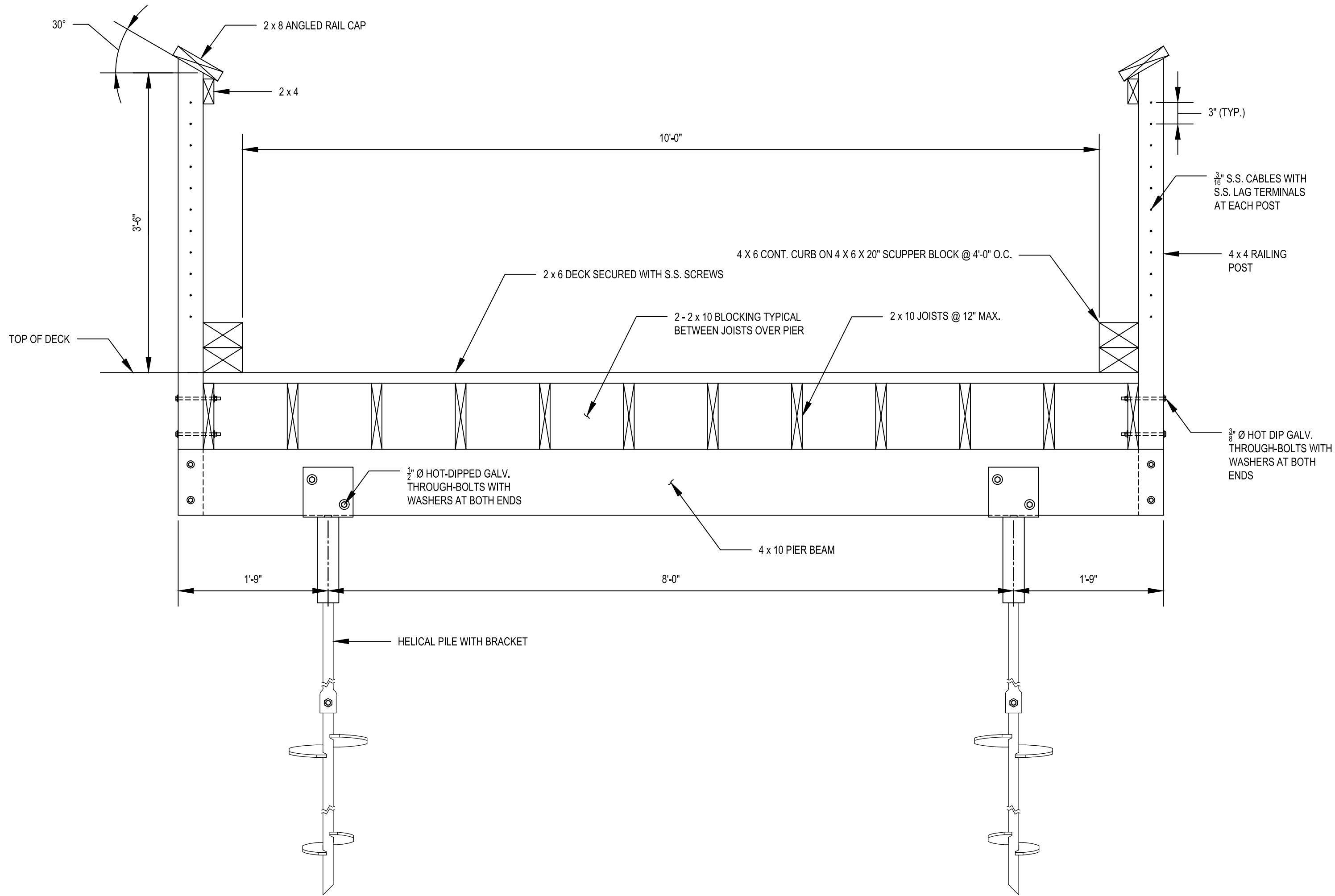

**TYP. BOARDWALK SECTION**  
 SCALE: 1" = 1'-0"

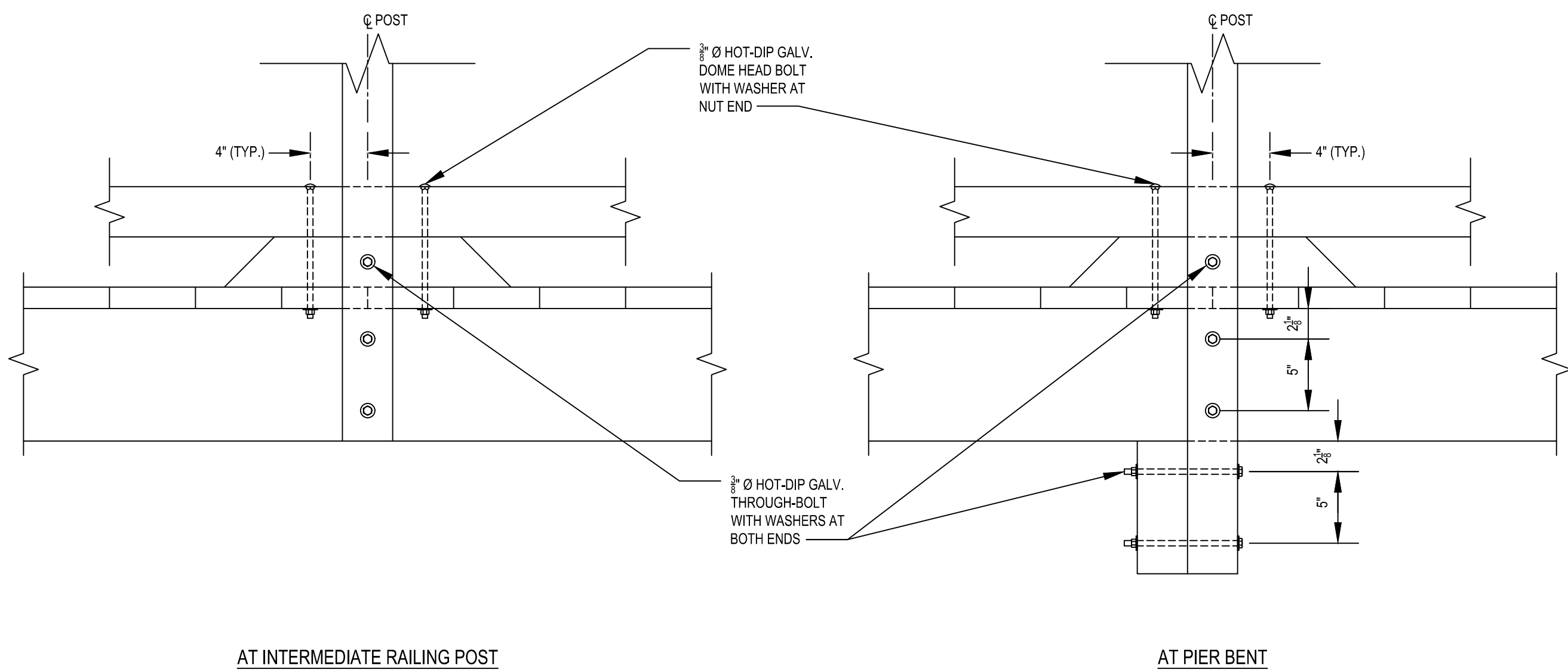

**TYP. RAILING POST & CURB ATTACHMENT**  
 SCALE: 1 1/2" = 1'-0"

P:\Projects\2020\03\11\2021\03112021\03112021\03112021.dwg  
 3/11/2021 10:48:10 AM  
 HLB





Consultants:

Revisions:

No.	Date	Description

Seal:

Issued For:

**75% DESIGN PLANS**

Scale: AS NOTED

Date: 03/11/2021

Drawn By: HLB

Reviewed By: SYC

Approved By: SRB

W&S Project No.: ENG20-0145

W&S File No.:

Drawing Title:

**BOARDWALK  
ABUTMENT TYP.  
SECTIONS**

Sheet Number:

**S608**

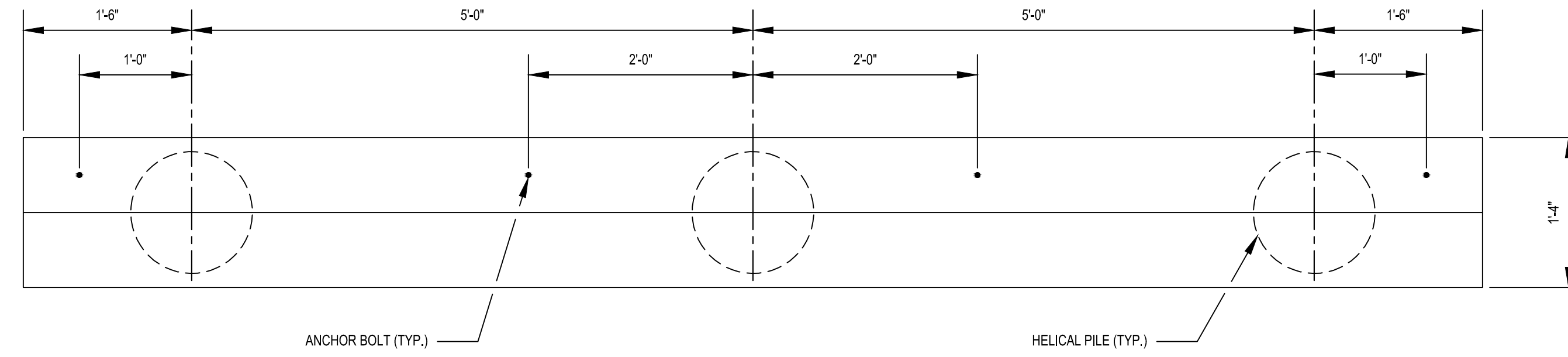

**TYP. ABUTMENT PLAN**  
SCALE: 1" = 1'-0"

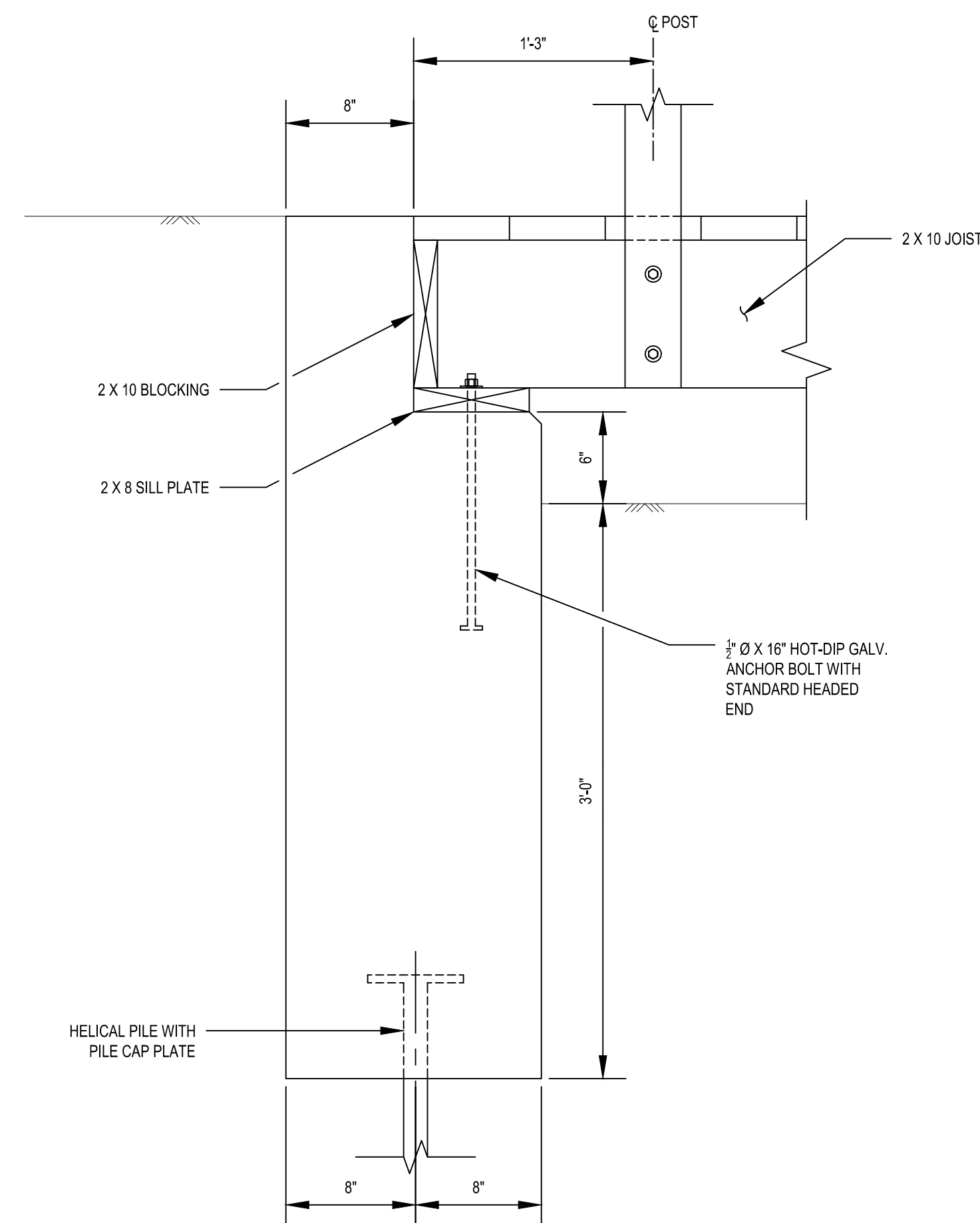

**TYP. ABUTMENT SECTION**  
SCALE: 1 1/2" = 1'-0"



Consultants:

Revisions:

No.	Date	Description

Seal:

Issued For:

**75% DESIGN PLANS**

Scale: NO SCALE

Date: 03/11/2021

Drawn By: HLB

Reviewed By: SYC

Approved By: SRB

W&S Project No.: ENG20-0145

W&S File No.:

Drawing Title:

**EROSION AND SEDIMENT CONTROL DETAILS**

Sheet Number:

**C601**

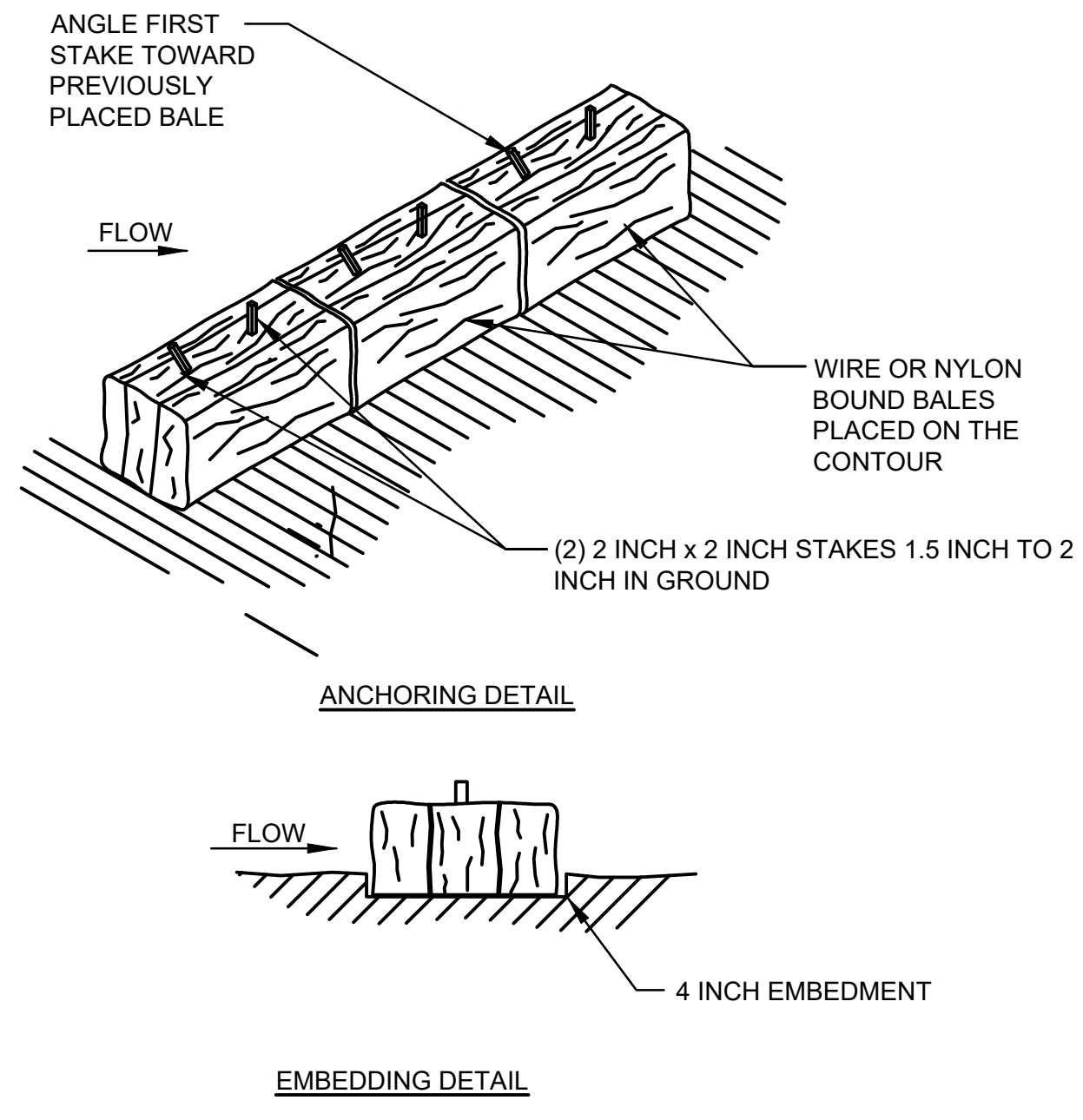

**3 STAKED HALE BALES- EROSION CONTROL**  
 SCALE: N.T.S.

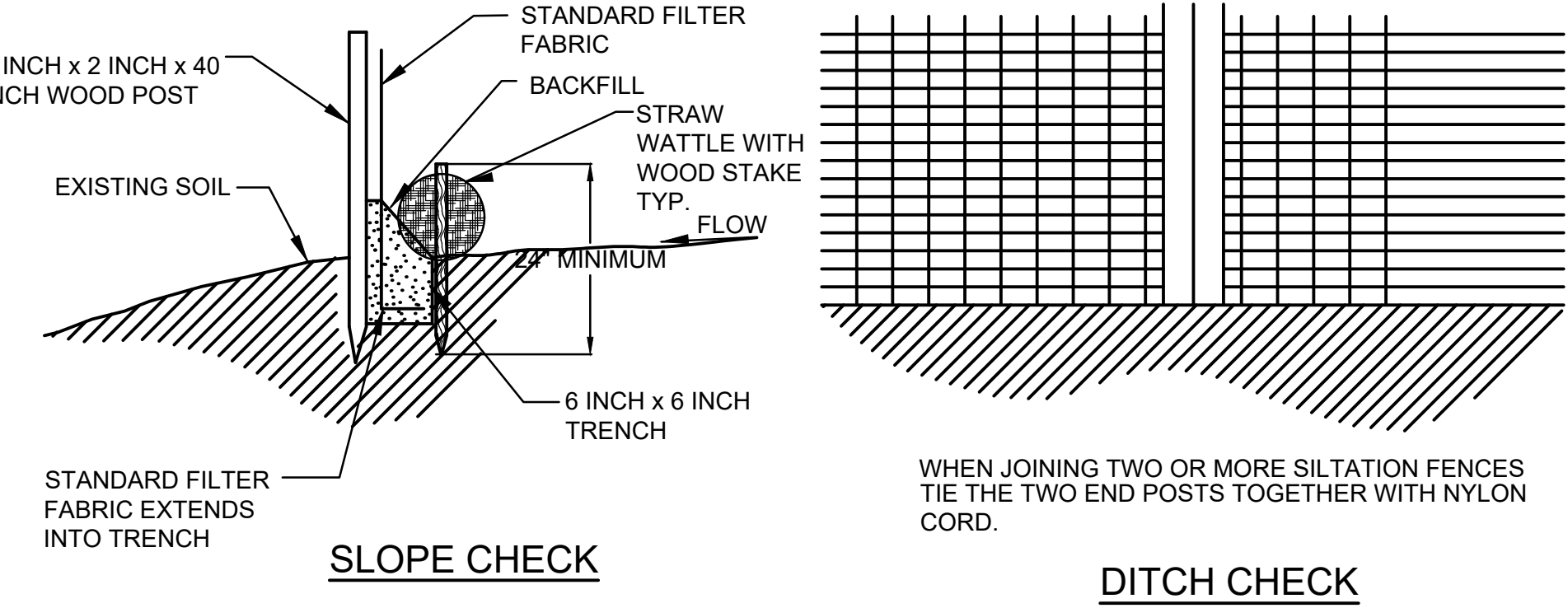

**4 SILT FENCE- EROSION CONTROL**  
 SCALE: N.T.S.

**GENERAL NOTES:**

- PROVIDE A MINIMUM TUBE DIAMETER OF 12 INCHES FOR SLOPES UP TO 50 FEET IN LENGTH WITH A SLOPE RATIO OF 3H:1V OR STEEPER. LONGER SLOPES OF 3H:1V MAY REQUIRE LARGER TUBE DIAMETER OR ADDITIONAL COURSING OF FILTER TUBES TO CREATE A FILTER BERM. REFER TO MANUFACTURER'S RECOMMENDATIONS FOR SITUATIONS WITH LONGER OR STEEPER SLOPES.
- INSTALL TUBES ALONG CONTOURS AND PERPENDICULAR TO SHEET OR CONCENTRATED FLOW.
- DO NOT INSTALL IN PERENNIAL, EPHEMERAL OR INTERMITTENT STREAMS.
- CONFIGURE TUBES AROUND EXISTING SITE FEATURES TO MINIMIZE SITE DISTURBANCE AND MAXIMIZE CAPTURE AREA OF STORMWATER RUN-OFF.
- MULCH MATERIAL FOR THE FILTER TUBES SHALL BE WEED-FREE STRAW, WOOD EXCELSIOR, COMPOST, OR WOOD CHIPS, OR COIR. STRAW SHALL BE WEED FREE AND DERIVED FROM THRESHING OF GRAIN CROP.
- CURVE ENDS UPHILL TO PREVENT DIVERSION OF UNFILTERED RUN-OFF.

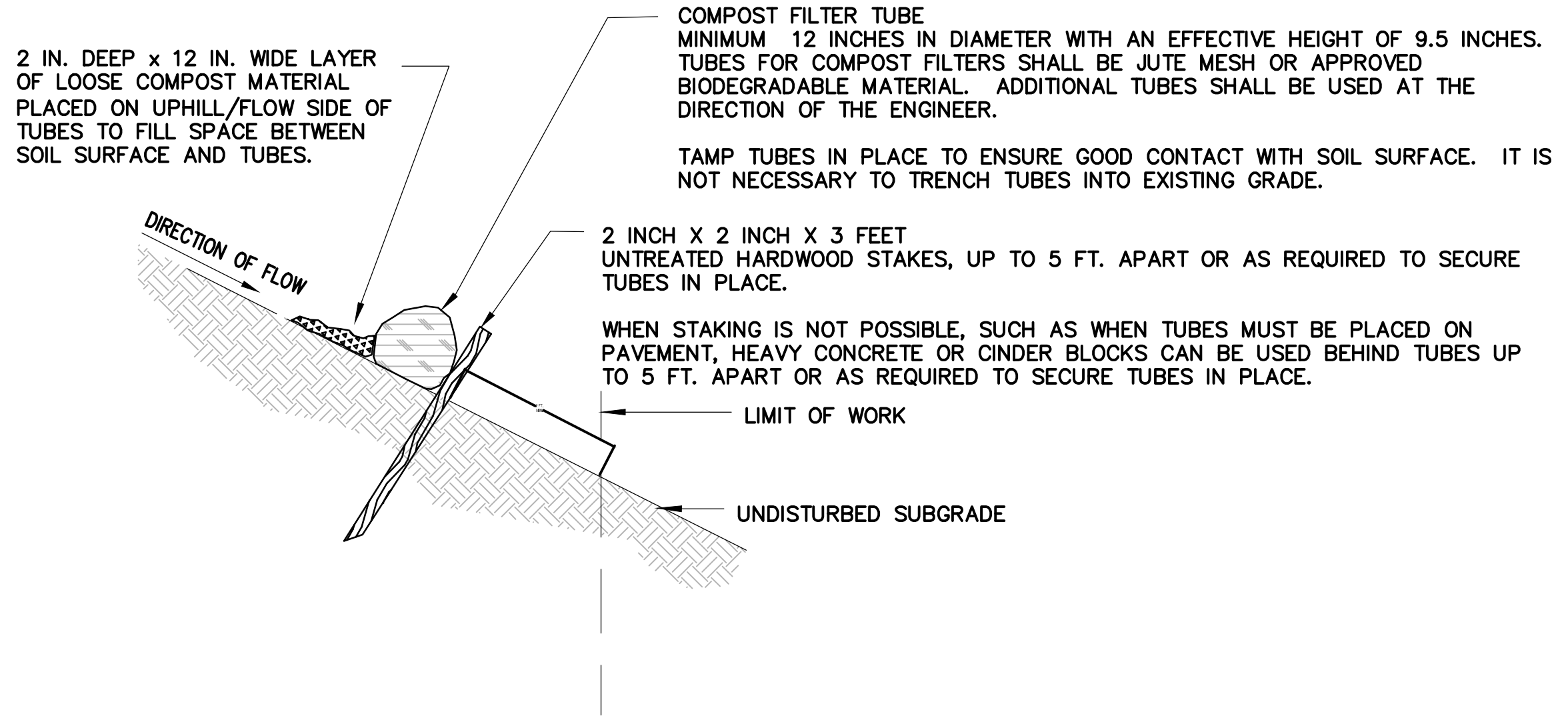

**3 SINGLE COMPOST FILTER TUBE DETAIL**  
 SCALE: N.T.S.

- EROSION CONTROL MEASURES SHALL BE INCORPORATED IN THE SEQUENCE OF CONSTRUCTION TO PREVENT SEDIMENT LADEN WATER FROM LEAVING THE SITE.
- AREAS SUBJECT TO EROSION SHALL BE MINIMIZED IN TERMS OF TIME AND AREA.
- IN GENERAL, WORK REQUIRING EROSION CONTROL INCLUDES EXCAVATIONS, FILLS, DRAINAGE, SWALES AND DITCHES, ROUGH AND FINISH GRADING, AND STOCKPILING OF EARTH.
- DO NOT DISTURB VEGETATION AND TOPSOIL BEYOND THE PROPOSED LIMIT OF SILT FENCE ACTIVITIES.
- TEMPORARY SILT CONTROLS SHALL BE PLACED AS SHOWN ON THE PLAN. PERMANENTLY STABILIZE EACH COMPLETED SEGMENT OF CONSTRUCTION.
- THE CONTRACTOR SHALL REMOVE TEMPORARY SILT CONTROLS AND ALL ACCUMULATED SILT AND DEBRIS AFTER COMPLETION OF CONSTRUCTION OPERATIONS.
- SILT CONTROLS SHALL BE IN PLACE AT ALL TIMES DURING CONSTRUCTION.
- THE CONTRACTOR SHALL REMOVE AND LEGALLY DISPOSE OF ALL SILT AND DEBRIS FROM EACH DRAINAGE STRUCTURE UPON COMPLETION OF THE PROJECT.
- OBJECTS AND/OR AREAS DAMAGED BY THE CONTRACTOR'S OPERATIONS SHALL BE RESTORED TO THEIR ORIGINAL CONDITION.
- ALL DISTURBED AREAS SHALL BE RESTORED TO EXISTING GRADE. INSPECTION SHALL BE FREQUENT AND REPAIR OR REPLACEMENT SHALL BE MADE AS NEEDED.
- SILT CONTROLS SHALL BE REMOVED UPON THE SATISFACTORY COMPLETION OF ALL WORK SO AS NOT TO BLOCK OR IMPEDE STORM FLOW OR DRAINAGE.
- SITE PERIMETER SHALL HAVE STRAW WATTLES INSTALLED AT THE LIMIT OF WORK.

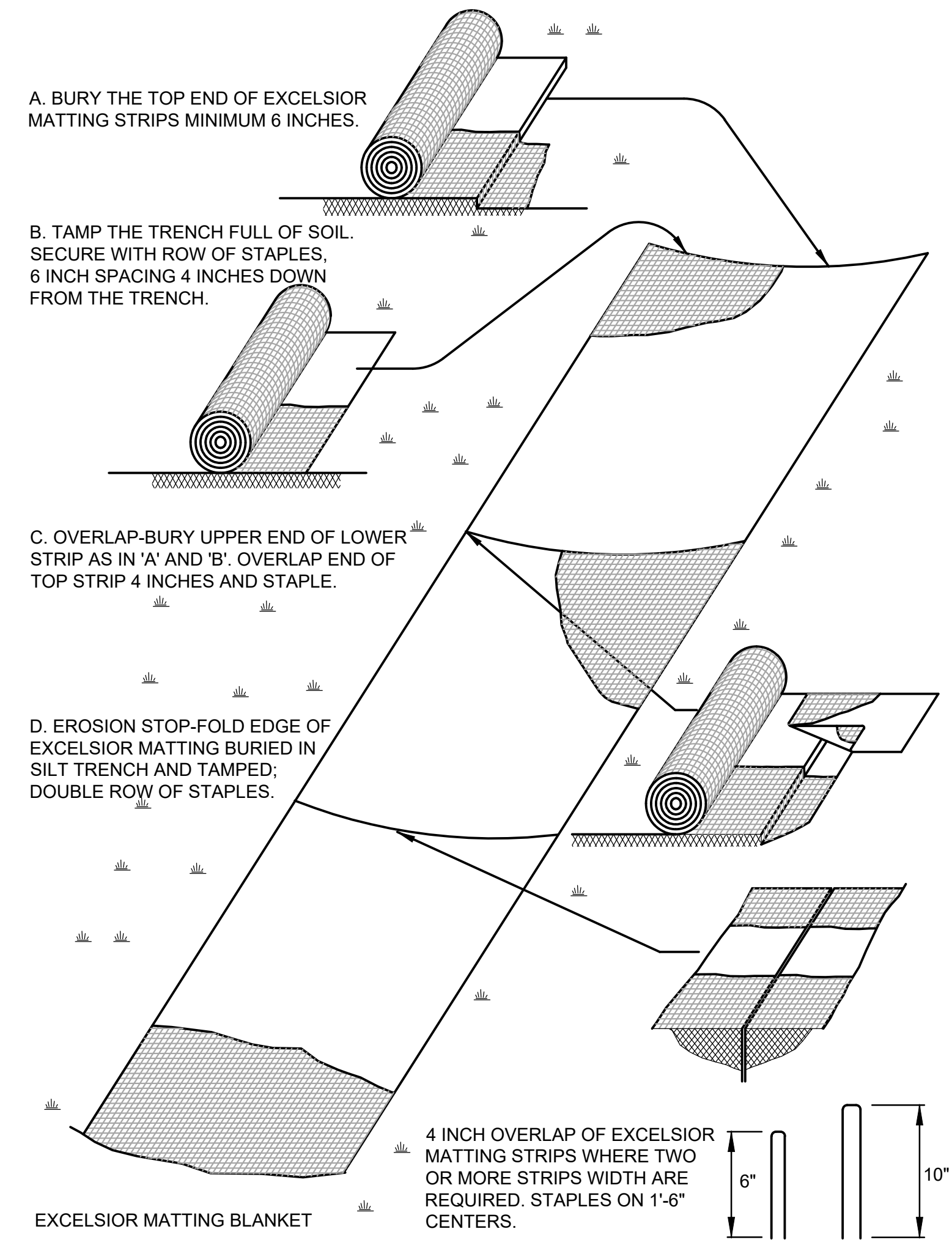

NOTE:  
 JUTE NETTING TO BE USED ON ALL SLOPES GREATER THAN 4H:1V AS INDICATED ON GRADING PLANS

**4 EROSION CONTROL BLANKET**  
 SCALE: N.T.S.

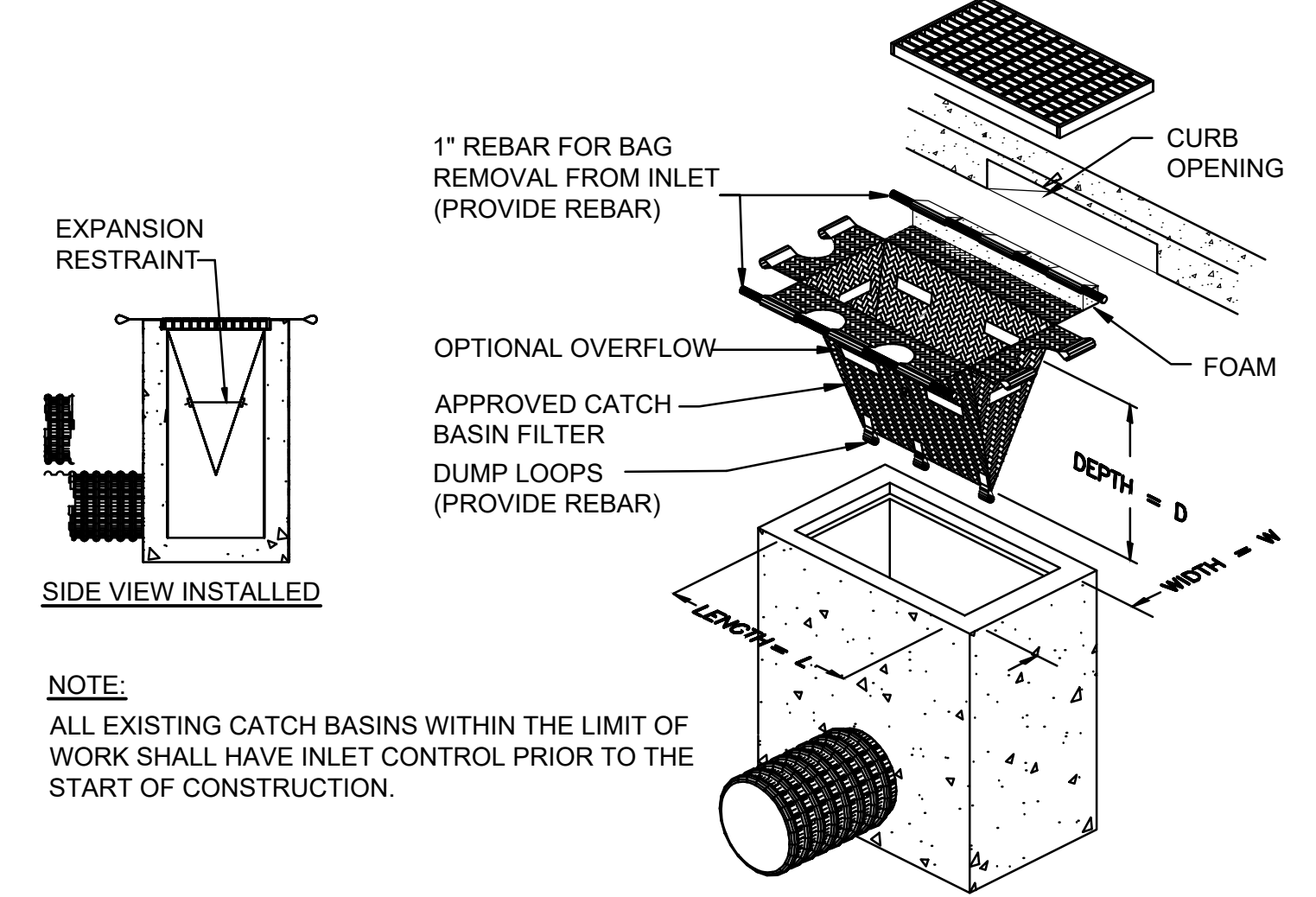

NOTE:  
 ALL EXISTING CATCH BASINS WITHIN THE LIMIT OF WORK SHALL HAVE INLET CONTROL PRIOR TO THE START OF CONSTRUCTION.

**1 INLET SEDIMENT CONTROL**  
 SCALE: N.T.S.

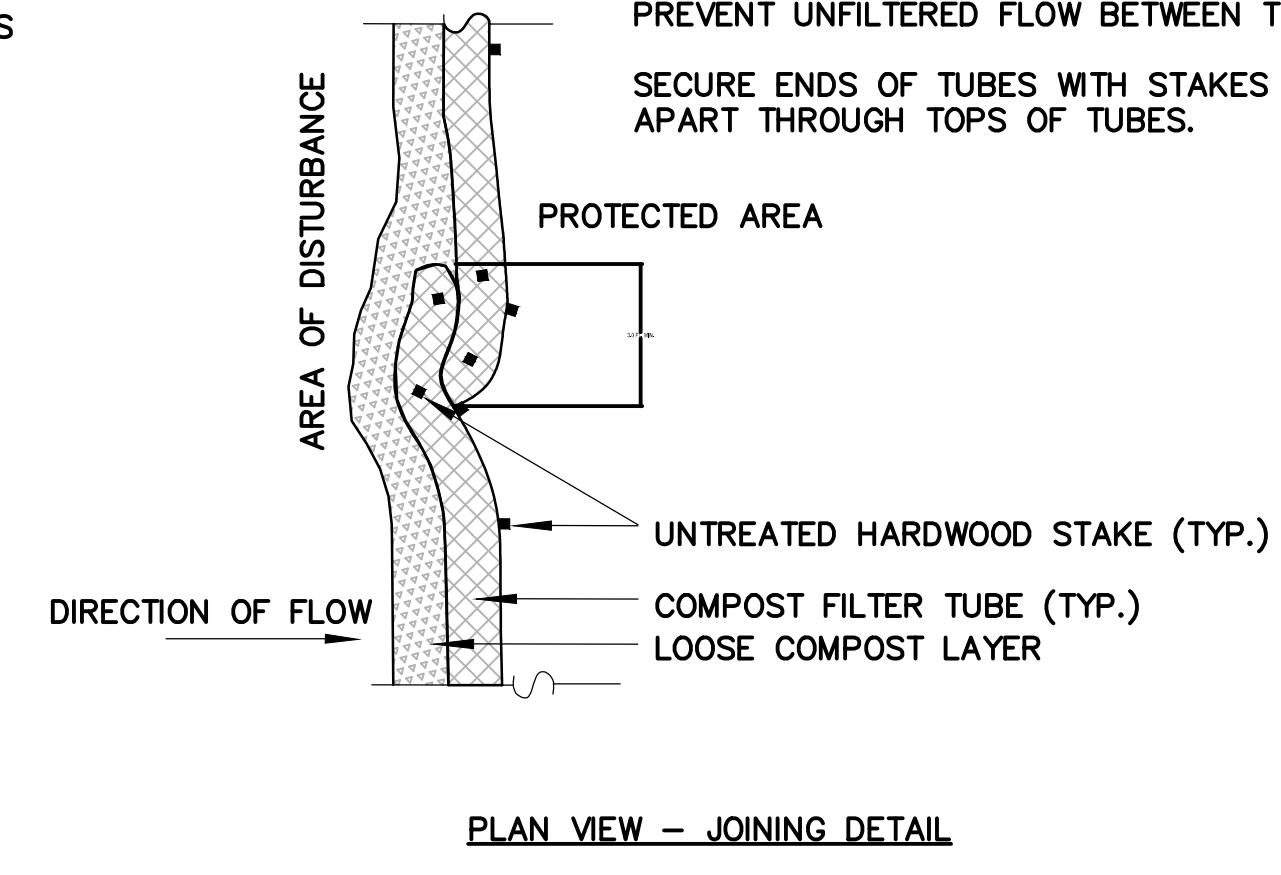

PLAN VIEW - JOINING DETAIL







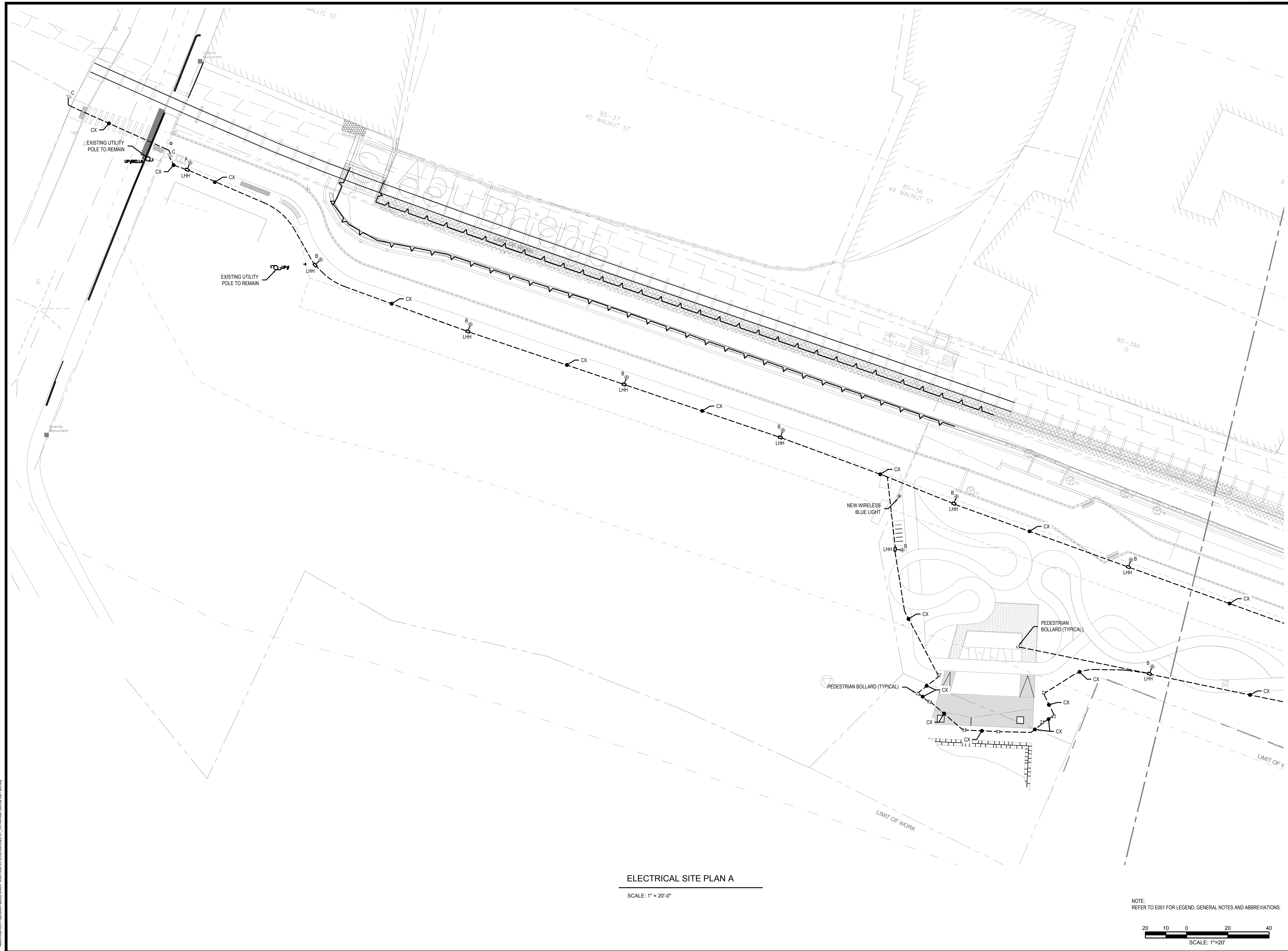

ELECTRICAL SITE PLAN A

SCALE: 1" = 20'-0"

NOTE:  
REFER TO E001 FOR LEGEND, GENERAL NOTES AND ABBREVIATIONS.

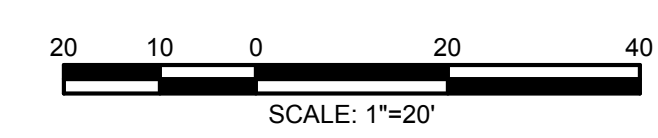

Project:  
PEABODY RIVERWALK  
RIVERWALK PARK

WALLIS STREET -  
CALLER STREET -  
HOWLEY STREET  
PEABODY, MA. 01960

**Weston & Sampson**  
WESTON & SAMPSON ENGINEERS, INC.  
85 DEVONSHIRE STREET, 3RD FLOOR  
BOSTON, MA 02109  
617-412-4480  
www.westonandsampson.com

Consultants:

Revisions:

No.	Date	Description

Seal:

Key Plan:

Issued For:  
**75% DESIGN DEVELOPMENT  
- NOT FOR CONSTRUCTION -**

Scale: AS NOTED  
Date: MARCH 2021  
Drawn By: FN  
Reviewed By: DNM  
Approved By: RFM

W&S Project No.: ENG20-0145  
W&S File No.:

Drawing Title:  
**ELECTRICAL  
SITE PLAN A**

Sheet Number:  
**E101**



















**APPENDIX G**

MCP Strategy & Considerations Memo – June 2020

# MEMORANDUM

**TO:** Brendan Callahan (City of Peabody)

**FROM:** Sarah DeStefano and George Naslas PG, LSP (Weston & Sampson)

**DATE:** June 2, 2021

**SUBJECT:** Executive Summary for MCP Strategy and Considerations  
FY20-21 MVP Action Grant - Peabody North River Canal Resilient Wall and Riverwalk and Park – Phase II

---

This memorandum summarizes the activities and conclusions related to the Massachusetts Contingency Plan (MCP) strategy and considerations for construction and compliance for the Peabody North River Canal Resilient Wall, Riverwalk, and Park (the Project). This memorandum is submitted in accordance with Task 4 of our February 19, 2020 Proposal. Weston & Sampson's environmental staff coordinated with the design and permitting team and has prepared this memorandum to document:

- The current regulatory status under the MCP
- Implications of contamination on permitting, design, and construction
- Estimation of soil volumes and disposal options based on the 75% design, and
- Updated preliminary cost estimates based on the 75% design for the Project.

## **Project Understanding and Background**

In 2020, the City of Peabody (the City) obtained additional Municipal Vulnerability Preparedness (MVP) funding to further develop and permit the preliminary design concepts for the Project (Phase II). Specifically, the purpose of Phase II was to bring the preliminary design to 75% design. Weston & Sampson's scope included, in addition to MCP Considerations, architectural and engineering design for the Project; structural, geotechnical, and stormwater engineering sub-tasks; the generation of associated permitting submittals; resiliency evaluation; community engagement activities; and assistance with project and grant management.

## **Project Area Description**

The Project Area includes the six parcels that abut the south side of the North River Canal, located between Wallis Street and Howley Street in Peabody, Massachusetts. Note that in this reach the North River has been channelized and is known as the North River Canal.



Historically, the area south of the North River Canal was developed to support the leather industry beginning in the 1700s. Previous uses of the six parcels include tanneries, chemical companies, machine shops, a foundry, and various tannery support operations, most of which had ceased operations by the middle of the 20th century.

Five of the six parcels have a history of releases of oil and/or hazardous materials (OHM) under the MCP. Additionally, the area between Howley Street and Caller street was the location of a large fire in the early 1980s that destroyed what remained of the former tannery complexes.

The primary contaminants of concern are related to fill material that includes industrial by-products (coal, coal and wood ash, tannery scraps, & building materials). Fill materials appear to be present throughout the Project Area to an expected depth of 8-10 feet. Those contaminants of concern are primarily arsenic, chromium, lead, and PAHs/SVOCs. Some sites also have a history of PCBs and petroleum-related impacts. A summary of soil conditions and MCP status at each parcel is presented below.

## **Previous Investigations and Release History**

### 13 Wallis Street

The property located at 13 Wallis Street is not listed as Disposal Site by MassDEP; however, it has a long, industrial history primarily in tannery operations. Currently, a US Post Office occupies the northwestern corner of the property and the remainder of the property is used to store miscellaneous construction equipment.

Subsurface investigations conducted in 2009 (by others) and 2017 (by Weston & Sampson) indicated the presence of fill material containing arsenic, chromium, lead, and PAHs at concentrations in equal to or exceeding the MassDEP Reportable Concentrations (RCs) for S-1 soil (RCS-1) at depths of 0-5 feet below ground surface (bgs). Several additional metals and PCBs were detected at concentrations below the applicable MassDEP RCS-1 thresholds in shallow soil and PAHs were also detected below the RCS-1 thresholds in deeper soil (5-10 feet below ground surface).

To date, the concentrations of arsenic, chromium, lead, and PAHs detected at/above the RCS-1 thresholds have not been reported to the MassDEP by the property owner.

### 24 Caller Street

The property located at 24 Caller Street has a documented history of environmental releases and is regulated under the MCP under Release Tracking Number (RTN) 3-18180. In 2000, the RTN was closed under the MCP with a Class A-3 Release Action Outcome (RAO) supported by an Activity and Use Limitation (AUL). The AUL restricted activity in an approximately 15,000 square foot area in the northwestern portion of the property. Uses which were likely to include the presence of a child (residential, daycare, park, etc.) were prohibited by the AUL. The AUL was invalidated when the property was transferred from the former owner (Clark Barrel) to the City in June 2019.

On November 6, 2019, MassDEP issued a Notice of Audit Findings (NOAF) for an AUL Audit Inspection to the City for an audit conducted in September 2019. The NOAF identified a violation, specifically that when the property was transferred, the AUL was not incorporated in full or by reference into the June 2019 deed, and a copy of the deed was not submitted to MassDEP. The corrective action identified by MassDEP was to terminate the existing AUL and submit a new AUL by the Interim Deadline of March 30, 2020.

Weston & Sampson, on behalf of the City, responded to MassDEP in the form of a letter requesting an extension of the Interim Deadline. Weston & Sampson described the on-going assessment activities being performed by the City and plans for redevelopment, and requested either a 6-month or 18-month extension of the Interim Deadline. After a telephone call with Mr. Peter Richards of MassDEP, it was agreed upon that the City would receive an extension of 18 months for the Interim Deadline to resubmit the AUL for the Site. The City will need to request another extension from MassDEP to accommodate the on-going work associated with the project, or terminate the existing AUL and submit a new AUL, prior to the September 2021 deadline.

Contaminants of concern included metals (lead, chromium, cadmium, and arsenic), PAHs and VOCs, and to a lesser extent polychlorinated biphenyls (PCBs). In addition, the file for RTN 3-18180 indicated that a historical 'landfill' was identified in the northeast portion of parcel. The nature of the landfilled materials is unknown.

Based on the history of the Site and the continued use as a drum reclamation facility, Weston & Sampson conducted several subsurface investigation events at 24 Caller Street from 2017 to 2020. The results of the subsurface investigations were summarized in a Letter Report in 2017 and Phase II Environmental Site Assessment (ESA) Report in July 2020.

The results of Weston & Sampson's 2017-2020 soil and groundwater investigations indicated that concentrations of metals, PCBs, petroleum constituents, and semi-volatile organic compounds (SVOCs) are present in soil above the applicable Method 1 S-1 Cleanup Standards. Lead and PCBs in soil are the primary contaminants of concern, and the highest concentrations are generally limited to the western portion of the Site (rear of the building). Additionally, Weston & Sampson identified an area of light non-aqueous phase liquid (LNAPL) beneath the former building foundation. Planning for additional sampling to further define the extent of the LNAPL and conduct additional targeted soil sampling is underway, and field work is expected to occur in the Summer of 2021.

### 21 Caller Street

The 21 Caller Street property has a documented history of releases to the environment and is regulated by MassDEP under RTN 3-0577. A Permanent Solution Statement (PSS) with Conditions was submitted for 21 Caller Street in May of 2014. The PSS relies on an AUL that restricts activities that involve the excavation, removal and/or disturbance of soils greater than 3 feet below the ground surface unless under the oversight of a Licensed Site Professional (LSP), and prohibits the use of the property to grow agricultural produce. The AUL is applicable to the entire parcel.



A review of historical MCP reports (by others) and an investigation conducted by Weston & Sampson in 2017, indicated contaminants of concern within the Project alignment on 21 Caller Street include arsenic and lead in soil exceeding the applicable Method 1 S-1 Cleanup Standards.

#### 18 Howley Street

The property located at 18 Howley Street has a documented history of environmental releases and is also regulated by MassDEP under RTN 3-0577. A Class B-2 RAO and AUL (i.e., a PSS with Conditions) was submitted for 18 Howley Street in 2013.

The AUL prohibits the use of the property as a residence, school, daycare, nursery recreational area (e.g., park or athletic field) and/or any other use in which a child's presence is likely. The AUL also restricts long-term (greater than 1 month) activities at the property that are likely to result in the excavation, relocation and/or removal of soils, unless such activity is first evaluated by an LSP. The AUL is applicable to the entire parcel.

A review of historical MCP reports (by others) and an investigation conducted by Weston & Sampson in 2017 indicate the primary contaminants of concern are antimony, arsenic, barium, trivalent chromium, lead, and PAHs in soil exceeding the applicable Method 1 Cleanup Standards.

#### 166R Main Street

The property located at 166R Main Street has a documented history of environmental releases and is regulated by MassDEP under RTNs 3-14440 and 3-4322.

RTN 3-4322 was closed under the MCP in 1997 with a Class A-2 RAO. A Class A-2 RAO is a Permanent Solution for which contamination has not been reduced to background concentrations, but does not rely on an AUL.

RTN 3-14440 was closed under the MCP in 2007 with a Class A-3 RAO and AUL [i.e. a Permanent Solution Statement with Conditions]. The AUL restricts the use of the property for single family residential use or for growing of produce for human consumption. The AUL also restricts activity at the property that is likely to cause physical or chemical deterioration, breakage, or damage to the pavement or building foundations, unless such activity is first evaluated by an LSP. The AUL is applicable to the entire parcel.

The primary contaminants of concern at the 166R Main Street property are metals (i.e., arsenic, chromium and lead), PAHs, and petroleum compounds. Historical fill has also been observed in the top 8 to 10 feet of soil. To date, Weston & Sampson has not been able to access 166R Main Street to collect soil samples within the Project alignment.

### 20 Howley Street

The property located at 20 Howley Street has a documented history of environmental releases and is regulated by MassDEP under RTN 3-17492. The property was closed under a Class B-2 RAO, which relied on an AUL to restrict future use and development. The AUL is applicable to approximately 31,800 square feet in the northern portion of the 38,385-square foot total parcel area, which includes the Project Area.

Under the AUL, engineering controls such as bituminous pavement and building foundations must remain in good condition to prevent exposures to underlying impacted soils. Semi-annual inspections are required to confirm and document the condition of the engineering controls.

Based on a review of historical MCP reports and data collected by Weston & Sampson in 2017, the primary contaminants of concern at 20 Howley Street are arsenic, chromium, lead, PAHs, and petroleum impacts in soil exceeding the applicable Method 1 Cleanup Standard.

### **MCP/Soil Management Tasks**

As part of the internal coordination between Weston & Sampson's environmental, permitting, and design team, specific tasks included the following:

- Reviewed, updated, and summarized the status of MCP response actions for each Disposal Site through which the Project alignment passes.
- Reviewed, updated, and summarized existing soil and groundwater data.
- Coordinated with landscape architects to assess if design features are appropriately located based on existing soil and groundwater data.
- Coordinated with permitting and design team to evaluate the appropriate stormwater management strategy.
  - Summarized environmental impacts in a letter to MassDEP staff and met with MassDEP and City staff to discuss stormwater management strategy and environmental impacts.
- Calculated estimated surplus soil volumes based on the 75% design documents.
  - Organized estimated surplus soil volumes by parcel and soil disposal category (based on current dataset).
  - Calculated estimated soil management (transportation and disposal) costs based on 75% design documents.
- Reviewed and updated MCP strategy and soil management costs based on updated dataset and 75% design documents.

### **Updated MCP Strategy and Cost Estimates**

#### 13 Wallis Street

The MCP strategy for this parcel depends on if the whole property is purchased or if an easement is acquired; however, prior to the start of construction at the Site, the detected release of arsenic, chromium, lead, and PAHs will require reporting to the MassDEP, and construction will require



management under a Release Abatement Measure (RAM). During construction of the Project, soils excavated will be required to be disposed of at an In-State Landfill facility or an out-of-state facility. Based on the 75% design documents, a total of 932 cubic yards (1,492 tons) of surplus soil will require off-site disposal.

An updated cost estimate for MCP-related items and soil transportation and disposal for the 13 Wallis Street property is summarized in the following table:

<b>MCP Compliance</b>	
RAM Plan, including updated Health and Safety Plan (HASP)	\$10,000
RAM Status Report (2)	\$10,000
Method 3 Risk Characterization	\$7,000
RAM Completion Report	\$10,000
PSS (only for project alignment)	\$25,000
Soil Management & Bills of Lading (2)	\$6,000
<b>Surplus Soil Management</b>	
Transportation and off-site disposal of approximately 1,492 tons of soil	\$103,000
<b>Total \$171,000</b>	

#### 24 Caller Street

Prior to the start of construction at the Site, a RAM Plan will need to be submitted under RTN 3-18180. During construction of the Project, soils will likely be excavated and will be required to be disposed of at an out-of-state facility. Based on the 75% design documents, a total of 1,464 cubic yards (2,342 tons) of surplus soil will require off-site disposal as part of construction of the Project. Additional soil remediation, separate from what is required for Project construction, is required to reduce concentrations of lead, PCBs, and petroleum impacts to soil in order to achieve regulatory closure. Those costs were presented in the July 2020 Draft Analysis of Brownfields Cleanup Alternatives (ABCA), and are provide here as a range in a separate line item.

An updated cost estimate for MCP-related items and soil transportation and disposal for the 24 Caller Street property is summarized in the following table. Please note the "Additional Soil Remediation" costs will need to be updated upon completion of additional assessment activities scheduled for Summer 2021.

<b>MCP Compliance</b>	
RAM Plan, including updated Health and Safety Plan (HASP)	\$10,000
RAM Status Report (2)	\$10,000
Method 3 Risk Characterization	\$7,000
RAM Completion Report	\$10,000
PSS/AUL (included in Additional Soil Remediation)	\$25,000
Soil Management & Bills of Lading (2)	\$6,000
<b>Surplus Soil Management</b>	
Transportation and off-site disposal of approximately 1,154 tons of soil	\$282,000

<b>Additional Soil Remediation (includes hard and soft costs)</b>	
Limited Excavation to Extensive Excavation (ABCA Alt#2 – Alt#3)	\$360,000- \$2,550,000
<b>Total</b>	<b>\$710,000- \$2,900,000</b>

### 21 Caller Street

Prior to the start of construction at the Site, a RAM Plan will need to be submitted under RTN 3-0577. During construction of the Project, soils will likely be excavated and will be required to be disposed of at an In-State Landfill facility. Based on the 75% design documents, a total of 721 cubic yards (1,154 tons) of surplus soil will require off-site disposal.

An updated cost estimate for MCP-related items and soil transportation and disposal for the 21 Caller Street property is summarized in the following table:

<b>MCP Compliance</b>	
RAM Plan, including updated Health and Safety Plan (HASP)	\$10,000
RAM Status Report (2)	\$10,000
Method 3 Risk Characterization	\$7,000
RAM Completion Report	\$10,000
PSS or LSP Opinion Regarding Future Use (only for Project Area)	\$25,000
Soil Management & Bills of Lading (1)	\$3,000
<b>Surplus Soil Management</b>	
Transportation and off-site disposal of approximately 1,154 tons of soil	\$70,000
<b>Total</b>	<b>\$135,000</b>

### 18 Howley Street

Prior to the start of construction at the Site, a RAM Plan will need to be submitted under RTN 3-0577. During construction of the Project, excavated soil will be required to be disposed of at an out-of-state landfill facility. Based on the 75% design documents, a total of 208 cubic yards (332 tons) of surplus soil will require off-site disposal.

An updated cost estimate for MCP-related items and soil transportation and disposal for the 18 Howley Street property is summarized in the following table:

<b>MCP Compliance</b>	
RAM Plan, including updated Health and Safety Plan (HASP)	\$10,000
RAM Status Report (2)	\$10,000
Method 3 Risk Characterization	\$7,000
RAM Completion Report	\$10,000
PSS or LSP Opinion Regarding Future Use (only for Project Area)	\$25,000
Soil Management & Bills of Lading (1)	\$3,000
<b>Surplus Soil Management</b>	
Transportation and off-site disposal of approximately 332 tons of soil	\$40,000
<b>Total</b>	<b>\$105,000</b>



166R Main Street

Prior to the start of construction at the Site, a RAM Plan will need to be submitted under RTN 3-1444. During construction of the Project, excavated soil will be required to be disposed of at an In-State Landfill facility or out-of-state landfill facility. Based on the 75% design documents, a total of 934 cubic yards (1,494 tons) of surplus soil will require off-site disposal.

An updated cost estimate for MCP-related items and soil transportation and disposal for the 166R Main Street property is summarized in the following table:

<b>MCP Compliance</b>	
RAM Plan, including updated Health and Safety Plan (HASP)	\$10,000
RAM Status Report (2)	\$10,000
Method 3 Risk Characterization	\$7,000
RAM Completion Report	\$10,000
PSS or LSP Opinion Regarding Future Use (only for Project Area)	\$25,000
Soil Management & Bills of Lading (2)	\$6,000
<b>Surplus Soil Management</b>	
Transportation and off-site disposal of approximately 1,494 tons of soil	\$134,500
<b>Total</b>	<b>\$202,500</b>

20 Howley Street

Prior to the start of construction at the Site, a RAM Plan will need to be submitted under RTN 3-17492. During construction of the Project, soils will likely be excavated and will be required to be disposed of at an In-State Landfill facility. Based on the 75% design documents, a total of 119 cubic yards (190 tons) of surplus soil will require off-site disposal.

An updated cost estimate for MCP-related items and soil transportation and disposal for the 20 Howley Street property is summarized in the following table:

<b>MCP Compliance</b>	
RAM Plan, including updated Health and Safety Plan (HASP)	\$10,000
RAM Status Report (2)	\$10,000
Method 3 Risk Characterization	\$7,000
RAM Completion Report	\$10,000
PSS or LSP Opinion Regarding Future Use (only for Project Area)	\$25,000
Soil Management & Bills of Lading (1)	\$3,000
<b>Surplus Soil Management</b>	
Transportation and off-site disposal of approximately 190 tons of soil	\$11,500
<b>Total</b>	<b>\$76,500</b>

Summary of Total MCP and Soil Management Costs for the Project

An updated cost estimate for MCP-related items and soil transportation and disposal for the entire Project is summarized in the following table:

<b>MCP Compliance and Soil Management by Property</b>	
13 Wallis Street	\$171,000
24 Caller Street	\$685,000- \$2,875,000
21 Caller Street	\$135,000
18 Howley Street	\$105,000
166R Main Street	\$202,500
20 Howley Street	\$76,500
<b>Total Project Cost</b>	<b>\$1,374,000- \$3,564,000</b>



**APPENDIX H**

Hazardous Building Materials Investigation – 166R Main St – December 2020

December 21, 2020

Mr. Brendan Callahan  
Assistant Director of Planning  
City of Peabody  
24 Lowell Street  
Peabody, MA 01960-3111

**RE: Report of Hazardous Building Materials Investigation  
166R Main Street  
Peabody, MA 01960**

Dear Mr. Callahan:

Weston & Sampson, Inc. (Weston & Sampson) is pleased to present this report of our Hazardous Building Materials Investigation (HBMI) services conducted for building foundations located at 166R Main Street (Site) in Peabody, Massachusetts. Our services were completed in accordance with our March 2020 agreement. In response to the proposed redevelopment of the Site as part of a planned scenic riverwalk, Weston & Sampson performed an investigation to identify asbestos-containing materials, lead paint/coatings and polychlorinated biphenyls (PCBs). The HBMI assessed several foundations and slabs that are the remnants of a light industrial complex in an area that will be utilized as part of the future riverwalk.

A total of five test pits were dug adjacent to each individual foundation to assess for damp proofing potentially applied to foundation walls. And five ~3" concrete cores were drilled through each individual slab to examine the underside for a vapor barrier.

**SURVEY RESULTS**

**Asbestos Survey**

The asbestos survey was performed by Massachusetts-licensed asbestos inspector Mr. Craig Miner (license No.: AI000014) on September 4, 2020. A total of seven samples of suspect asbestos-containing materials were collected. We performed the bulk sampling in the subject area according to methods outlined in the U.S. Environmental Protection Agency (EPA) guidance document titled, "Guidance for Controlling Asbestos-Containing Materials in Buildings" (Document No. 560/5-85/024). Samples were analyzed by EMSL Analytical, Inc. in Woburn, Massachusetts. The results of the sampling are summarized below.

*Samples collected September 4, 2020*

Sample ID	Description	Location	Analytical Result (% Asbestos)
AC5	Coating/Residue on underside of concrete slab	See Sample Location Plan	None detected
AP3	Coating/Residue on concrete foundation	See Sample Location Plan	None detected
AP2	Coating/Residue on concrete foundation	See Sample Location Plan	None detected
AP4	Coating/Residue on concrete foundation	See Sample Location Plan	None detected
AP5	Coating/Residue on concrete foundation	See Sample Location Plan	None detected
AP1	Coating/Residue on concrete foundation	See Sample Location Plan	None detected

Sample ID	Description	Location	Analytical Result (% Asbestos)
AC2	Coating/Residue on underside of concrete slab	See Sample Location Plan	None detected

The EPA and Massachusetts Department of Environmental Protection (MassDEP), consider materials identified to contain greater than or equal to 1% asbestos to be asbestos-containing materials (ACMs). As shown in the tables above, none of the building materials sampled by Weston & Sampson contained asbestos exceeding 1%. According to MassDEP regulations, ACMs must be removed by a licensed contractor prior to any activity that would disturb the material. All suspect asbestos-containing materials were noted to be in generally good condition at the time of the survey.

#### *Asbestos Limitations*

Our survey did not include an evaluation of soils or underground materials (other than damp proofing and vapor barriers) that may be present at the Site. Limited exploratory demolition was performed to access potentially hidden materials applied to foundation walls and slabs. In addition to the above listed materials, other suspect ACMs may be present at the Site or within other building areas that may not have been accessible by Weston & Sampson during our survey. Weston & Sampson recommends that if any suspect materials are uncovered during demolition or renovation activities that were not identified during the survey, that the materials be sampled and analyzed for asbestos content prior to disturbance. This document is not intended to be nor will it suffice to serve as a bid document or specification.

**Per Massachusetts Department of Environmental Protection (MassDEP) regulations, the owner/operator must maintain a copy of this written asbestos survey report at the subject facility for at least two years. If the facility is unstaffed or if it is demolished, the owner/operator must maintain a copy at their regular place of business.**

#### Lead Paint Screening

As part of the HBMI, Weston & Sampson performed an evaluation for suspect lead paint coatings. No paints or coatings were observed in the subject area.

#### Polychlorinated Biphenyls (PCB) Survey

As part of the HBMI, Weston & Sampson performed an evaluation for suspect PCB-impacted building materials, including caulks, sealants, and paints. No suspect PCB-impacted materials were observed in the subject area.

#### Preliminary Cost Estimates

Weston & Sampson has developed preliminary demolition cost estimates using current bid pricing for the removal of uncoated, unstained concrete/masonry based on field observations and limited available information. We estimate the cost to perform complete demolition and removal of approximately 1,100 tons of concrete at the Site to range from \$70,000 to \$95,000. We estimate the cost to perform select demolition and removal of approximately 450 tons of concrete necessary to install the riverwalk at the Site to range from \$35,000 to \$45,000. Market conditions will affect demolition costs. Additionally, demolition costs may be affected if multiple phases of demolition are conducted compared to a single project.



We appreciate the opportunity to assist you with this project. If you have any questions or require any additional information, please do not hesitate to contact us at (978) 532-1900.

Very truly yours,

WESTON & SAMPSON ENGINEERS, INC.



Paul V. Uzgiris, PE  
Team Leader



Craig Miner, LEED AP  
Senior Project Manager

**Attachments:**

- Laboratory analytical results
- Sample location plan



# EMSL Analytical, Inc.

5 Constitution Way, Unit A Woburn, MA 01801

Tel/Fax: (781) 933-8411 / (781) 933-8412

<http://www.EMSL.com> / [bostonlab@emsl.com](mailto:bostonlab@emsl.com)

EMSL Order: 132006366

Customer ID: WESA62

Customer PO:

Project ID:

**Attention:** Craig Miner  
Weston & Sampson Engineers, Inc.  
55 Walkers Brook Drive  
Suite 100v  
Reading, MA 01867

**Phone:** (978) 532-1900

**Fax:** (978) 977-0100

**Received Date:** 09/08/2020 5:30 PM

**Analysis Date:** 09/15/2020

**Collected Date:** 09/04/2020

**Project:** Peabody MVP

## Test Report: Asbestos Analysis of Bulk Materials via EPA 600/R-93/116 Method using Polarized Light Microscopy

Sample	Description	Appearance	Non-Asbestos		Asbestos
			% Fibrous	% Non-Fibrous	% Type
AC5 <small>132006366-0001</small>	AC5 - Coating/Residue on Concrete	Black Non-Fibrous Homogeneous		100% Non-fibrous (Other)	None Detected
AP3 <small>132006366-0002</small>	AP3 - Coating/Residue on Concrete	Brown Non-Fibrous Homogeneous		100% Non-fibrous (Other)	None Detected
AP2 <small>132006366-0003</small>	AP2 - Coating/Residue on Concrete	Brown Non-Fibrous Homogeneous		100% Non-fibrous (Other)	None Detected
AP4 <small>132006366-0004</small>	AP4 - Coating/Residue on Concrete	Brown Non-Fibrous Homogeneous		100% Non-fibrous (Other)	None Detected
AP5 <small>132006366-0005</small>	AP5 - Coating/Residue on Concrete	Brown/Black Non-Fibrous Homogeneous		100% Non-fibrous (Other)	None Detected
AP1 <small>132006366-0006</small>	AP1 - Coating/Residue on Concrete	Brown Non-Fibrous Homogeneous		100% Non-fibrous (Other)	None Detected
AC2 <small>132006366-0007</small>	AC2 - Coating/Residue on Concrete	Brown Non-Fibrous Homogeneous		100% Non-fibrous (Other)	None Detected

Analyst(s)

Kevin Pine (7)

Steve Grise, Laboratory Manager  
or Other Approved Signatory

EMSL maintains liability limited to cost of analysis. Interpretation and use of test results are the responsibility of the client. This report relates only to the samples reported above, and may not be reproduced, except in full, without written approval by EMSL. EMSL bears no responsibility for sample collection activities or analytical method limitations. The report reflects the samples as received. Results are generated from the field sampling data (sampling volumes and areas, locations, etc.) provided by the client on the Chain of Custody. Samples are within quality control criteria and met method specifications unless otherwise noted. The above analyses were performed in general compliance with Appendix E to Subpart E of 40 CFR (previously EPA 600/M4-82-020 "Interim Method") but augmented with procedures outlined in the 1993 ("final") version of the method. This report must not be used by the client to claim product certification, approval, or endorsement by NVLAP, NIST or any agency of the federal government. Non-friable organically bound materials present a problem matrix and therefore EMSL recommends gravimetric reduction prior to analysis. Unless requested by the client, building materials manufactured with multiple layers (i.e. linoleum, wallboard, etc.) are reported as a single sample. Estimation of uncertainty is available on request.

Samples analyzed by EMSL Analytical, Inc. Woburn, MA NVLAP Lab Code 101147-0, CT PH-0315, MA AA000188, RI AAL-139, VT AL998919, Maine Bulk Asbestos LB-0039

Initial report from: 09/15/2020 17:32:21



EMSL ANALYTICAL, INC.  
LABORATORY • PRODUCTS • TRAINING

### Asbestos Bulk Building Material Chain of Custody

EMSL Order Number (Lab Use Only):

132006366

EMSL ANALYTICAL, INC.  
200 ROUTE 130 NORTH  
CINNAMINSON, NJ 08077  
PHONE: (800) 220-3675  
FAX: (856) 786-5974

Company: <u>Weston + Sampson</u>		EMSL-Bill to: <input checked="" type="checkbox"/> Same <input type="checkbox"/> Different <small>If Bill to is Different note instructions in Comments**</small>	
Street: <u>55 Walkers Brook Dr.</u>		<i>Third Party Billing requires written authorization from third party</i>	
City: <u>Reading</u>	State/Province: <u>MA</u>	Zip/Postal Code:	Country:
Report To (Name): <u>Craig Miner</u>		Telephone #:	
Email Address: <u>miner@wscinc.com</u>		Fax #:	Purchase Order:
Project Name/Number: <u>Perbody MVP</u>		Please Provide Results: <input type="checkbox"/> Fax <input type="checkbox"/> Email	
U.S. State Samples Taken: <u>MA</u>		CT Samples: <input type="checkbox"/> Commercial/Taxable <input type="checkbox"/> Residential/Tax Exempt	

**Turnaround Time (TAT) Options\* - Please Check**

3 Hour  
  6 Hour  
  24 Hour  
  48 Hour  
  72 Hour  
  96 Hour  
  1 Week  
  2 Week

\*For TEM Air 3 hr through 6 hr, please call ahead to schedule. \*There is a premium charge for 3 Hour TEM AHERA or EPA Level II TAT. You will be asked to sign an authorization form for this service. Analysis completed in accordance with EMSL's Terms and Conditions located in the Analytical Price Guide.

PLM - Bulk (reporting limit)	TEM - Bulk
<input checked="" type="checkbox"/> PLM EPA 600/R-93/116 (<1%) <input type="checkbox"/> PLM EPA NOB (<1%) Point Count <input type="checkbox"/> 400 (<0.25%) <input type="checkbox"/> 1000 (<0.1%) Point Count w/Gravimetric <input type="checkbox"/> 400 (<0.25%) <input type="checkbox"/> 1000 (<0.1%) <input type="checkbox"/> NIOSH 9002 (<1%) <input type="checkbox"/> NY ELAP Method 198.1 (friable in NY) <input type="checkbox"/> NY ELAP Method 198.6 NOB (non-friable-NY) <input type="checkbox"/> OSHA ID-191 Modified <input type="checkbox"/> Standard Addition Method	<input type="checkbox"/> TEM EPA NOB - EPA 600/R-93/116 Section 2.5.5.1 <input type="checkbox"/> NY ELAP Method 198.4 (TEM) <input type="checkbox"/> Chatfield Protocol (semi-quantitative) <input type="checkbox"/> TEM % by Mass - EPA 600/R-93/116 Section 2.5.5.2 <input type="checkbox"/> TEM Qualitative via Filtration Prep Technique <input type="checkbox"/> TEM Qualitative via Drop Mount Prep Technique
<b>Other</b>	
<input type="checkbox"/>	

Check For Positive Stop - Clearly Identify Homogenous Group      Date Sampled: 9-04-20

Samplers Name: Craig Miner      Samplers Signature:

Sample #	HA #	Sample Location	Material Description
<u>AC5</u>		<u>AC5</u>	(containing) residue on concrete 
<u>AP3</u>		<u>AP3</u>	
<u>AP2</u>		<u>AP2</u>	
<u>AP4</u>		<u>AP4</u>	
<u>AP5</u>		<u>AP5</u>	
<u>AP1</u>		<u>AP1</u>	
<u>AC2</u>		<u>AC2</u>	

Client Sample # (s): <u>AC5</u> - <u>AC2</u>	Total # of Samples: <u>7</u>
Relinquished (Client):	Date: <u>9-8-20</u> Time: <u>1045</u>
Received (Lab):	Date:      Time:
Comments/Special Instructions:	

REC'D  
EMSL-BOSTON     
 SEP 08 2020



166R Main Street  
Peabody, MA  
Approximate location  
of cores, test pits and  
samples

Proctor Brook

AC5

AP5

AC4

AC3

AP4

AP3

AC2

AC1

AP2

AP1

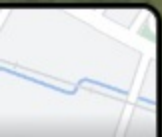

## APPENDIX I

### Community Engagement Materials & Feedback



# NORTH RIVER RESILIENCY, CANAL WALL, AND RIVERWALK PROJECT

## VIRTUAL PRESENTATION AND DISCUSSION

---

Tuesday, **January 12th**, 2021  
6:30 – 7:30 PM



Learn about the North River Resiliency, Canal Wall, and Riverwalk Project by attending a public meeting on January 12, 2021!

**The meeting will be held virtually, beginning at 6:30 p.m** and the presentation will be followed by a Question & Answer session. **Read more about the event at [tinyurl.com/RiverwalkWebinar1](https://tinyurl.com/RiverwalkWebinar1).**

**Please RSVP by noon on January 11th.** A virtual meeting link will be shared via email on the evening of January 11th, along with instructions for joining the call.

For more information, please contact Brendan Callahan, Assistant Director of Planning for the City of Peabody at: [brendan.callahan@peabody-ma.gov](mailto:brendan.callahan@peabody-ma.gov) or 978-538-5780.

---



# PEABODY RIVERWALK

Mayor Edward A. Bettencourt, Jr.

**PUBLIC MEETING  
JANUARY 12, 2021**

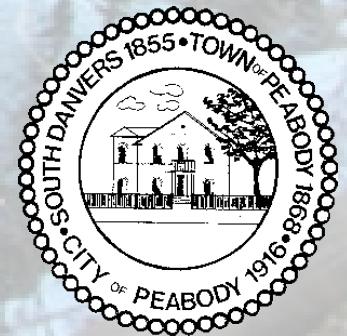

# MEETING GUIDELINES

- Please stay muted during presentation
- Questions and Comments
  - You are encouraged to leave questions in Slido, however, leaving them in the Teams video chat works too
  - We will pause periodically to address questions

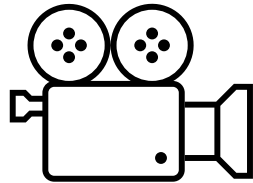

we're recording!

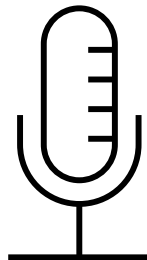

mute



raise your hand

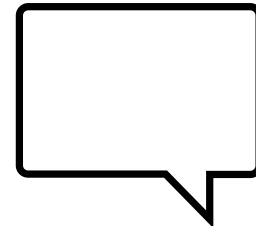

chat

*we're using Slido!*

# SLIDO

Open a web browser

Type in slido.com

Enter code: **riverwalk**

Joining as a participant?

# Enter code here

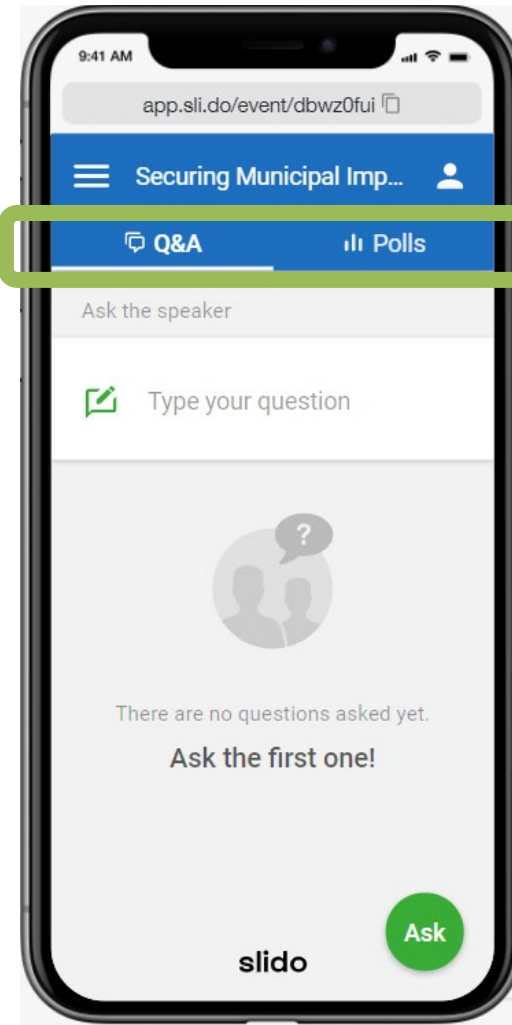

You can move between the Q&A tab and the polls tab!



slido

Where do you live in Peabody?

 Start presenting to display the poll results on this slide.

slido

What are you most excited about for the  
riverwalk?

 Start presenting to display the poll results on this slide.

# WHO'S IN THE ZOOM



**Brendan Callahan**  
City of Peabody



**Cass Chroust**  
Weston & Sampson



**Adria Boynton**  
Weston & Sampson



**Sarah DeStefano**  
Weston & Sampson



**George Naslas**  
Weston & Sampson



# AGENDA

- **Project re-cap and funding history**
- **Q & A**
- **Where we are today**
- **24 Caller Street options**
- **Polling Questions / Visioning**
- **Next steps**
- **Q & A**



# WELCOME



# PROJECT RE-CAP

## History and Background

- Former Industrial Corridor
- *Leather Capital of the World*
- Envisioned in early 1990's
- Revitalize the Corridor
- Spur Economic Development
- Flood Mitigation
- Create a Recreational Resource

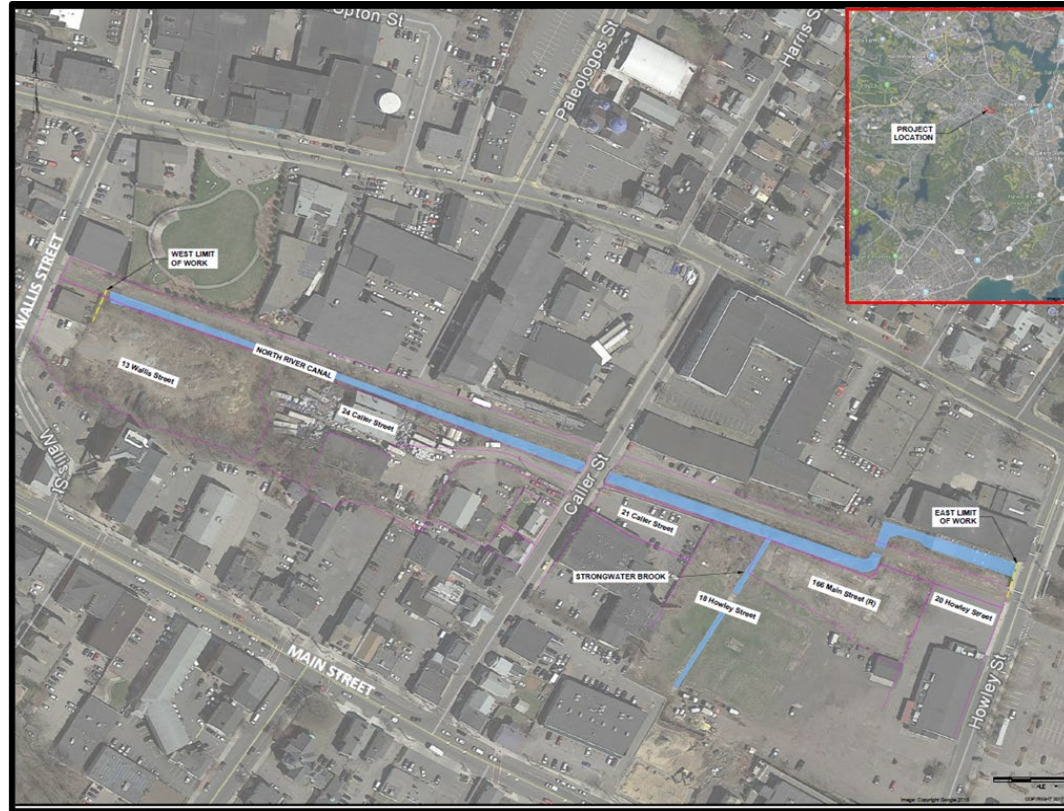



# PROJECT RE-CAP

Approximately 22 parcels (15-16 acres) have potential frontage along the proposed downtown Riverwalk.

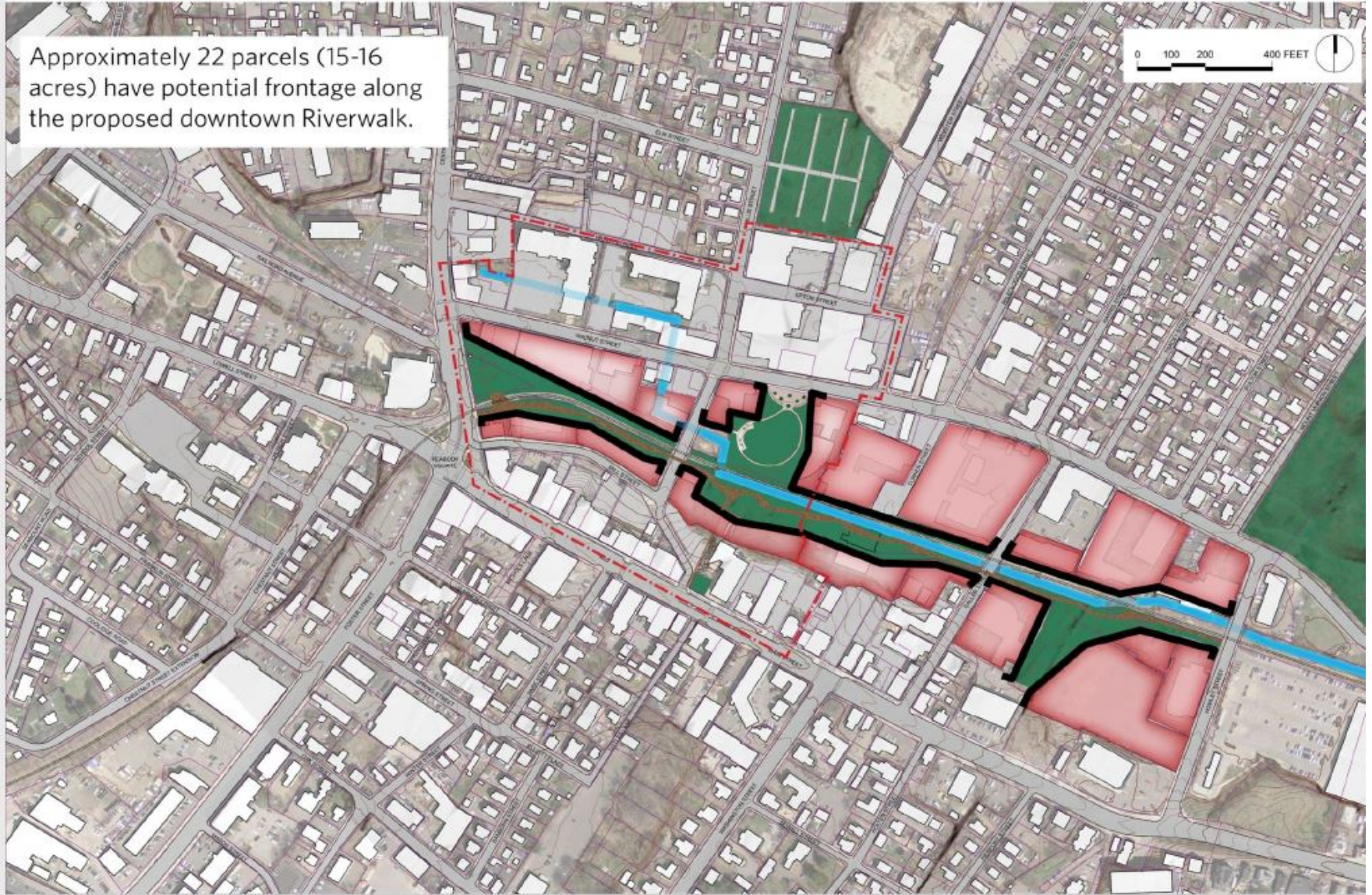



# PROJECT RE-CAP

## Downtown Corridor





# PROJECT RE-CAP

## Resiliency Evaluation



- **Flood Mapping**
  - Current flood conditions
  - Future flood conditions under climate change
- **Potential Opportunities to Store Flood Water**
- **Evaluate Wall Options**



# PROJECT RE-CAP

## Resiliency Evaluation: Flooding Scenarios

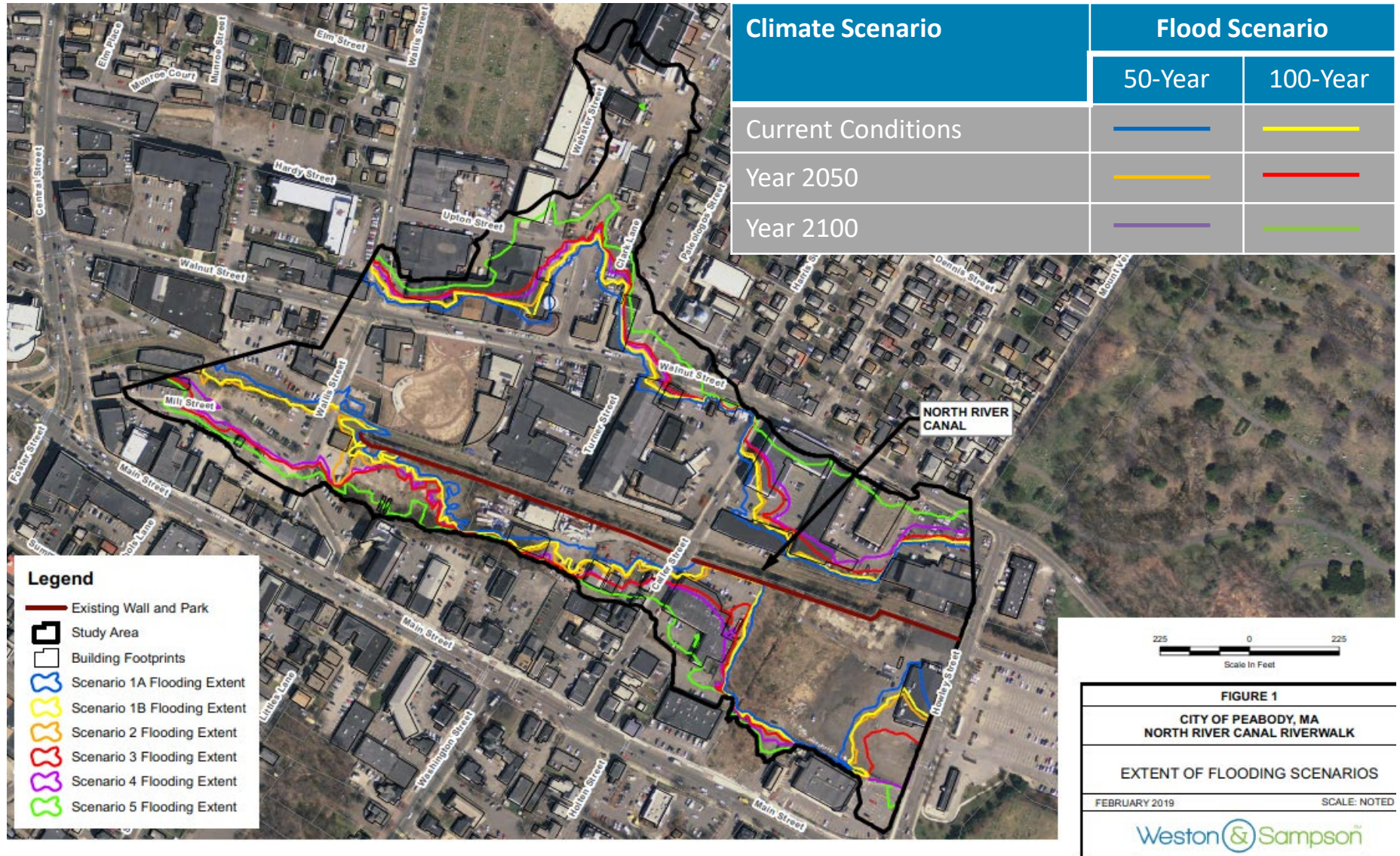



# PROJECT RE-CAP

## Wall Analysis and Repair

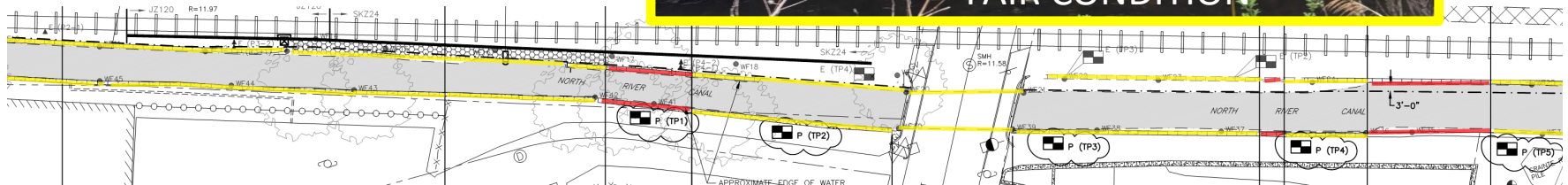

# PROJECT RE-CAP

Previous Public Engagement – Last Meeting: May 30, 2019

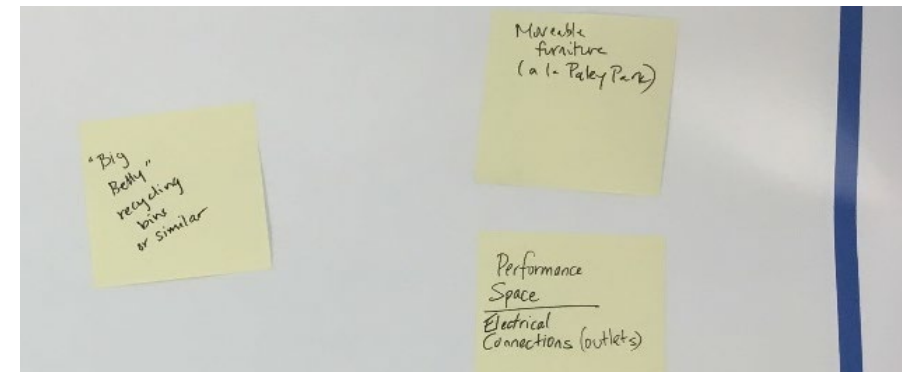
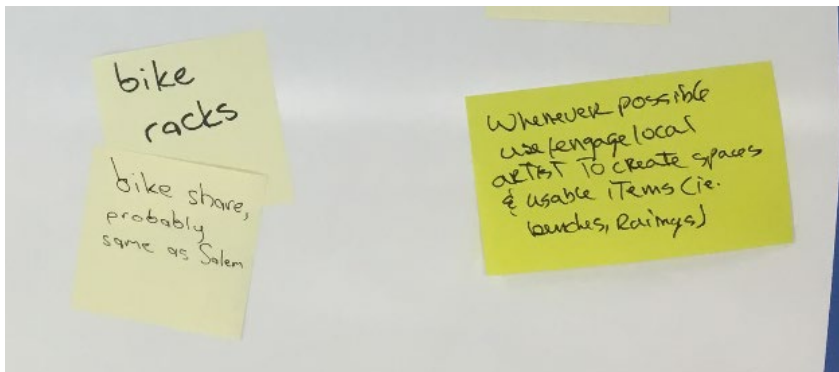
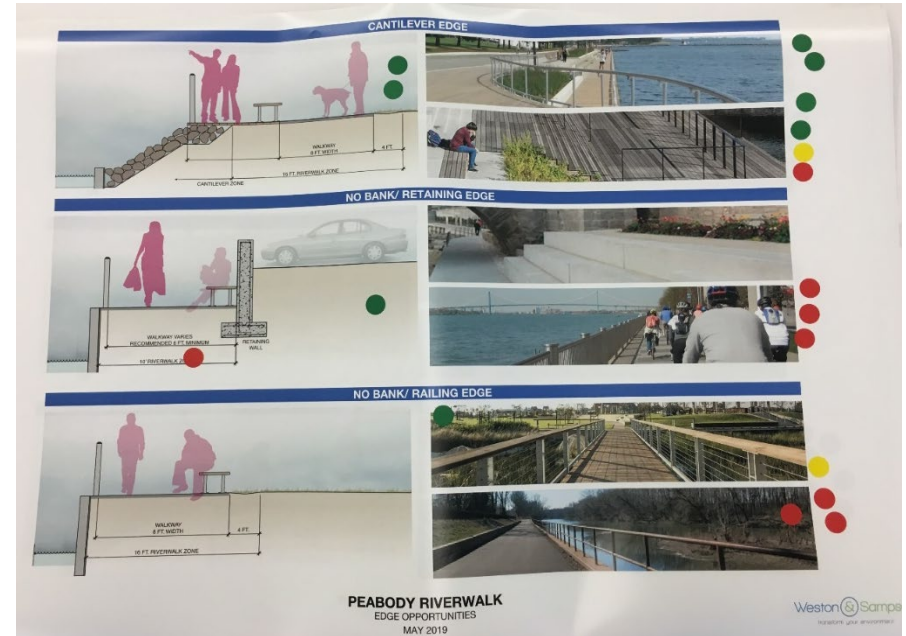





# PROJECT RE-CAP

## Funding

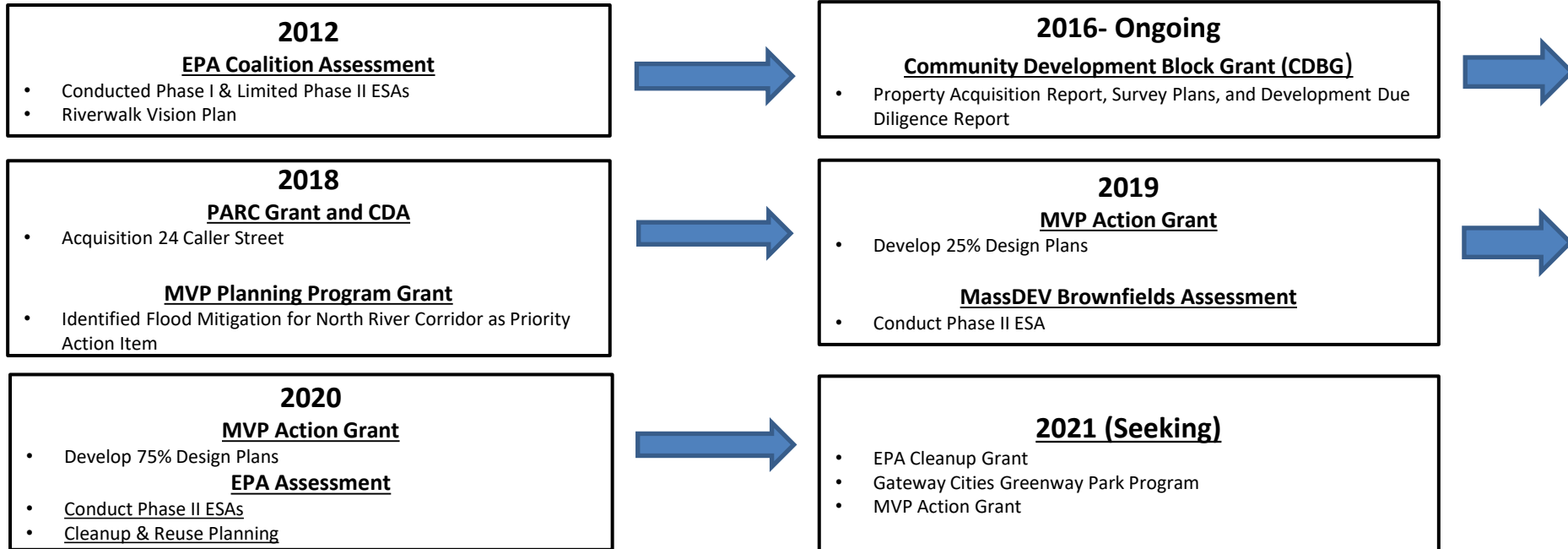

Source	City Amount	State/Federal Amount	Date
CDBG		\$243,400	Nov 2016-Ongoing
PARC/CDA	157,400	\$142,600	July 1, 2018- June 30, 2019
MVP Action Grant (FY19)	\$75,000	\$225,000	July 1, 2018 – June 30, 2019
MD Assessment		\$93,000	June 30, 2020
MVP Action Grant (FY20)	\$121,788	\$365,014	Feb 1, 2020-June 30, 2021
EPA BF Assessment Grant		\$300,000	Oct 1, 2020-Sept 30, 2023
<b>Total</b>	<b>\$441,588</b>	<b>\$1,369,014</b>	<b>\$1,810,602</b>

slido

# Audience Q&A Session

 Start presenting to display the audience questions on this slide.



# WHERE WE ARE TODAY

## Site Plan





# WHERE WE ARE TODAY

## Site Plan

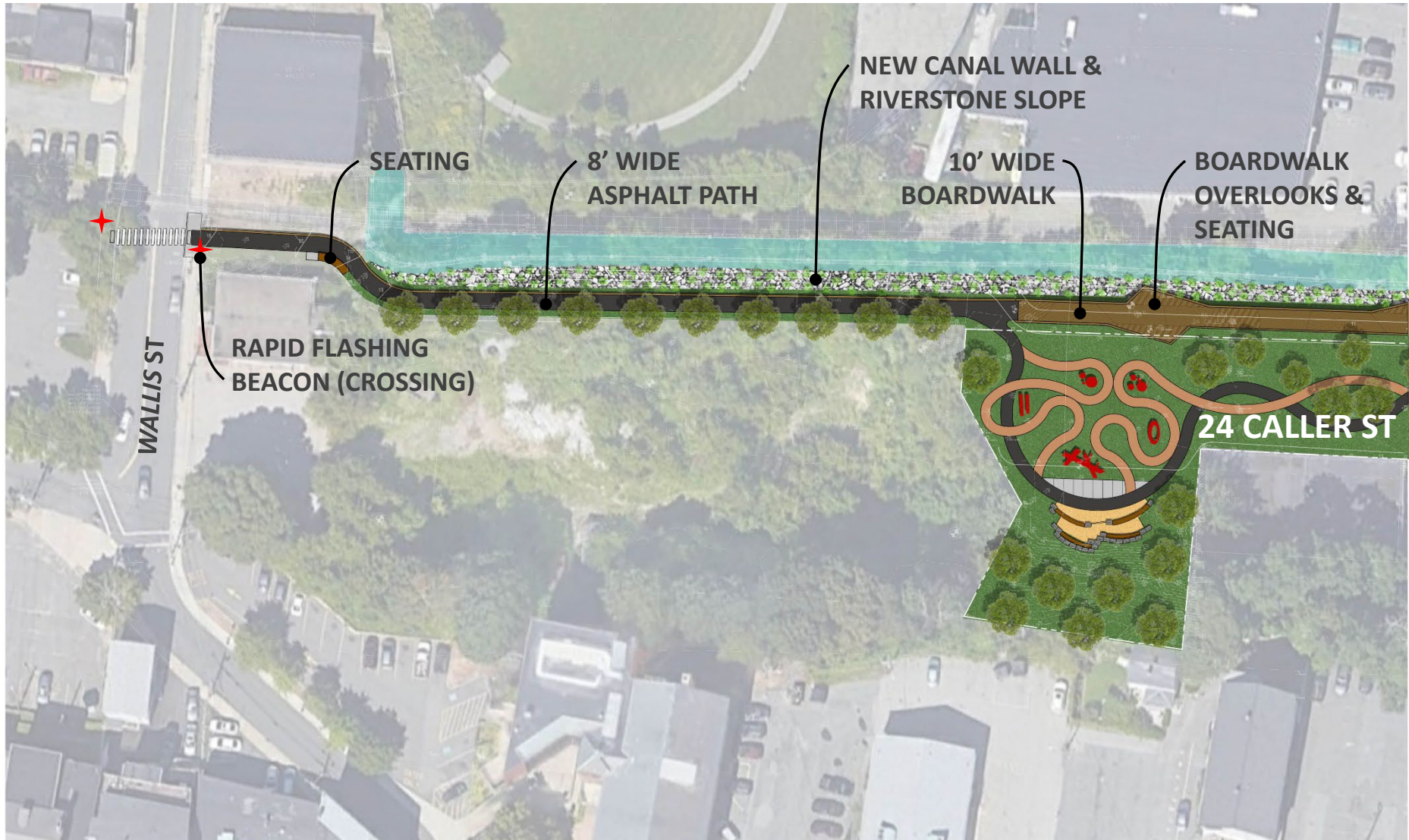



# WHERE WE ARE TODAY

## Site Plan

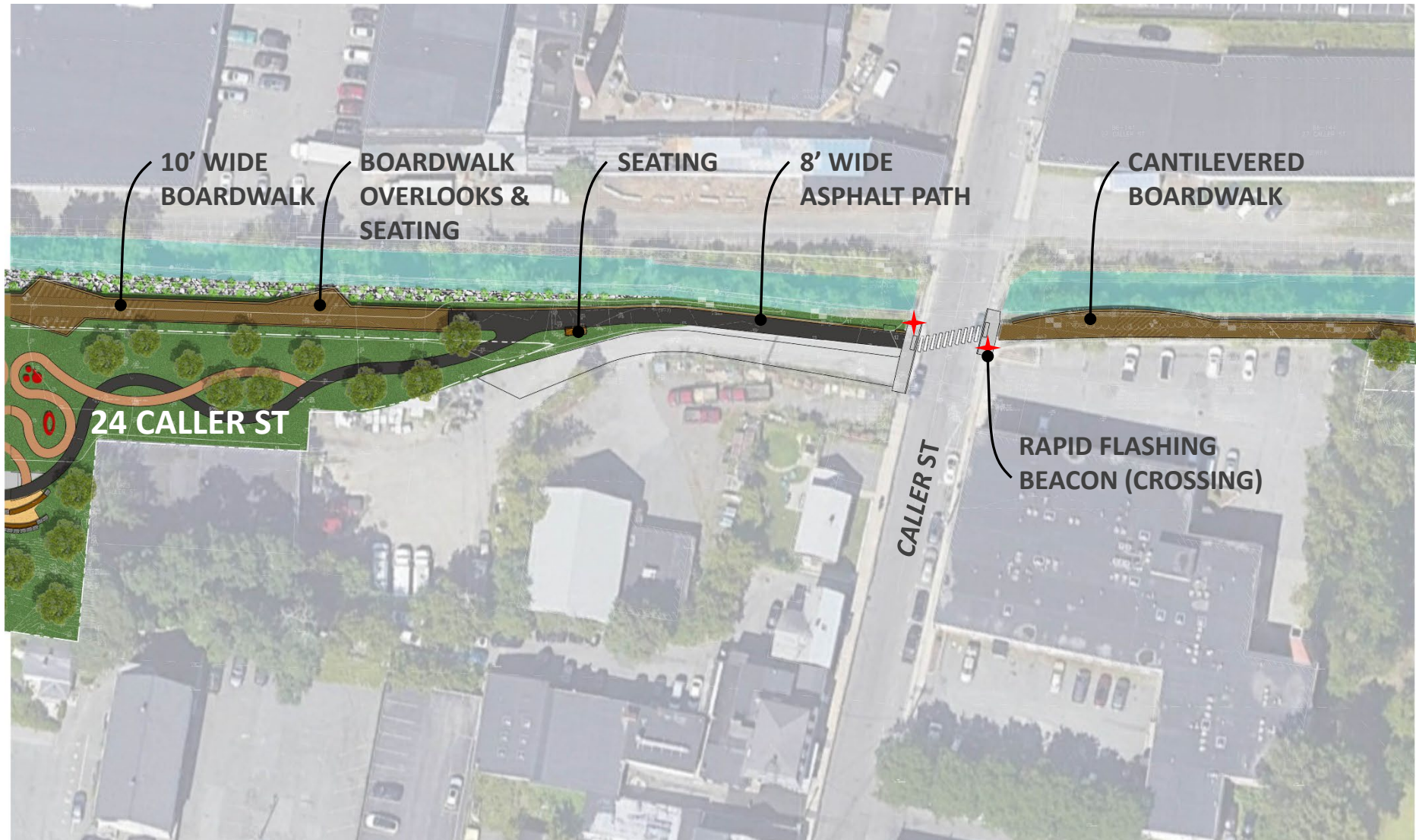



# WHERE WE ARE TODAY

## Site Plan

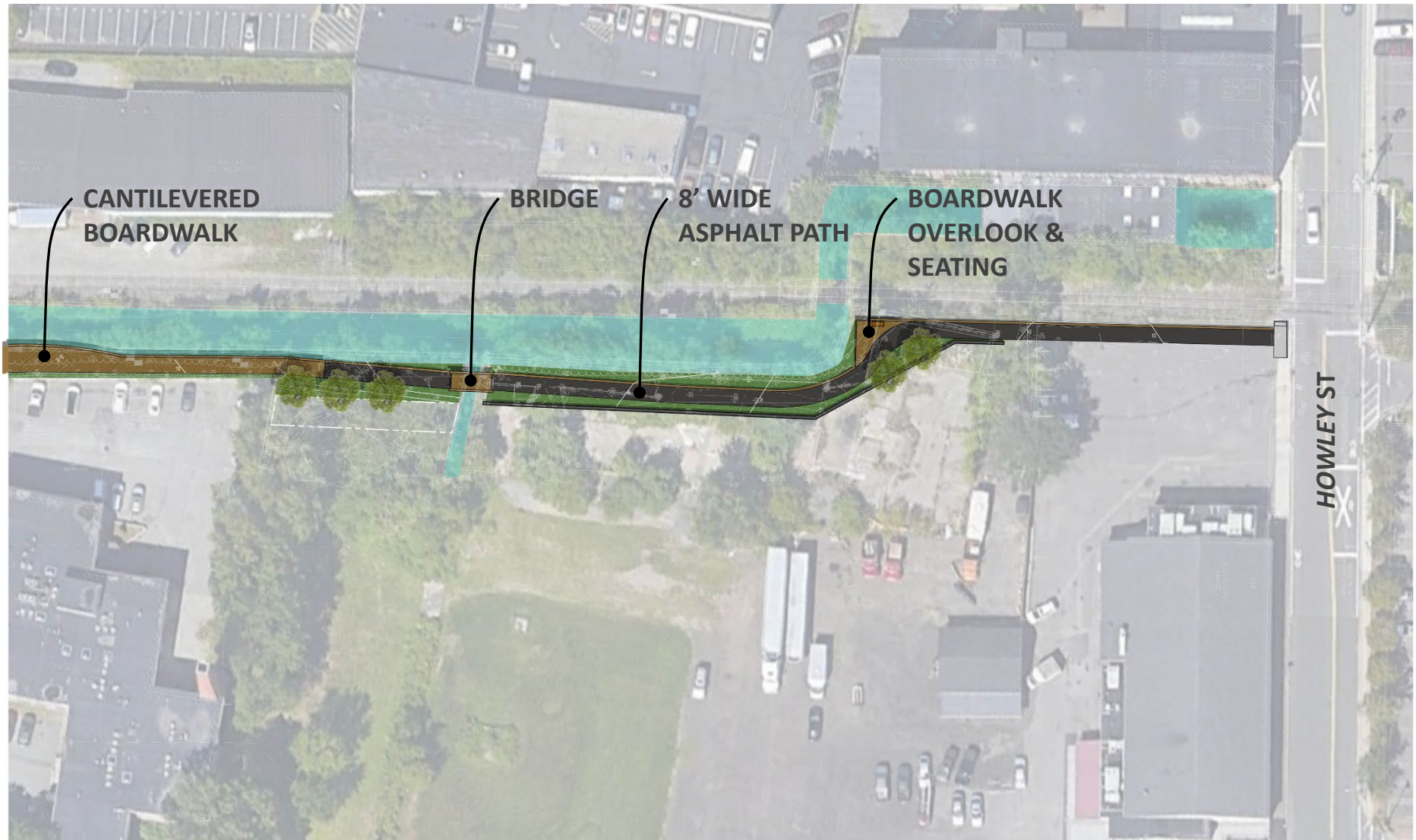



# WHERE WE ARE TODAY

## Riverwalk Elements

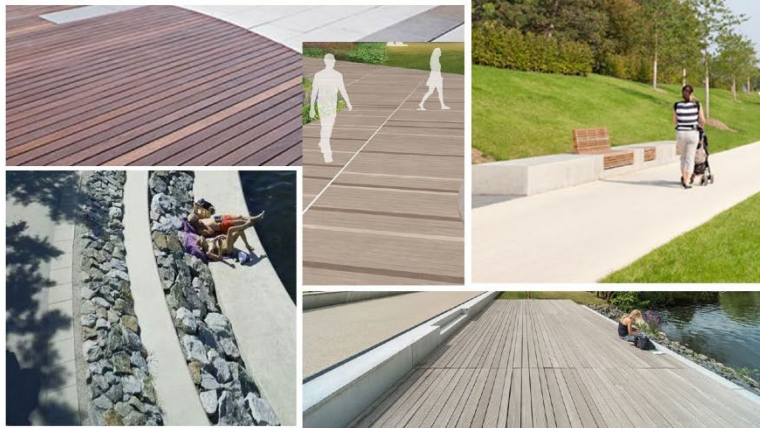

**Walkway Surfacing Materials**

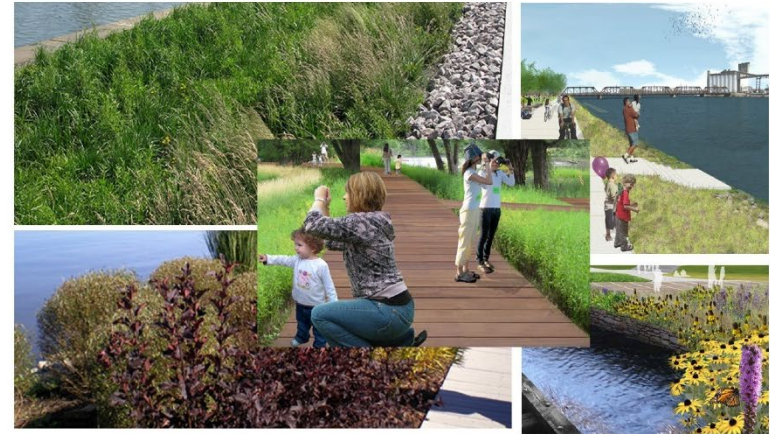

**Native Plant Materials**



**Boardwalk Railing Options**



**New Canal Wall & Riverstone Slope**



# 24 CALLER STREET – OPTION 1

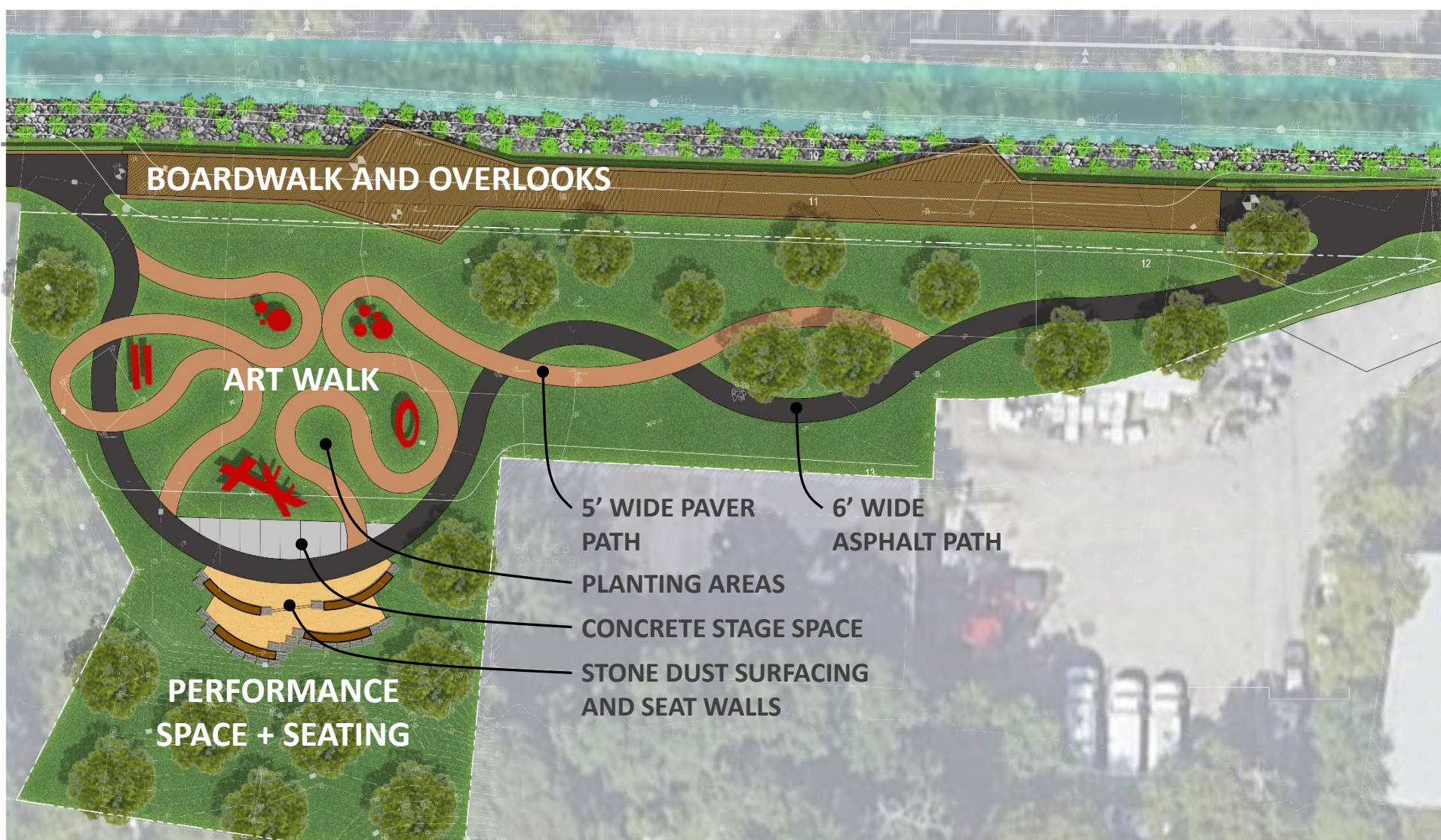



# 24 CALLER STREET – OPTION 1

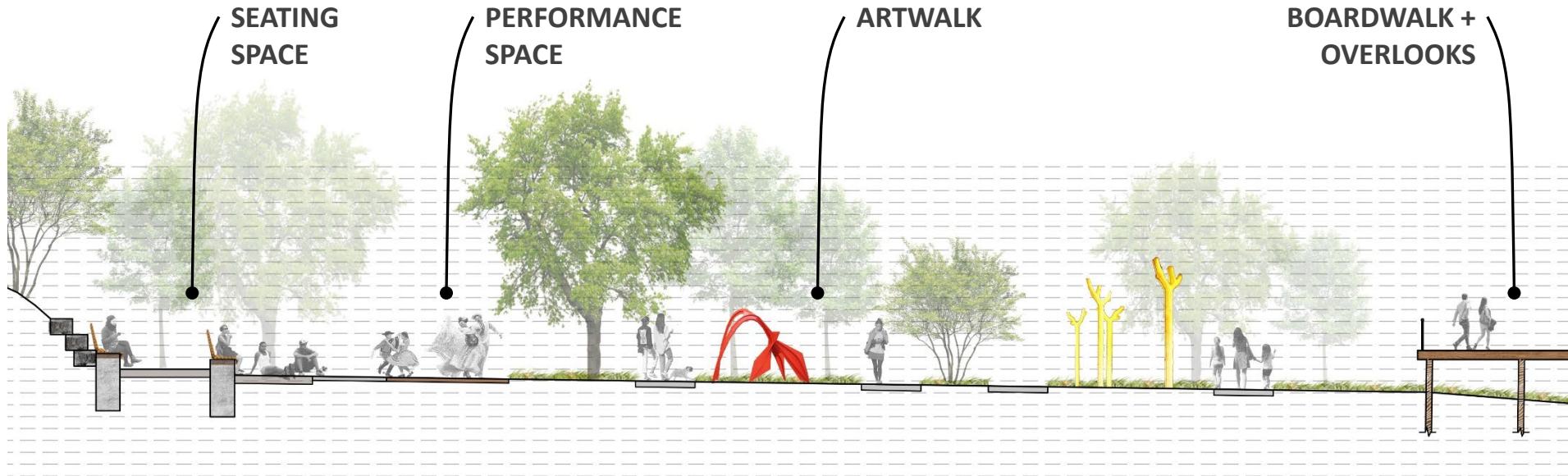

# 24 CALLER STREET – OPTION 1

## Precedent Images





# 24 CALLER STREET – OPTION 2

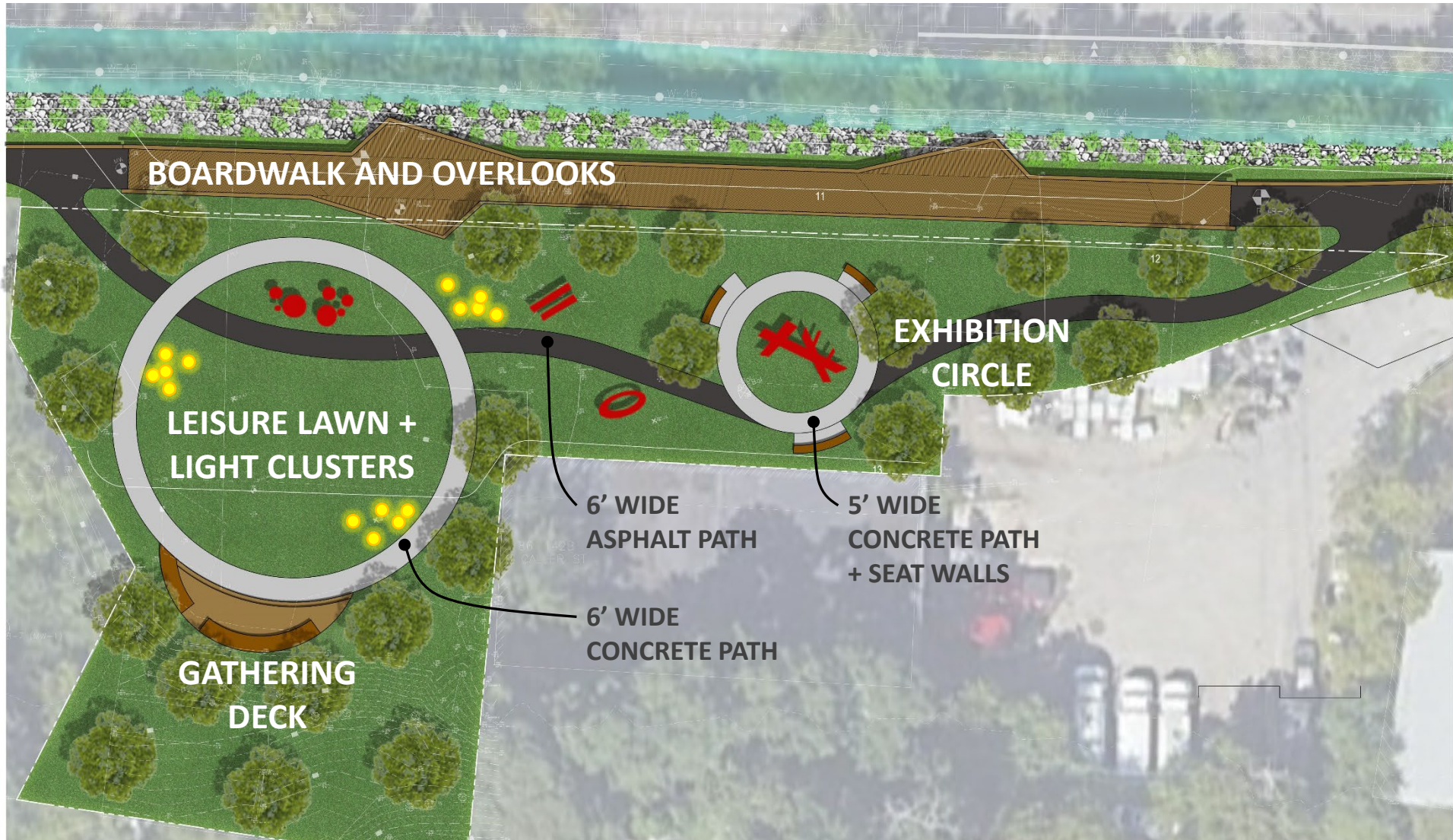



# 24 CALLER STREET – OPTION 1

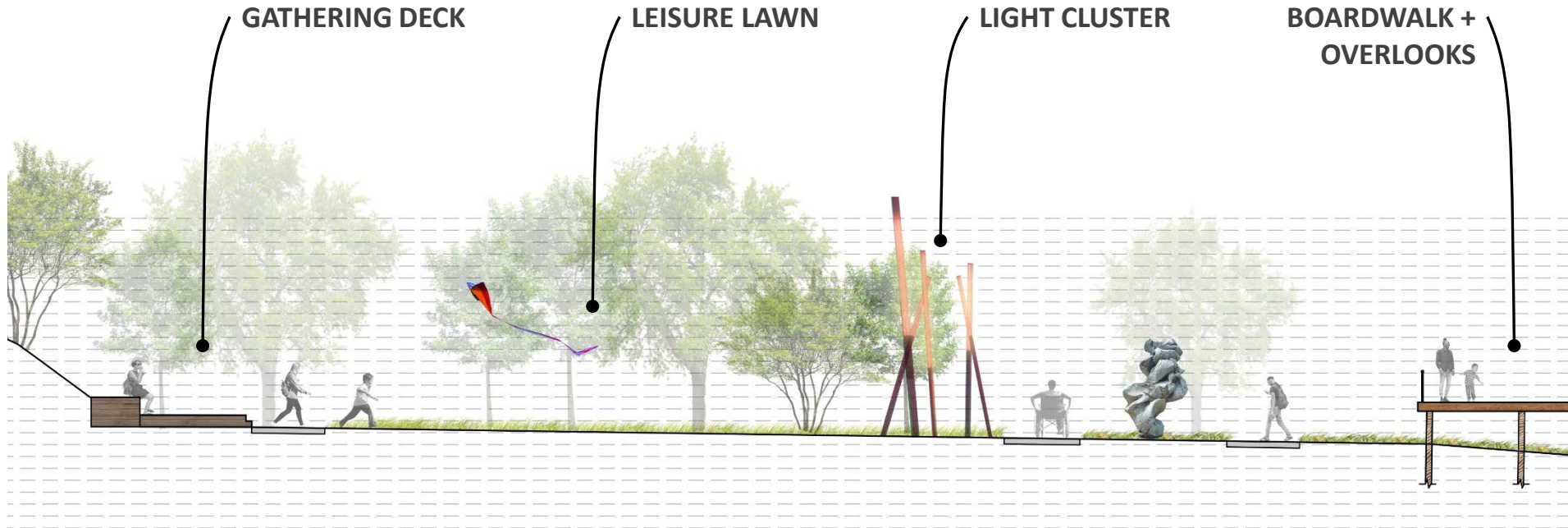

# 24 CALLER STREET – OPTION 2

## Precedent Images





slido

What would be your primary use of the  
Riverwalk?

 Start presenting to display the poll results on this slide.

slido

What activities would you frequently use the Riverwalk for?

 Start presenting to display the poll results on this slide.



slido

How often would you use the Riverwalk?

 Start presenting to display the poll results on this slide.

slido

How well does the proposed Riverwalk  
(excluding 24 Caller Street) meet your travel and  
recreation needs?

 Start presenting to display the poll results on this slide.



slido

What would you like to see more of in the proposed Riverwalk plans?

 Start presenting to display the poll results on this slide.

slido

Do you support incorporating public art along  
the Riverwalk?

 Start presenting to display the poll results on this slide.



slido

Please select which option you like best at 24  
Caller Street.

 Start presenting to display the poll results on this slide.

slido

Is there anything missing from your preferred option that you would like to see included at 24 Caller Street?

 Start presenting to display the poll results on this slide.



slido

Do you prefer the PERFORMANCE SPACE AND SEATING in Option 1 or the GATHERING DECK in Option 2?

 Start presenting to display the poll results on this slide.

slido

Do you prefer the ART WALK in Option 1 or the  
LEISURE LAWN and EXHIBITION CIRCLE in  
Option 2?

 Start presenting to display the poll results on this slide.

slido

Do you like the idea of Light Clusters as shown  
in Option 2?

 Start presenting to display the poll results on this slide.



# NEXT STEPS



- Synthesize Feedback from the Public Engagement and other Stakeholders
- Submit 75% Design Documentation for Permitting and Other Grant-related Submissions
- Apply for Additional Grant Funding
- Complete 75% Construction Documentation in 2021 / 2022

slido

# Audience Q&A Session

 Start presenting to display the audience questions on this slide.

# FOR MORE INFORMATION OR TO PROVIDE ADDITIONAL FEEDBACK:

**Brendan Callahan** - Asst. Director of Planning, City of Peabody  
978-538-5780

[brendan.callahan@peabody-ma.gov](mailto:brendan.callahan@peabody-ma.gov)

**Cass Chroust** - Landscape Architect, Weston & Sampson  
[chroustc@wseinc.com](mailto:chroustc@wseinc.com)

**Sarah DeStefano** – Team Leader, Weston & Sampson  
[destefanos@wseinc.com](mailto:destefanos@wseinc.com)

**George Naslas, LSP** – Vice President, Weston & Sampson  
[naslasg@wseinc.com](mailto:naslasg@wseinc.com)



THANK YOU















## Event summary report North River Resiliency, Canal Wall, and Riverwalk Webinar

 Active users <b>43</b>	
Engagement score	<b>470</b>
Engagement per user	<b>10.9</b>

 Questions <b>64</b>	
Likes / dislikes	<b>71 / 0</b>
Anonymous rate	<b>94%</b>









 Poll votes <b>335</b>	
Polls created	<b>13</b>
Votes per poll	<b>26</b>

### Popular questions

 Anonymous today, 12:10am	0  6 
Will there be continuous light at night along the path?	
 Anonymous today, 12:17am	0  6 
We have 2 beautiful new green spaces (East End, Leather City) both have rarely used performance spaces. How is Caller St different in function than East End?	
 Anonymous today, 12:27am	0  6 
Consider including historical recognition that N. River was once known as Naumkeag River, named for the Native American ppl that once inhabited the area.	
 Anonymous today, 12:18am	0  4 
Litter is a problem at East End Park. Will there be outdoor trash/recycling bins?	
 Anonymous today, 12:10am	0  3 
What connections are planned to downtown (ie main st)? Will it be accessible (for example) in the green space behind the library?	



### Influential users

 Rita Cavicchio	3  4 
 Deanne Healey	1  2 
 Anonymous users	60  65 

# North River Resiliency, Canal Wall, and Riverwalk Webinar

12 - 12 Jan 2021

Poll results



# Table of contents

- Where do you live in Peabody?
- What are you most excited about for the riverwalk?
- How well does the proposed Riverwalk (excluding 24 Caller Street) meet your travel and recreation needs?
- What would you like to see more of in the proposed Riverwalk plans?
- How often would you use the Riverwalk?
- Do you support incorporating public art along the Riverwalk?
- Please select which option you like best at 24 Caller Street.
- Is there anything missing from your preferred option that you would like to see included at 24 Caller Street?
- Do you prefer the PERFORMANCE SPACE AND SEATING in Option 1 or the GATHERING DECK in Option 2?
- Do you prefer the ART WALK in Option 1 or the LEISURE LAWN and EXHIBITION CIRCLE in Option 2?
- What activities would you frequently use the Riverwalk for?

## Table of contents

- Do you like the idea of Light Clusters as shown in Option 2?
- What would be your primary use of the Riverwalk?

# Where do you live in Peabody?

0 2 6

East End



Downtown



West Peabody



South Peabody



Other



I don't live in Peabody





# What are you most excited about for the riverwalk?

0 2 7



# How well does the proposed Riverwalk (excluding 24 Caller Street) meet your travel and recreation needs?

0 2 8

Very well



Pretty well



Not very well



Not at all



I'm not sure



## What would you like to see more of in the proposed Riverwalk plans? (1/2)

0 2 6

Lawn space

Lighting

Vegetation

Instagrammable spots

Bird observation?

- mile markers
- cleanup of surrounding areas
- Historic/interpretive markers
  - Butterfly Waystation
- plantings
  - Small garden
- Instagrammable spots :)
  - Modern art and history
  - Water feature
  - Lighting and Peabody History
  - Interpretative markers and history
  - connection to square
  - Plantings
- Trees. Botanical signs
- Cleanliness and safety
- lawn space, artwork, dog area
- I would like more Trees and possibly a bird observation area.
  - More open space and landscaping
  - lighting, public art, visible security
  - lots of trees
  - Lighting!
  - Swings
  - history, outdoor gym
  - Lawn space, open recreation for different program options



## What would you like to see more of in the proposed Riverwalk plans? (2/2)

- Lighting, blue safety stations
  - Seating and opportunities for community engagement
  - lighting
  - Seating, lighting
  - Leisure, option 2 for 24 caller seems ideal
  - Dog friendly space
  - Connection to existing spaces - businesses on Main Street and green space at East End
  - Trees, flowers, and plants.
  - More lighting and art
  - Public art
  - flowers, public art and lighting
- Lawn space  
Lighting

# How often would you use the Riverwalk?

0 2 6

Several times a week



A couple times a week



On occasion



Never



## Do you support incorporating public art along the Riverwalk?

0 2 3

Yes



No



I'm not sure





**Please select which option you like best at 24  
Caller Street.**

030

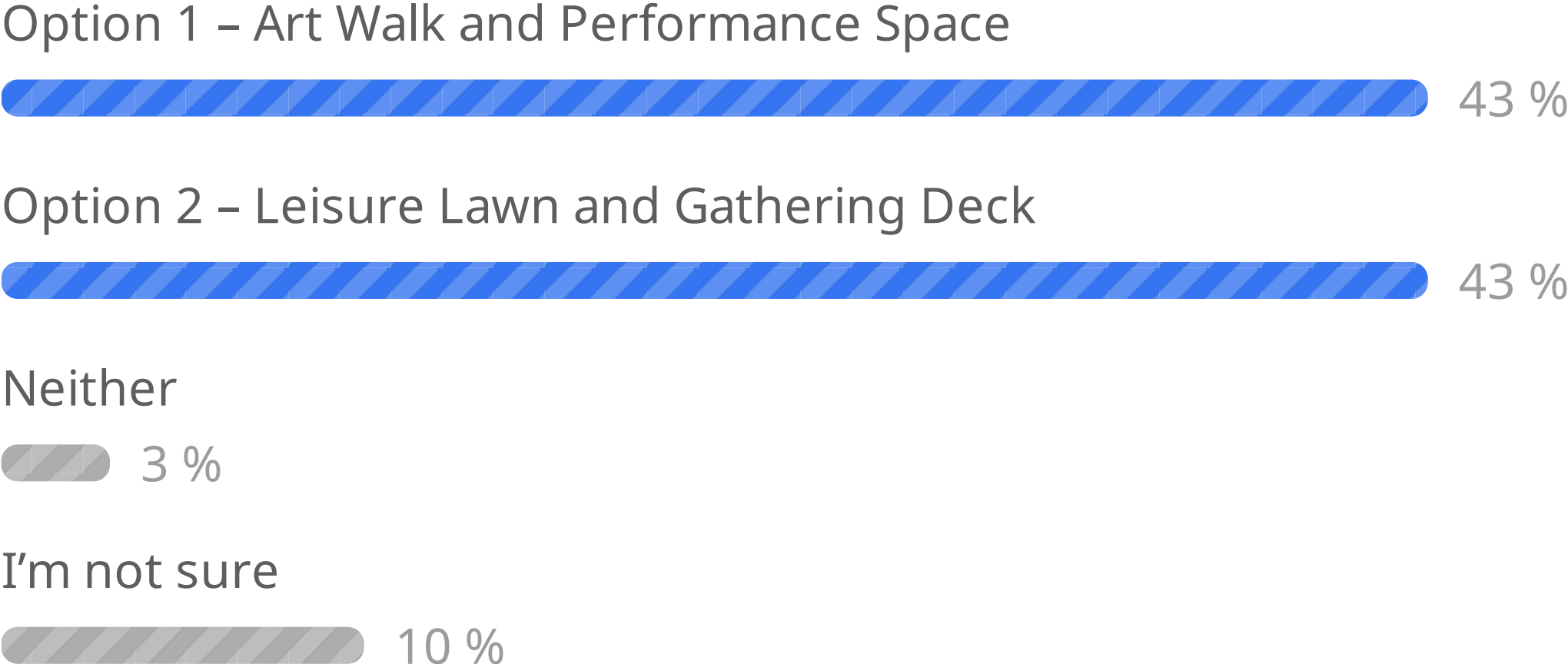

## Is there anything missing from your preferred option that you would like to see included at 24 Caller Street?

0 1 9

(1/2)

- barbecue fire pits
- coffee stand
- wifi
- Covered area for rain
- Leisure lawn is great, history is important.
- Native American history of the river.
- Connection to Main Street
- Fenced in linear grass path along the walkway for dog walkers
- Space for food trucks
- emergency call station
- no Native American History Canopy / Enclosure Lighting Public Art Tables
- Natural history River history
- Power
- Public art. Interpretive signage
- Connection to Main and Walnut Streets
- Restrooms? Group meeting space?
- Extend the landscape visually to adjoining properties (Japanese 'borrowed landscape') through design standards.
- Picnic tables
- bike lane

## Is there anything missing from your preferred option that you would like to see included at 24 Caller Street?

0 1 9

(2/2)

- performance area larger
- Connection to Main Street
- Playground items
- Both options should include public art. Ideally art that can be changed out and updated with the times.
- security cameras, security
- history



**Do you prefer the PERFORMANCE SPACE AND SEATING in Option 1 or the GATHERING DECK in Option 2?**

0 2 6

Option 1 – Performance Space and Seating



Option 2 – Gathering Deck



Neither



I'm not sure



**Do you prefer the ART WALK in Option 1 or the LEISURE LAWN and EXHIBITION CIRCLE in Option 2?**

0 2 4

Option 1 – Art Walk



Option 2 – Leisure Lawn



Neither



I'm not sure



# What activities would you frequently use the Riverwalk for?

0 2 7

(1/2)

Commute to work



Run errands or get to a destination (grocery store, coffee shop, etc.)



Walk, jog, or run



Bike



Skateboard





## What activities would you frequently use the Riverwalk for?

(2/2)

0 2 7

Pet-walking



Sit and enjoy the scenery



## Do you like the idea of Light Clusters as shown in Option 2?

0 2 4

Yes



No



I'm not sure



## What would be your primary use of the Riverwalk?

0 2 9

Active recreation (walk, bike ride, jog)



Commuting or getting to a specific destination



Passive recreation (sit, birdwatch, outdoor gathering)





Social Media Post to advertise May 20<sup>th</sup> Public Meeting

## North River Resiliency, Canal Wall, and Riverwalk Project

You're invited! The City is hosting a public meeting to discuss the North River Resiliency, Canal Wall, and Riverwalk Project. RSVP at [tinyurl.com/RiverwalkWebinar2](https://tinyurl.com/RiverwalkWebinar2) by May 18<sup>th</sup>!

#ResilientPeabody



# PEABODY RIVERWALK

Mayor Edward A. Bettencourt, Jr.

**PUBLIC MEETING  
MAY 20, 2021**



# MEETING GUIDELINES

- Please stay muted during presentation
- Questions and Comments
  - You are encouraged to leave questions in Slido, however, leaving them in the Teams video chat works too
  - We will pause periodically to address questions

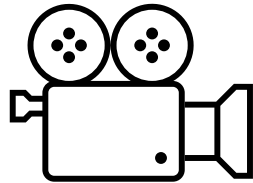

we're recording!

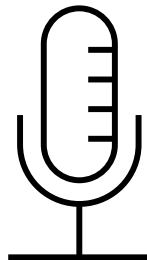

mute

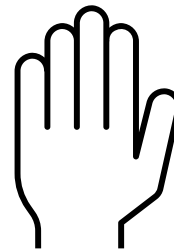

raise your hand

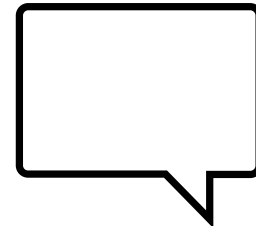

chat

*we're using Slido!*



# SLIDO

Open a web browser

Type in slido.com

Enter code: **riverwalk**

Joining as a participant?

# Enter code here

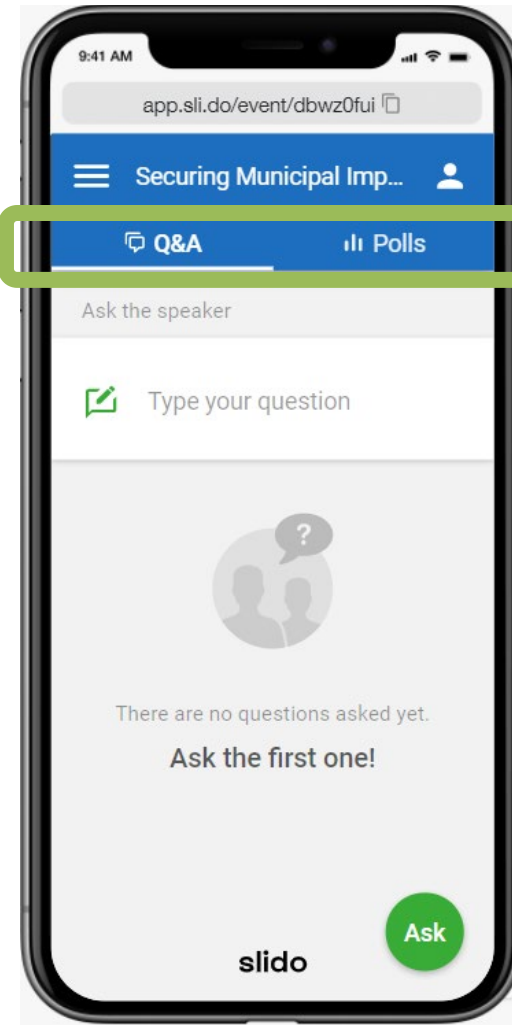

You can move between the Q&A tab and the polls tab!

slido

Did you participate in the first public meeting  
for the riverwalk?

 Start presenting to display the poll results on this slide.

slido

What are you most excited about for the riverwalk?

 Start presenting to display the poll results on this slide.



# WHO'S IN THE ZOOM



**Brendan Callahan**  
City of Peabody



**Cass Chroust**  
Weston & Sampson



**Adria Boynton**  
Weston & Sampson



**Sarah DeStefano**  
Weston & Sampson



**George Naslas**  
Weston & Sampson



# AGENDA

- **Brief Project Re-Cap**
- **Site Plan Update**
- **24 Caller Street Plan Update**
- **Polling Questions**
- **Next Steps**
- **Q & A**



# BRIEF PROJECT RE-CAP

## Downtown Corridor





# BRIEF PROJECT RE-CAP

## Resiliency Evaluation



- **Flood Mapping**
  - Current flood conditions
  - Future flood conditions under climate change
- **Potential Opportunities to Store Flood Water**
- **Evaluate Wall Options**

# PROJECT RE-CAP

## Funding

### Peabody Riverwalk Project: Unlock the Funding

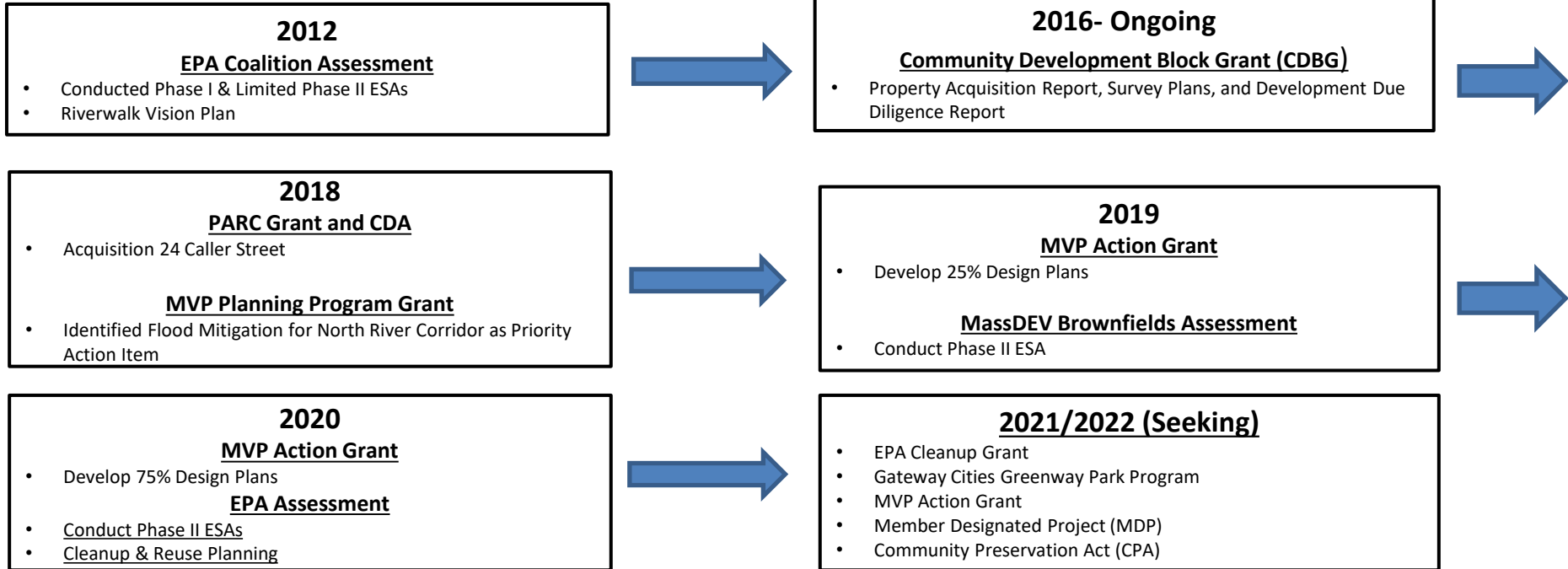

Source	City Amount	State/Federal Amount	Date
CDBG		\$243,400.00	Nov 2016-Ongoing
PARC/CDA	157,400.00	\$142,600.00	July 1, 2018- June 30, 2019
MVP Action Grant (FY19)	\$75,000.00	\$225,000.00	July 1, 2018 – June 30, 2019
MD Assessment		\$93,000.00	June 30, 2020
MVP Action Grant (FY20)	\$121,788.00	\$365,014.00	Feb 1, 2020-June 30, 2021
EPA BF Assessment Grant		\$3000,000.00	Oct 1, 2020-Sept 30, 2023
<b>Total</b>	<b>\$441,588</b>	<b>\$1,369,014</b>	<b>\$1,810,602</b>



# PROJECT RE-CAP

## Wall Analysis and Repair

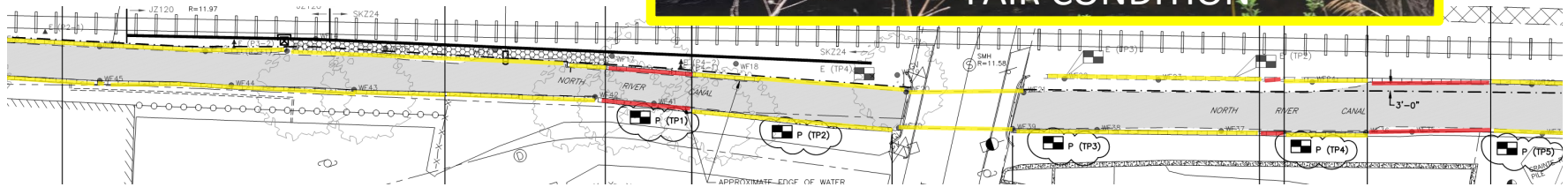



# BRIEF PROJECT RE-CAP

## Resiliency: Flood Mitigation

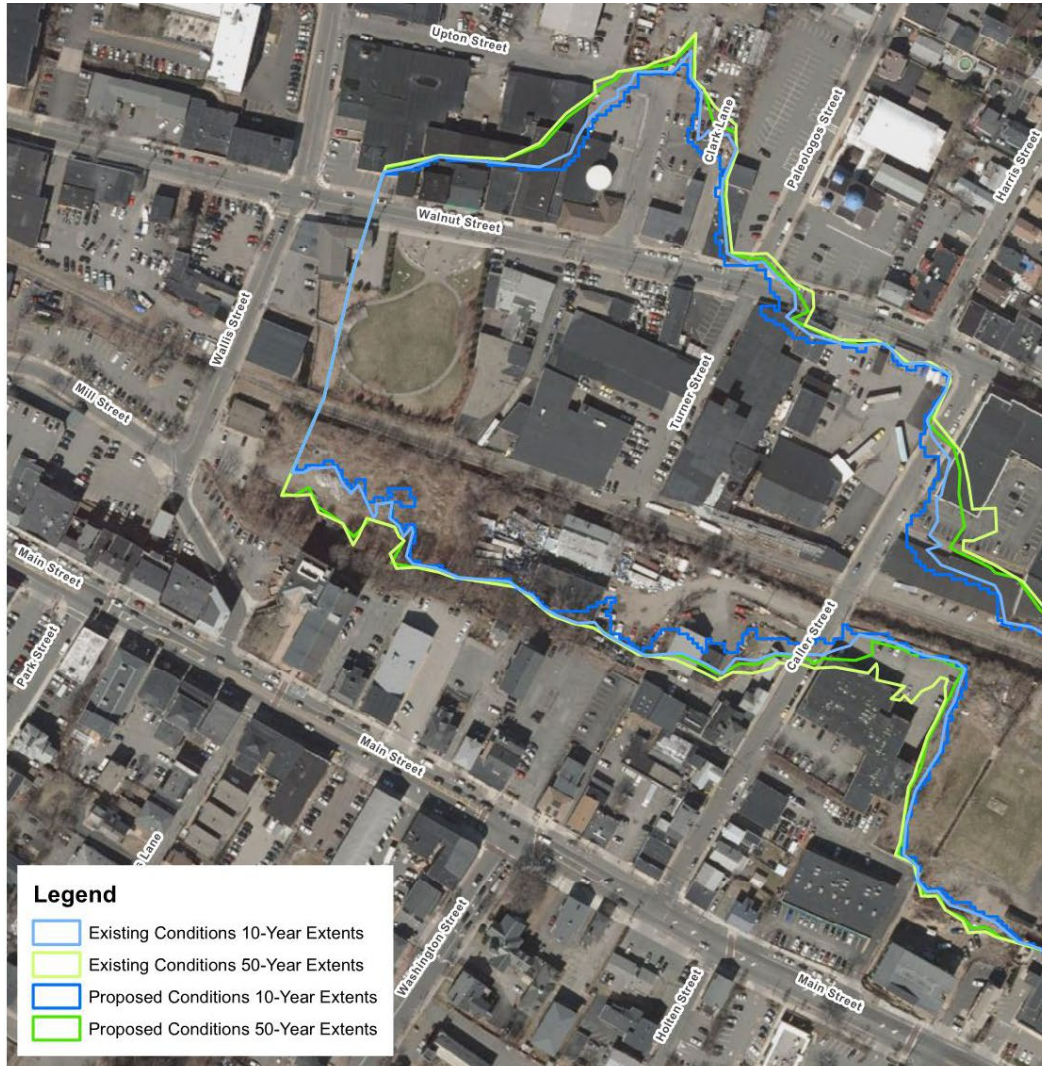

The proposed conditions would have the following impacts in the **BASELINE CLIMATE** scenario:

- Flood reductions range between 0.1 and 0.7 feet from Wallis Street to Caller Street during baseline climate
- For the two baseline flood events, reductions were limited to 0.1 feet between the railroad crossing and Grove Street

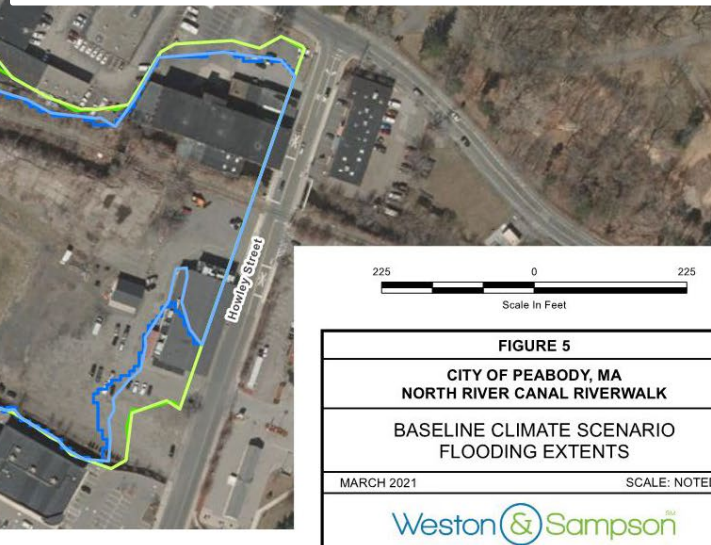



# BRIEF PROJECT RE-CAP

## Resiliency: Flood Mitigation

The proposed conditions would have the following impacts in the **2070 CLIMATE** scenario:

- During the 2070 climate scenario, flood reductions range from 0.1 to 0.5 feet between Wallis and Caller Streets during each event
- During both baseline and 2070 climate scenarios, benefits do not extend up to Peabody Square or down to Flint Street

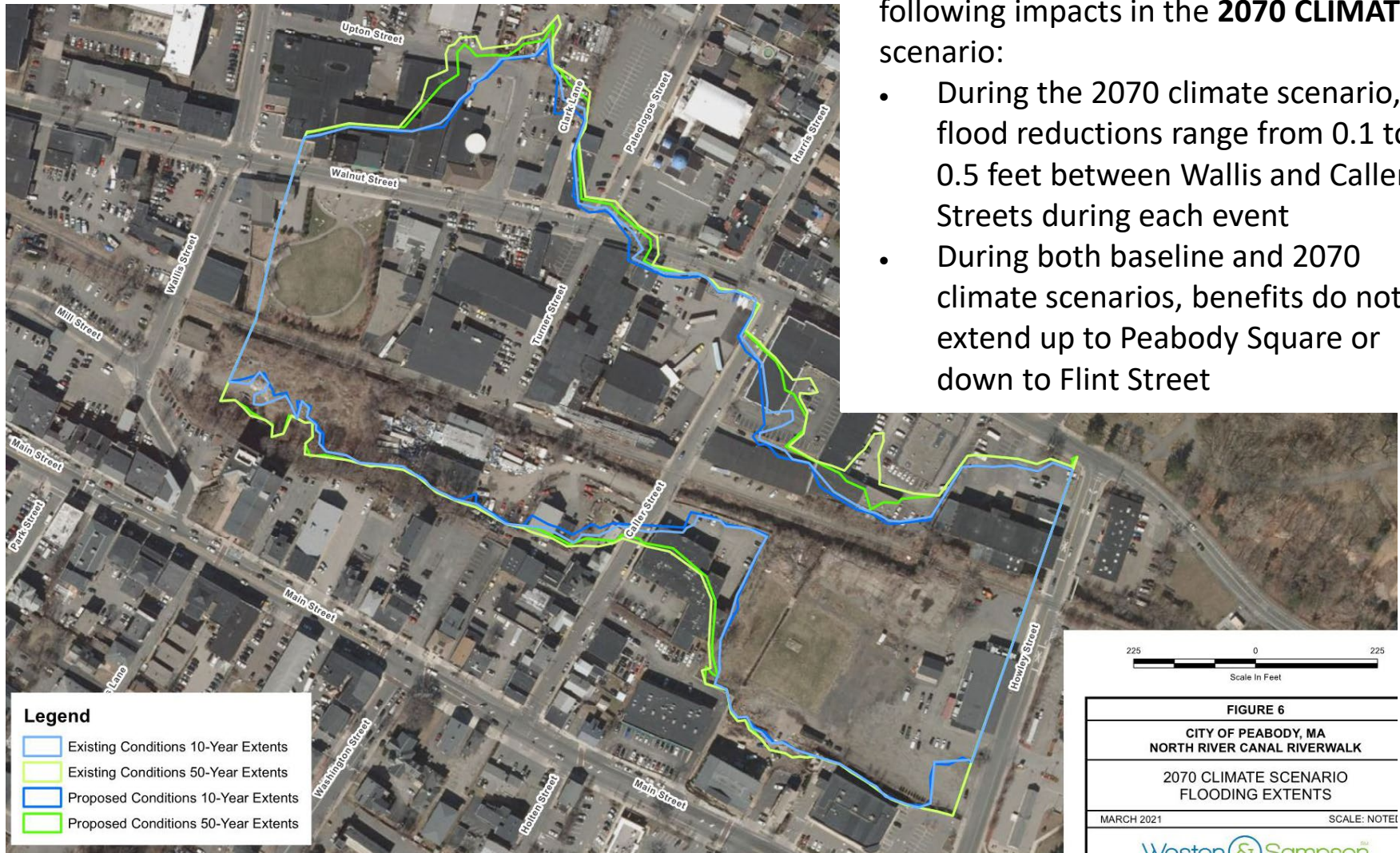



# BRIEF PROJECT RE-CAP

## Previous Plan Iteration





# BRIEF PROJECT RE-CAP

## Previous Plan Iterations

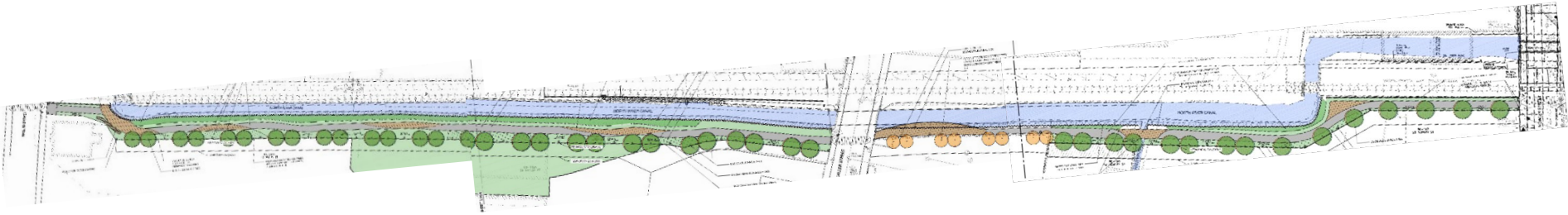

# BRIEF PROJECT RE-CAP

## Previous Public Engagement – Last Meeting: January 12, 2019

**How well does the proposed Riverwalk (excluding 24 Caller Street) meet your travel and recreation needs?** 0 2 8

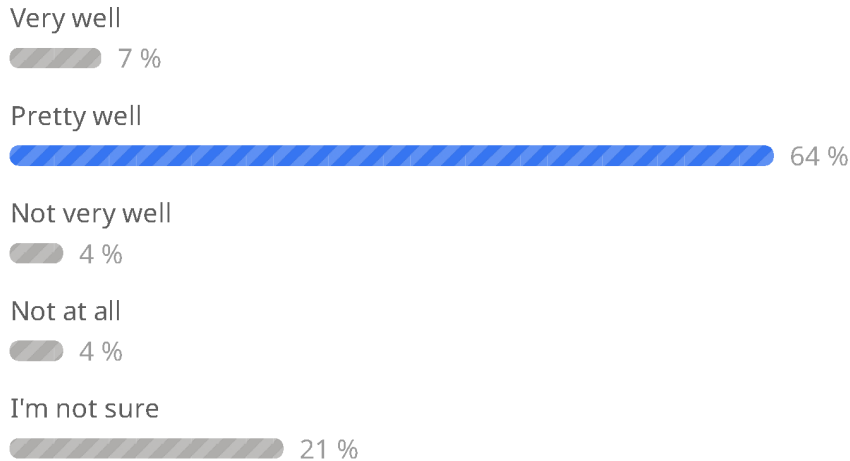

**Please select which option you like best at 24 Caller Street.** 0 3 0

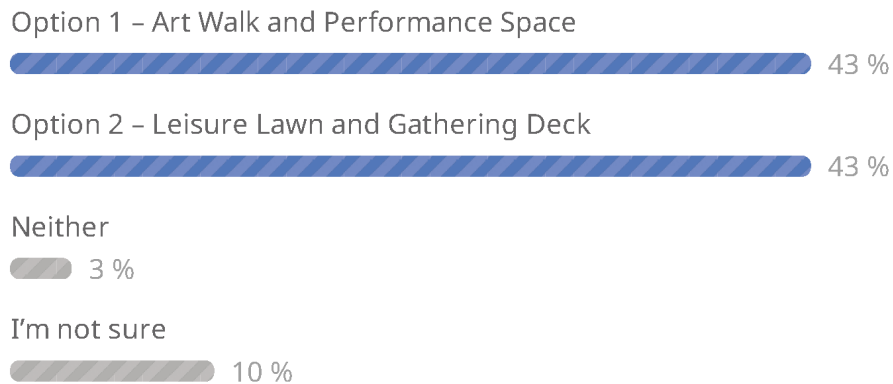

**Do you support incorporating public art along the Riverwalk?** 0 2 3



**What would you like to see more of in the proposed Riverwalk plans? (1/2)** 0 2 6

- mile markers
  - cleanup of surrounding areas
  - **Historic/interpretive markers**
  - Butterfly Waystation
  - **plantings**
  - **Small garden**
  - **Instagrammable spots :)**
  - Modern art and history
  - Water feature
  - Lighting and Peabody History
  - Interpretative markers and history
  - connection to square
  - Plantings
- Trees. Botanical signs
  - Cleanliness and safety
  - lawn space, artwork, dog area
  - **I would like more Trees and possibly a bird observation area.**
  - More open space and landscaping
  - lighting, public art, visible security
  - lots of trees
  - Lighting!
  - Swings
  - history, outdoor gym
  - Lawn space, open recreation for different program options

Lawn space  
Lighting  
Vegetation  
Instagrammable spots  
Bird observation?

# BRIEF PROJECT RE-CAP

## Previous Public Engagement – Last Meeting: January 12, 2019

Do you like the idea of Light Clusters as shown in Option 2? 0 2 4

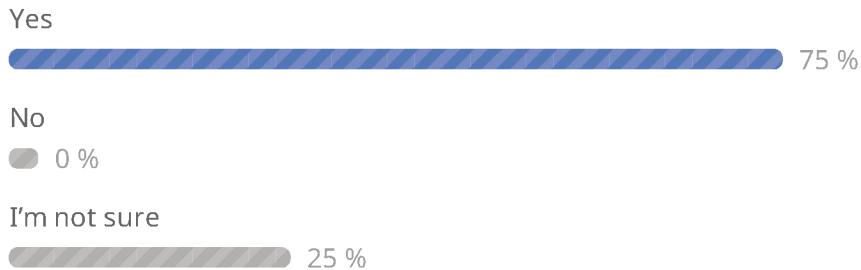

Is there anything missing from your preferred option that you would like to see included at 24 Caller Street?

(2/2)

- performance area larger
- Connection to Main Street
- Playground items
- Both options should include public art. Ideally art that can be changed out and updated with the times.
- security cameras, security
- history

Is there anything missing from your preferred option that you would like to see included at 24 Caller Street?

(1/2)

0 1 9

- barbecue fire pits
- coffee stand
- wifi
- Covered area for rain
- Leisure lawn is great, history is important.
- Native American history of the river.
- Connection to Main Street
- Fenced in linear grass path along the walkway for dog walkers
- Space for food trucks
- no
- Native American History Canopy / Enclosure Lighting Public Art Tables
- Natural history River history
- Power
- Public art. Interpretive signage
- Connection to Main and Walnut Streets
- Restrooms? Group meeting space?
- Extend the landscape visually to adjoining properties (Japanese 'borrowed landscape') through design standards.





# SITE PLAN UPDATE

## Overall Site Plan and Context



# SITE PLAN UPDATE

## Site Plan – Wallis Street

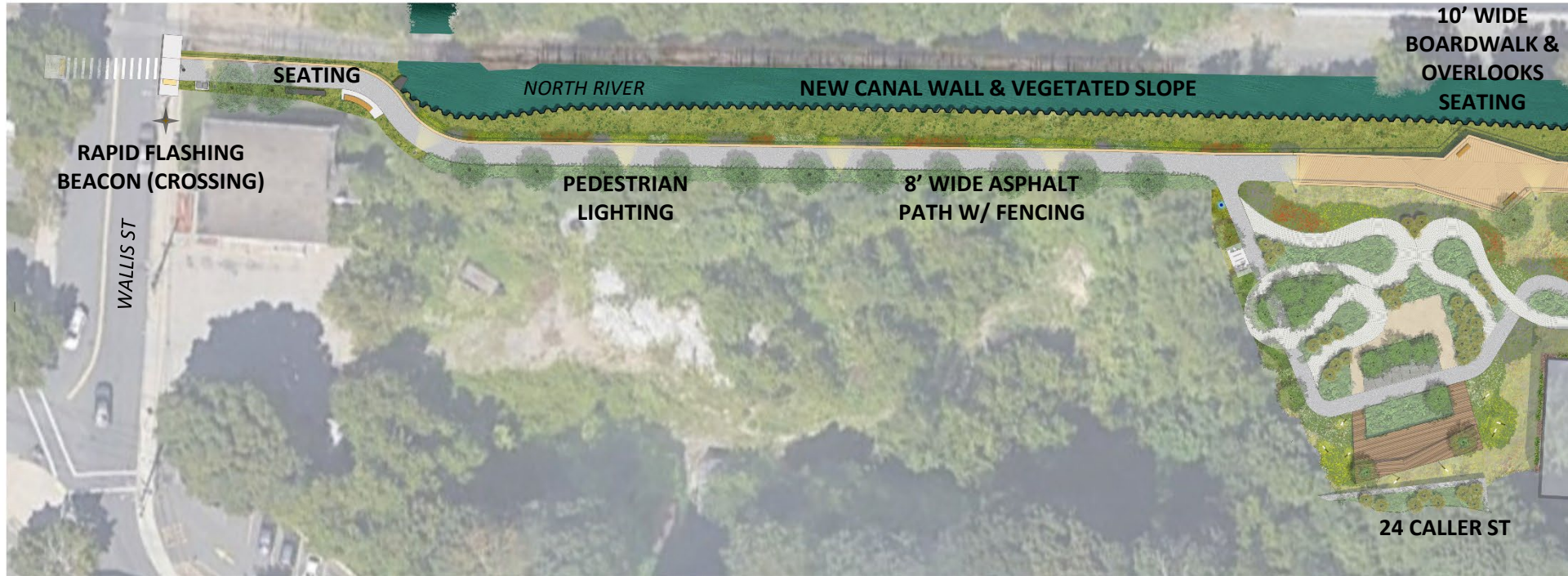

# SITE PLAN UPDATE

## Site Plan – Caller Street

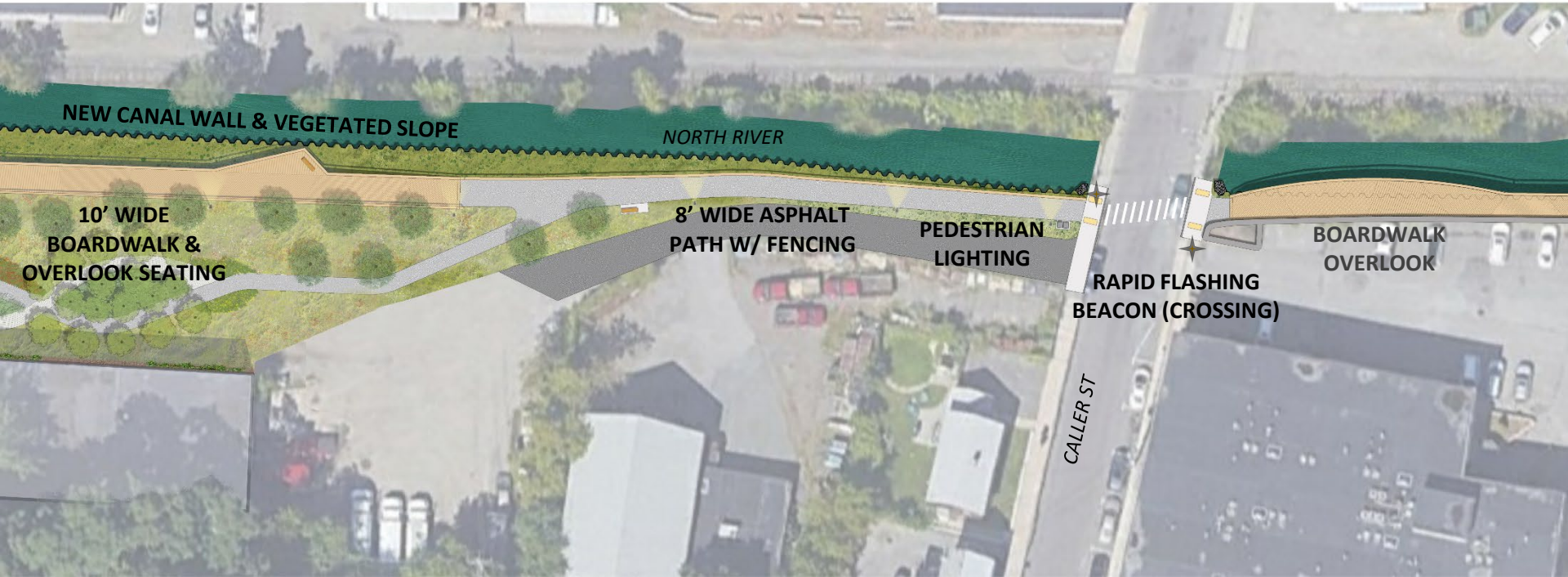



# SITE PLAN UPDATE

## Site Plan – Howley Street



# WHERE WE ARE TODAY

## 24 Caller Street Elements



- LEGEND**
- A** PAVER ART WALK
  - B** ENGRAVED GRANITE PAVERS
  - C** GATHERING DECK
  - D** RECYLCED CANAL WALL BLOCK
  - E** VERTICAL GREEN SCREEN
  - F** GRAFFITI ART WALL
  - G** WHITE BIRCH GROVE
  - H** RIVER BIRCH GROVE
  - I** LIGHT CLUSTER
  - J** STONE DUST PATIO
  -  POTENTIAL ART LOCATIONS
  -  ART GARDEN
  -  MEADOW PLANTING / NATURALIZED BUFFER





# WHERE WE ARE TODAY

## 24 Caller Street Site Plan





# WHERE WE ARE TODAY

## 24 Caller Street Perspective Illustration



slido

## What are you most excited about in the current Riverwalk design? Check all that apply.

- The improved connection in the City for pedestrians and bikers
- Improving the flood mitigation of the North River
- Creating more green open space in the City
- The boardwalks and overlooks on the North River
- The public art installations and mural wall
- The elements highlighting Peabody's unique history
- The gathering deck and light clusters

 Start presenting to display the poll results on this slide.

slido

**What are you most concerned about in the current Riverwalk design? (Not what you don't like...)**

*Write-in response...*

 Start presenting to display the poll results on this slide.



slido

**Is there anything missing from the current Riverwalk design that you would like to see included?**

*Write-in response...*

 Start presenting to display the poll results on this slide.

slido

**Is there anything you don't like in the current  
Riverwalk design?**

*Write-in response...*

 Start presenting to display the poll results on this slide.

# NEXT STEPS

- Synthesize Feedback from the Public Engagement and other Stakeholders
- Submit 75% Design Documentation for Permitting and Other Grant-related Submissions
- Apply for Additional Grant Funding
- Complete 100% Construction Documentation in FY2022 / FY2023



slido

# Audience Q&A Session

 Start presenting to display the audience questions on this slide.

# FOR MORE INFORMATION OR TO PROVIDE ADDITIONAL FEEDBACK:

**Brendan Callahan** - Asst. Director of Planning, City of Peabody  
978-538-5780

[brendan.callahan@peabody-ma.gov](mailto:brendan.callahan@peabody-ma.gov)

**Cass Chroust** - Landscape Architect, Weston & Sampson  
[chroustc@wseinc.com](mailto:chroustc@wseinc.com)

**Sarah DeStefano** – Team Leader, Weston & Sampson  
[destefanos@wseinc.com](mailto:destefanos@wseinc.com)

**George Naslas, LSP** – Vice President, Weston & Sampson  
[naslasg@wseinc.com](mailto:naslasg@wseinc.com)

THANK YOU



## Event summary report North River Resiliency, Canal Wall, And Riverwalk Project Webinar



Active users  
**6**

Engagement score **19**

Engagement per user **3.2**



Questions  
**3**

Likes / dislikes **0 / 0**

Anonymous rate **100%**



Poll votes  
**16**

Polls created **5**

Votes per poll **3**

### Popular questions

Anonymous  
today, 11:25pm 0 0

Suggest Fruit trees and community garden

Anonymous  
today, 11:26pm 0 0

is there any opportunity (space) for raised bed community garden areas?

Anonymous  
today, 11:31pm 0 0

Doggie waste stations and water drinking stations (humans and animals)

### Topics

fruit trees

water drinking stations

**community garden**

doggie waste stations humans

opportunity space animals

### Influential users

Anonymous users 3 0

# North River Resiliency, Canal Wall, And Riverwalk Project Webinar

20 - 26 May 2021

Poll results

## Table of contents

- Did you participate in the first public meeting for the Riverwalk?
- What are you most excited about for the Riverwalk?
- What are you most excited about in the current Riverwalk design? Check all that apply.
- What are you most concerned about in the current Riverwalk design?
- Is there anything missing from the current Riverwalk design that you would like to see included?



## Did you participate in the first public meeting for the Riverwalk?

004

Yes



No

0 %

Not sure

0 %

**What are you most excited about for the Riverwalk?**

0 0 4

Green space  
Revitalization of downtown  
open space  
Recreational opportunity  
Downtown Green Space

**What are you most excited about in the current Riverwalk design? Check all that apply.**

005

(1/2)

The improved connection in the City for pedestrians and bikers  
 80 %

Improving the flood mitigation of the North River  
 80 %

Creating more green open space in the City  
 40 %

The boardwalks and overlooks on the North River  
 20 %

The public art installations and mural wall  
 20 %



**What are you most excited about in the current Riverwalk design? Check all that apply.**

005

(2/2)

The elements highlighting Peabody's unique history



The gathering deck and light clusters



## What are you most concerned about in the current Riverwalk design?

002

- Safety and security
- how attractive will the river actually be?

## Is there anything missing from the current Riverwalk design that you would like to see included?

0 0 1

- Any opportunities for kayaking / boat launch



APPENDIX J

Resilience Evaluation – March 2020

# REPORT

March 2021

CITY OF  
**Peabody**  
MASSACHUSETTS

Resilient North River Canal Corridor  
Phase 2

Task 6 – Resilience Evaluation



## TABLE OF CONTENTS

	Page
TABLE OF CONTENTS .....	i
LIST OF FIGURES.....	ii
LIST OF TABLES.....	iii
EXECUTIVE SUMMARY .....	ES-1
1.0 INTRODUCTION .....	1-1
2.0 MODEL UPDATES .....	2-1
2.1 New Stormwater Retention/Detention Infrastructure.....	2-1
2.2 Windshield Survey and Watershed Spot-Check .....	2-1
2.3 Field Survey .....	2-1
3.0 MODEL CALIBRATION .....	3-1
3.1 Rainfall Data.....	3-1
3.2 Historical Flood Level Data .....	3-2
3.3 Calibration Results .....	3-2
4.0 DESIGN EVENTS .....	4-1
4.1 Baseline Climate Rainfall .....	4-1
4.2 Future Climate Rainfall.....	4-2
4.3 Baseline and Future Tide Data .....	4-3
5.0 25% WALL DESIGN EVALUATION.....	5-1
6.0 FLOOD STORAGE EVALUATION .....	6-1
7.0 75% WALL DESIGN EVALUATION.....	7-1
8.0 CONCLUSION .....	8-1
9.0 REFERENCES .....	9-1



## LIST OF FIGURES

Figure 1..... Watershed Spot-Check Locations

Figure 2..... Site Map

Figure 3..... Rainfall Data on March 13-15, 2010 in Beverly, MA

Figure 4..... Model Calibration Locations

Figure 5..... Baseline Climate Scenario Flooding Extents

Figure 6..... 2070 Climate Scenario Flooding Extents

LIST OF TABLES

Table 1 ..... Updated Model Calibration Results (March 13-15, 2010 Event)

Table 2 ..... NOAA14 Design Rainfall Depths

Table 3 ..... Estimated 2070 Design Rainfall Depths

Table 4A.....Reduction in Flood Elevations due to 25% Wall Design under a Baseline Climate

Table 4B..... Reduction in Flood Elevations due to 25% Wall Design under a 2070 Climate Scenario

Table 5A.....Reduction in Flood Elevations due to Additional Flood Storage  
under a Baseline Climate

Table 5B.....Reduction in Flood Elevations due to Additional Flood Storage  
under a 2070 Climate Scenario

Table 6A.....Reduction in Flood Elevations due to 75% Wall Design under a Baseline Climate

Table 6B..... Reduction in Flood Elevations due to 75% Wall Design under a 2070 Climate Scenario

## EXECUTIVE SUMMARY

Weston & Sampson conducted a Resilience Evaluation during the Preliminary Design Phase of the Peabody North River Canal Resilient Wall, Riverwalk, and Park Project. The preliminary analyses contributed to the selection of a preferred wall alternative. However, those analyses focused solely on general flooding patterns within the study area from Wallis Street to Howley Street in the City and did not include a detailed assessment of either the drainage area (both upstream and downstream) or of the hydraulics of the North River Canal.

More detailed hydrologic and hydraulic (H&H) analyses were conducted during this current phase of the North River Canal project. The City's existing H&H model was updated in several ways, including a review of recent stormwater detention/retention projects in the North River watershed, a windshield survey and spot-check of the size of key culverts and pond outlets, a more detailed representation of the Canal and its floodplain based on a May 2020 survey that included both topographic and bathymetric elements, and finally the inclusion of updated design rainfall events based on the best available design rainfall and tidal data for both baseline and 2070 climate conditions. After these updates, the model was recalibrated against historical observations from the March 2010 flood event to ensure its continued accuracy and usefulness in evaluating changes to the North River Canal.

The updated model was then used to evaluate the potential reductions in peak flood elevations considering the proposed 25% Design of the preferred wall alternative. Model results suggest that the proposed wall design could result in peak flood elevation reductions of 0.4 to 1.2 feet in the area between Wallis Street and just downstream of Caller Street during the 10- to 100-year events under a baseline climate. Benefits are not expected to extend as far downstream as Howley Street as the hydraulics in that area are controlled by the tidal influence of Salem Harbor. Peak flood elevation reductions between Wallis Street and Caller Street are expected to be somewhat reduced by 2070, generally ranging from 0.3 to 0.8 feet. Model results also indicate that the proposed wall design is not expected to result in significant flood elevation changes either upstream in Peabody Square or downstream in Salem.

The updated model was also used to evaluate the potential benefits of creating additional flood storage in three specific parcels near the study area. Based on the model results discussed in this section, creating additional flood storage at 13 Wallis Street and 24 Caller Street could provide modest reductions in peak flood elevations under a wide range of design storms and under both baseline and 2070 climate scenarios, generally 0.1 to 0.5 feet. Benefits would likely be localized to the reach of the North River Canal from Wallis Street to Caller Street. No significant change is expected upstream near Peabody Square or downstream in Salem.

Finally, the updated model was used to evaluate the 75% Design of the preferred wall alternative, which included modest additional flood storage on the 24 Caller Street parcel. Results from the updated model show potential peak flood elevation reductions between 0.1 and 0.7 feet in the area between Wallis Street and just downstream of Caller Street during the 10- to 100-year events under a baseline climate. By 2070 the peak flood elevations may be reduced by 0.1 to 0.3 feet during the 10- to 100-year events. Limited flood reduction is expected downstream of Caller Street.



## 1.0 INTRODUCTION

Weston & Sampson conducted a Resilience Evaluation during the Preliminary Design Phase of the Peabody North River Canal Resilient Wall, Riverwalk, and Park Project. The methodology and results of the analyses were included in Weston & Sampson's March 2019 report titled "Resilience Evaluation Report." The preliminary analyses focused on the potential changes to flood elevations and flooding impacts under future climate scenarios, as well as on the potential benefit of the selected wall alternatives and the creation of near-river flood storage. These analyses contributed to the selection of a preferred wall alternative. The preliminary analyses, however, focused solely on flooding patterns within the study area from Wallis Street to Howley Street in the City and did not include a detailed hydrologic analysis of the drainage area (both upstream and downstream), as well as hydraulic analysis of potential changes to the geometry of the North River Canal.

The current phase (Phase II) of this Project included a detailed hydrologic and hydraulic (H&H) study, which included:

1. Updating the City's existing H&H model, which we understand was last significantly updated in 2008 or 2009;
2. Re-calibrating the model to ensure its continued accuracy and usefulness in the study area;
3. Simulating site-specific flooding from design storm events under both baseline and future climate scenarios;
4. Employing the updated and calibrated H&H model to support design of the preferred wall alternative; and
5. Evaluating the potential benefits of creating additional flood storage on three parcels adjacent to the North River Canal using the updated model.

Each of these sub-tasks is described in the following sections.

## 2.0 MODEL UPDATES

Weston & Sampson updated the City's existing H&H model of the North River watershed and Canal to reflect recent changes in river crossings, channel geometry, and upgradient storage. The City's existing North River H&H model was first developed by Metcalf & Eddy, now AECOM, in 2003 using PC-SWMM version 4. The model was updated to run on PC-SWMM version 5 in 2008. It was revised and recalibrated at that time against data obtained during the May 2006 "Mother's Day" event among others, as described in an April 2008 report<sup>1</sup>. Weston & Sampson understands that between 2008 and 2011/2012, the model was repeatedly used to evaluate potential projects to mitigate flooding in the Peabody Square area, and that the version of the model provided to Weston & Sampson accurately reflects hydrologic and hydraulic conditions in the North River watershed and canal in 2008.

Weston & Sampson obtained a copy of the City's H&H model from AECOM in the spring of 2020 and proceeded to update broken links to other related input files to the model, which frequently occur during a model transfer. We then updated the North River H&H model to reflect any significant changes in the watershed and river channel. Three types of changes were based on the following considerations described below.

### 2.1 New Stormwater Retention/Detention Infrastructure

Weston & Sampson conducted a phone meeting with City staff, Brendan Callahan and William Paulitz, on April 22 to discuss the creation of any significant stormwater retention/detention facilities upstream in the North River watershed that might reduce peak flows to the project area. Brendan and Will identified five new stormwater detention/retention projects, associated with commercial developments, that were constructed after 2011, and provided drawings of and/or supporting calculations for four of those five projects. Weston & Sampson reviewed that documentation and updated sub-basin storage parameters in the model, as necessary.

### 2.2 Windshield Survey and Watershed Spot-Check

Weston & Sampson conducted a windshield survey of the North River watershed to identify further recent projects that might affect the hydrology and runoff patterns of the watershed. In addition, we measured the dimensions of pond outlets and culvert crossings at approximately one dozen locations, as shown in Figure 1, that could have a significant impact on runoff routing in the model. In all cases, field measurements closely matched how those structures were already incorporated into the existing model so no changes were made to the model.

### 2.3 Field Survey

Weston & Sampson also conducted a detailed survey of the project area, which included the survey of 15 cross-sections across the North River canal in order to more accurately represent the North River Canal in and near the study area, as shown in Figure 2. The surveyed cross-section locations extended from 40 feet upstream of Wallis Street to 360 feet downstream of Howley Street. The original model represented the North River Canal with five open conduits. Weston & Sampson updated the model to

---

<sup>1</sup> Metcalf & Eddy and AECOM. April 2008. "Preliminary Design of Flood Mitigation Facilities for Peabody Square Area."

represent that same reach with a series of 13 conduits, where each conduit was located with one of the surveyed cross-sections near its center.

\\wse03.local\WSE\Projects\MA\Peabody MA\MVP Action Grant 2019\Task 6 - Resilience\Report\North River Phase II Resilience Evaluation Report Revised.docx

.....



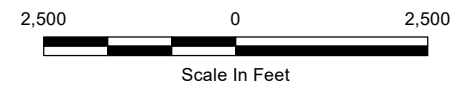
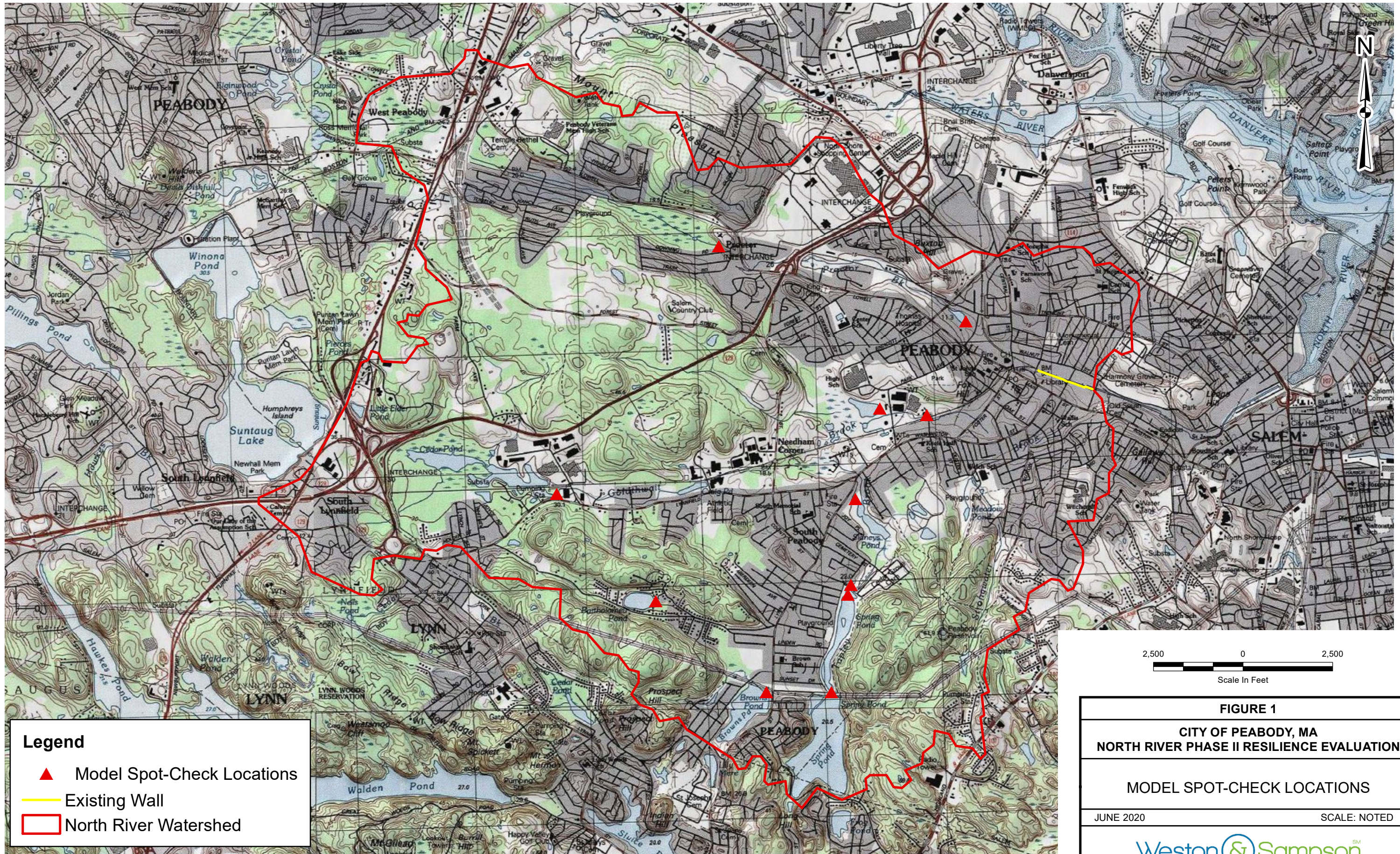

**Legend**

- ▲ Model Spot-Check Locations
- Existing Wall
- North River Watershed

<b>FIGURE 1</b>	
<b>CITY OF PEABODY, MA</b>	
<b>NORTH RIVER PHASE II RESILIENCE EVALUATION</b>	
<b>MODEL SPOT-CHECK LOCATIONS</b>	
JUNE 2020	SCALE: NOTED





**Legend**

- Survey Cross-Sections
- Existing Wall Location
- Potential Flood Storage Sites

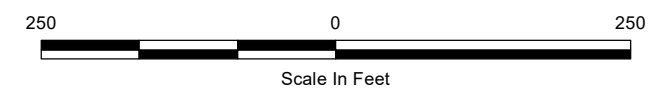

<b>FIGURE 2</b>	
<b>CITY OF PEABODY, MA</b>	
<b>NORTH RIVER PHASE II RESILIENCE EVALUATION</b>	
<b>SITE MAP</b>	
JUNE 2020	SCALE: NOTED



### 3.0 MODEL CALIBRATION

To ensure that the H&H model, updated to reflect recent changes in the North River watershed and canal, remained accurate within the study area, Weston & Sampson calibrated the updated model based on rainfall and flooding observations from the March 2010 flood event, which caused significant flooding in the Peabody Square area. As the version of the original model that was provided to Weston & Sampson appeared to reflect hydrology of the North River watershed and hydraulics of the Canal as they were in 2008, the selection of a more recent historical flood event allows us to independently calibrate the model after making significant updates. In addition, Weston & Sampson was hired by the City to survey flood levels during the event, providing an unusually detailed dataset against which to compare simulated flood levels.

#### 3.1 Rainfall Data

Rainfall data used to drive that calibration simulation were derived from historical observations recorded at hourly intervals between March 13th and 15th, 2010 at the NOAA gaging station in Beverly, WBAN-54733, as accessed from the National Climatic Data Center’s website. As shown in Figure 3 below, approximately 7.75 inches of rain fell over the 72-hour period between March 13-16, 2010 with hourly intensities ranging from approximately 0.05 to 0.45 inches per hour. Approximately 7.28 inches of rain fell during the peak 48 hours of the event (5:00 pm on 3/13 through 5:00 pm on 3/15), which is approximately equivalent to a 25-year rainfall event according to the latest design rainfall guidance documents for New England.

Figure 3: Rainfall on March 13-15, 2010 in Beverly, MA

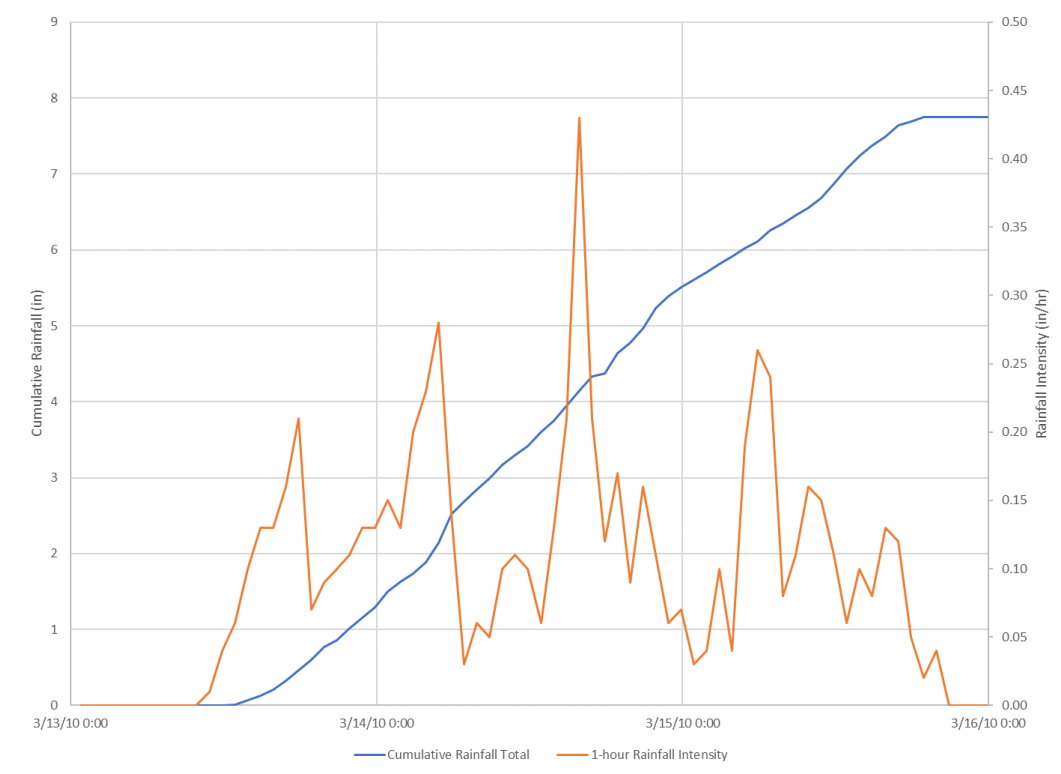



### 3.2 Historical Flood Level Data

Weston & Sampson was contracted by the City of Peabody in November of 2009 to finalize and deliver a base map for the North River Expansion Project. As part of that contract, we also performed additional services at the request of the City to identify flood elevations during the March 2010 storm event. Those services included two days of field survey to delineate the limits and depths of flooding. Figure 4 shows the location of these survey points as red dots, while the yellow lines indicate the modeled representation of the North River, its tributaries, culverts and bridges, and the conduits that convey those waterbodies beneath Peabody Square and other portions of downtown Peabody.

Figure 4: Model Calibration Locations

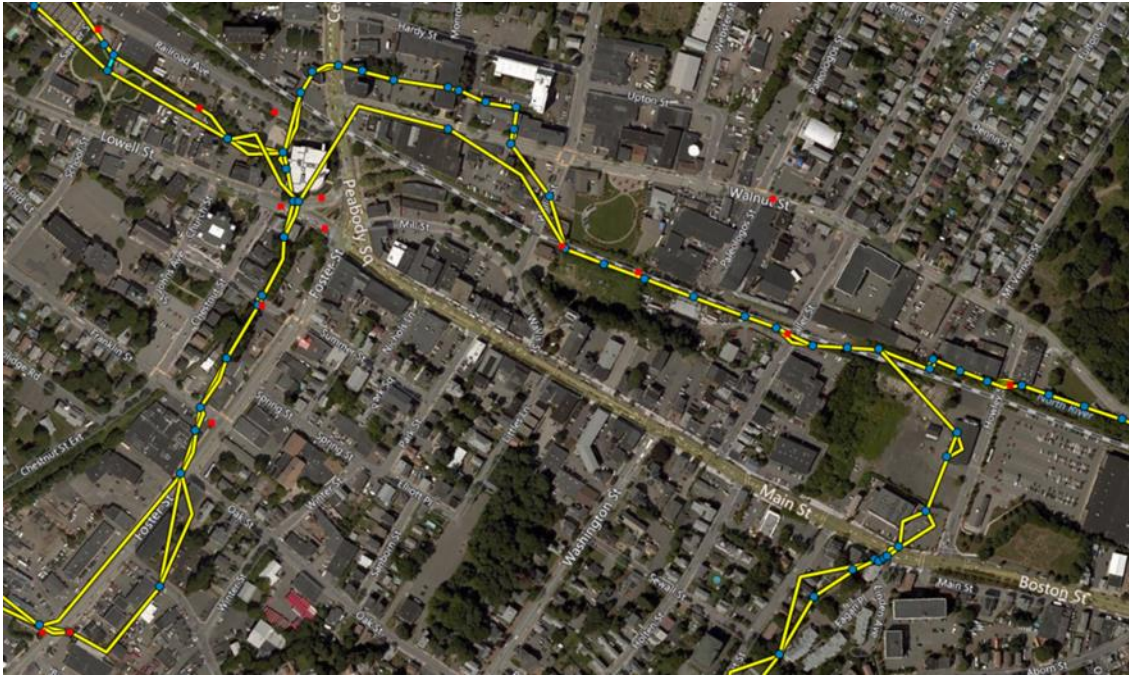

Red dots indicate survey flooding locations on March 15, 2010. Yellow lines indicate modeled rivers/brooks.

### 3.3 Calibration Results

A comparison of simulated versus observed flood elevations at four locations within the study area as well as two locations a short distance upstream, one each on the North River's two primary tributaries, Proctor Brook and Goldthwaite Brook, is summarized in Table 1.

As shown in Table 1, flood elevations in the North River Canal in the study area are calibrated very well, to within approximately a quarter of a foot. The fact that for the two most downstream calibration points, Howley Street and Crawley Street, the difference between the observed and modeled flood elevations are greater than the other North River points further upstream suggests that the tide data used in the calibration simulation may be the issue. The tidal dataset used during the calibration simulation was derived from historical observations recorded at 6-minute intervals by NOAA's Boston Harbor gage (#8443970). While the downstream limit of this H&H model, Salem Harbor, is relatively close to Boston Harbor, small differences in tide elevations could be causing the 0.25- to 0.30-foot differences that are being observed near the downstream end of the study area.

Table 1: Updated Model Calibration Results (March 13-15, 2010 Event)

Location	Flood Elevations (ft. NGVD29)		Difference (ft.)
	Model	Survey	
North River, downstream face of Howley St.	9.86	9.61	-0.25
North River, upstream face of Caller St.	12.71	12.41	-0.30
North River, D/S edge of Memorial Park	13.54	13.65	0.11
North River, U/S edge of Memorial Park	14.56	14.51	-0.05
Proctor Brook, downstream face of Sayer St.	22.00	22.16	0.16
Goldthwaite Brook, upstream face of Church St.	23.12	22.45	-0.67

The other difference worth noting is the calibration point on Goldthwaite Brook, where the flood elevation was predicted by the H&H model to be 0.67 feet higher than was observed from field measurements during the event. This difference is typical of other comparisons made further upstream on Goldthwaite Brook, suggesting that the way the model is simulating runoff from the Goldthwaite Brook watershed may be overestimating runoff volumes and/or peak runoff rates. However, adjusting the model to correct this systemic issue is beyond the scope of this project, and, regardless, Table 1 highlights how well calibrated the model is for the study area. This updated H&H model can be reliably used to evaluate potential changes in flooding characteristics under existing conditions as well as under proposed conditions with the wall design associated with the current project.

## 4.0 DESIGN EVENTS

In addition to updating the physical representation of the North River Canal based on survey data gathered in support of this project (Phase II), Weston & Sampson also updated the City's H&H model to include ten new design storm events, five under a baseline climate similar to present day and five under potential 2070 climate conditions. These ten events are listed here, and their associated input parameters are described in detail in the following sub-sections.

1. Baseline climate, 10-year, 24-hour event with normal tides
2. Baseline climate, 25-year, 24-hour event with normal tides
3. Baseline climate, 50-year, 24-hour event with normal tides
4. Baseline climate, 100-year, 24-hour event with normal tides
5. Baseline climate, 10-year, 24-hour event with current 1% storm tide (storm surge + tide) event equivalent to that observed during Winter Storm Grayson in January 2018
6. Potential 2070 climate, 10-year, 24-hour event with normal tides by 2070
7. Potential 2070 climate, 25-year, 24-hour event with normal tides by 2070
8. Potential 2070 climate, 50-year, 24-hour event with normal tides by 2070
9. Potential 2070 climate, 100-year, 24-hour event with normal tides by 2070

Potential 2070 climate, 10-year, 24-hour event with a 1% (annual probability) coastal storm event (storm surge + tide) by 2070

### 4.1 Baseline Climate Rainfall

At the time the City's model was updated from PC-SWMM version 4 to version 5 in 2008, design rainfall depths for H&H analyses in New England were generally derived from the Soil Conservation Service's Technical Paper #40 (TP-40). Between 2008 and 2011, it became common practice to use updated design rainfall depths based on the Cornell-Northeast Regional Climate Center collaboration. However, since that time, NOAA has published Atlas 14: Precipitation-Frequency Atlas of the United States for Stormwater Management. NOAA Atlas 14 provides design rainfall depths for events with durations ranging from 5 minutes to 60 days and with recurrence intervals ranging from 1 year to 1000 years.

Given the size of the North River watershed, the level of development within the watershed, and the intended use of the model, Weston & Sampson elected to use 24-hour durations on all design events for this project. The NOAA Atlas 14 design rainfall depths associated with 10-, 25-, 50-, and 100-year, 24-hour events centered on the project area are presented in Table 2 along with their now outdated TP-40 counterparts.

**Table 2: NOAA14 Design Rainfall Depths**

Recurrence Interval (years)	Design Rainfall Depth (inches)	
	NOAA Atlas 14	TP-40
10	5.1	4.5
25	6.2	5.4
50	.07	5.9
100	8.0	6.5

These NOAA Atlas 14 values represent the industry-standard design rainfall depths for events under a late-1900s/early 2000s (baseline) climate condition. In addition to the total rainfall depths associated with these events, as shown in Table 2, and the 24-hour event duration, the design rainfall events



developed for this project were defined by a time increment and by the distribution of the rainfall data over time. The distribution of the total rainfall depth over time was defined from SCS Type III distributions.

The time increment selected for this project was 6 minutes, which is relatively short but appropriate for the urbanized study area of the project. Longer time increments would run the risk of minimizing some of the flashiness of some of the smaller, more highly developed sub-basins within the model. In small basins, short time increments can overemphasize peak runoff rates, but given the size of the North River watershed, the flow rates simulated in the study area will not be affected by this issue.

#### 4.2 Future Climate Rainfall

To determine the future design storm depths for Peabody, the latest available downscaled climate change projections were used from the Localized Constructed Analogs (LOCA) dataset, which is the same dataset that has been used for ResilientMA.org and the State's Hazard Mitigation and Climate Adaptation Plan. Future 24-hour design storms for the 10-, 25-, 50- and 100-year recurrence intervals were determined by fitting an extreme value distribution to future daily precipitation projections from 14 global climate models for multiple emissions scenarios using a 30-year averaging period around the 2070 planning horizon (2056-2085). The percent increase in the precipitation depths between the modeled baseline and the modeled future 2070 period for each recurrence interval were then applied to the respective NOAA Atlas 14 median values for locational bias correction to estimate the future precipitation design storm depths for Peabody. Those calculated values for a 2070 climate scenario and their respective increase over baseline counterparts are presented in Table 3.

**Table 3: Estimated 2070 Design Rainfall Depths**

Recurrence Interval (years)	Design Rainfall Depth (inches)		Expected Increase (%)
	NOAA Atlas 14	Estimated 2070 Values	
10	5.1	5.8	15
25	6.2	7.3	17
50	7.1	8.4	19
100	8.0	9.7	20

As shown in Table 3, total 24-hour rainfall depths in 2070 are estimated to increase by 15 to 20% compared to baseline values for the same 10-year to 100-year storm recurrence intervals.

### 4.3 Baseline and Future Tide Data

Previous reports have indicated that the tidal influence of Salem Harbor regularly extends into the project area during high tide, approximately a couple hundred feet upstream of Howley Street. During more extreme tidal conditions, this tidal influence can extend upstream towards Caller Street. Therefore, the ten design events incorporated into City's H&H model for this project, specifically include dynamic tidal cycles that make use of the latest NOAA tide data to estimate baseline climate tidal conditions and projections for sea level rise and storm surge to estimate the 2070 storm tidal conditions using the latest Statewide Massachusetts Coastal Flood Risk Model (MC-FRM) that is being developed by MassDOT and will be the Statewide standard model to evaluate coastal flooding impacts across the Commonwealth.

As indicated in the beginning of Section 4, four of the five baseline climate events incorporated into the model are associated with "normal" tidal conditions. Dynamic normal tidal elevations under both baseline and 2070 climate scenarios were obtained from MC-FRM developed by the Woods Hole Group. The MC-FRM is a hydrodynamic coastal flood model based on ADCIRC, which simulated tens of thousands of historical and hypothetical storms to generate probability of flooding, flood elevations, flood extents, and dynamic flood elevations under regular tide at different points along the model domain. The dataset consisted of 30 days' worth of 15-minute tide level estimates in Salem Harbor. Weston & Sampson selected a 48-hour period within that 30-day tidal dataset so that the highest high tide roughly coincided with the peak runoff resulting from the 24-hour 100-, 50-, 25-, and 10-year design events under a baseline climate scenario. The fifth baseline climate simulation, a 10-year flood, was defined to occur during an extreme tidal event causing storm surge into the project area. Those storm surge conditions were represented by tidal observations made by NOAA gage #3443970 in Boston Harbor during Winter Storm Grayson in January 2018. Again, the tide data window was selected so that the peak storm surge coincided roughly with peak runoff from the North River watershed.

Tidal conditions for design events under a 2070 climate scenario were modeled similarly. Dynamic storm tidal elevations for the 1% (100-year) storm event under both present and 2070 climate scenarios were obtained from MC-FRM developed by the Woods Hole Group. Again, the 48-hour period of storm tidal data was selected so that the peak storm tidal elevation occurs at roughly the same time as peak runoff from the North River watershed. The fifth future climate scenario, a 10-year 24-hour rainfall design storm event with 1% coastal storm tidal event by 2070 was developed to include estimates flood impacts under this type of joint occurrence of heavy rainfall and storm surge conditions.

By defining the downstream boundary condition of the North River H&H model with these dynamic tidal datasets, we are able to evaluate flooding and other hydraulic characteristics in the North River in a way that takes into account the influence of Salem Harbor. In addition, as previous studies have indicated that sea level rise will likely cause tidal influences to extend well into the project area, this approach allows the model to evaluate the reductions in hydraulic capacity and instream storage that are associated with that sea level rise and future storm conditions.

## 5.0 25% WALL DESIGN EVALUATION

Weston & Sampson developed an alternative model geometry to represent the 25% Design of the preferred wall alternative. The model was used to evaluate changes in flooding within the 1,600-foot-long project site as well as upstream near Peabody Square and downstream in Salem. The impacts of the preferred wall design on peak flood elevations at key locations along the project site, upstream near Peabody Square and downstream in Salem under baseline climate and 2070 climate scenarios are presented below in Tables 4A and 4B, respectively.

**Table 4A: Reduction in Peak Flood Elevations due to 25% Wall Design under a Baseline Climate**

Location	100-yr	50-yr	25-yr	10-yr	10-yr with Storm Surge
Goldthwaite at Main	0.0	0.0	0.0	0.0	0.0
Goldthwaite at Church	0.0	0.0	0.0	0.0	0.0
Proctor at Fire Station	0.0	0.0	0.0	0.0	0.0
North River downstream of Wallis	0.4	0.4	0.5	0.6	0.6
North River at Memorial Park	0.4	0.4	0.4	0.6	0.6
North River at Paleologos	0.7	0.8	0.9	1.2	1.1
North River upstream of Caller	0.4	0.4	0.4	0.7	0.5
North River downstream of Caller	0.7	0.7	0.7	0.7	0.6
North River upstream of RR	0.0	0.0	0.0	0.0	0.0
North River downstream of RR	0.0	0.0	0.0	0.0	0.0
North River upstream of Howley	0.0	0.0	0.0	0.1	0.0
North River downstream of Howley	0.0	0.0	0.0	0.0	0.0
North River upstream of Grove	0.0	0.0	0.1	-0.1	0.0
North River upstream of Flint	0.0	0.0	0.0	0.0	0.0

**Table 4B: Reduction in Peak Flood Elevations due to 25% Wall Design under a 2070 Climate Scenario**

Location	100-yr	50-yr	25-yr	10-yr	10-yr with Storm Surge
Goldthwaite at Main	0.0	0.0	0.0	0.0	0.0
Goldthwaite at Church	0.0	0.0	0.0	0.0	0.0
Proctor at Fire Station	0.0	0.0	0.0	0.0	0.0
North River downstream of Wallis	1.8	0.4	0.4	0.5	0.4
North River at Memorial Park	2.0	0.4	0.4	0.5	0.4
North River at Paleologos	2.6	0.6	0.7	0.8	0.5
North River upstream of Caller	2.7	0.3	0.3	0.4	0.2
North River downstream of Caller	2.8	0.4	0.4	0.6	0.2
North River upstream of RR	0.0	0.0	0.0	0.0	0.0
North River downstream of RR	0.0	0.0	0.0	0.0	0.0
North River upstream of Howley	0.0	0.0	0.0	0.1	0.0
North River downstream of Howley	0.0	0.0	0.0	0.1	0.0
North River upstream of Grove	0.0	0.0	0.0	0.0	0.0
North River upstream of Flint	0.0	0.0	0.0	0.0	0.0



The proposed wall design would increase the hydraulic capacity of the North River Canal from Wallis Street to Caller Street and from Caller Street to the railroad crossing just upstream of Howley Street. As shown in Tables 4A and 4B, these improvements result in modest reductions of peak flood elevations from Wallis Street down to just downstream of Caller Street. The reduction ranges from 0.4 to 1.2 feet under a baseline climate, depending on the precise location and the design event, with smaller storms, such as the 10- and 25-year events experiencing slightly greater benefits. Flood reductions do not reach as far downstream as the railroad crossing and Howley Street as that area is primarily controlled by tidal influences extending upstream from Salem Harbor.

A similar pattern emerges under the 2070 scenario with reductions in peak flood elevations generally ranging from 0.3 to 0.8 feet in the area between Wallis and Caller Streets during events ranging from the 10-year to the 50-year floods.

In both baseline and 2070 climate scenarios, model results indicate that the benefits of the wall design do not extend up into Peabody Square, nor are conditions worsened downstream on the North River in Salem. The benefits of widening the North River Canal are likely localized due to the hydraulic restrictions of bridges and stormwater conduits upstream and downstream of the site.

## 6.0 FLOOD STORAGE EVALUATION

In addition, the updated model was used to conduct a detailed assessment of the impacts of the potential benefit of near-river flood storage projects on three parcels within the study area. The three parcels were identified through coordination with City staff. Those parcels are:

1. 13 Wallis Street.
2. 24 Caller Street;
3. 166R Main Street; and

The property at 24 Caller Street was recently purchased by the City, and the City has held preliminary conversations with the owners of the other two parcels about purchasing those properties. Conceptual level flood storage projects were developed for each of the three parcels, which effectively consists of relocating the walking path further inland, as grades and other site considerations reasonably allow, and creating additional flood storage between the relocated walking path and the sheet pile wall already proposed as part of the 25% Design of the preferred wall alternative.

Weston & Sampson developed four alternative model geometries, one to represent each of the projects and a fourth to represent the construction of all three flood storage projects together. The model was then used to evaluate changes in peak flood elevations within the 1,600-foot-long project site as well as in upstream and downstream areas with the 25% Design of the preferred wall alternative.

Simulations of additional flood storage on the parcel at 166R Main Street indicate only modest benefits to flooding. Reductions in peak flood elevations are generally up to 0.1 feet and localized around Caller Street, as that area is just upstream of the proposed additional flood storage. Flood elevation reductions are greatest for smaller storms, such as the 10-year event, shrinking to roughly 0.05 feet during larger events like the 50- and 100-year storm events. The benefit was also reduced to around 0.05 feet under the 2070 climate scenario as design floods and tides are larger compared to baseline conditions and rising sea levels begin to influence the North River Canal in the Caller Street area, reducing the benefit of additional flood storage at 166R Main Street.

Simulations of additional flood storage on the parcel at 24 Caller Street indicate flood level reductions of 0.1 to 0.3 feet in the area between Wallis Street and Paleologos Street, which does not cross the North River but rather terminates in the left floodplain. Flood reductions are somewhat larger for the smaller recurrence interval events than for the larger, rarer storms – generally 0.2 to 0.3 feet for the 10 and 25-year events and 0.1 to 0.2 feet for the 50- and 100-year events. Simulations of the 2070 climate scenario events do indicate a slight reduction in the benefit of additional flood storage at this site later in the 21<sup>st</sup> century, but flood reductions are still generally expected to be 0.1 to 0.25 for the 10- and 25-year events and 0.05 to 0.15 feet for the 50- and 100-year events.

Simulations of additional flood storage at the third and final parcel, 13 Wallis Street, suggest that localized flood reductions could be achieved in the Memorial Park area and around the railroad embankment immediately downstream of Wallis Street. Flood reductions range from generally from 0.1 to 0.2 feet for a wide range of design floods under both baseline and 2070 climate scenarios.

Finally, Weston & Sampson evaluated the potential benefit on flooding if additional flood storage were incorporated into the wall design at all three parcels. Those combined benefits are presented in Tables

5A and 5B, compared to the 25% Design of the preferred wall alternative, under baseline and 2070 climate scenarios, respectively.

**Table 5A: Reduction in Flood Elevations due to Additional Flood Storage under a Baseline Climate**

Location	100-yr	50-yr	25-yr	10-yr	10-yr with Storm Surge
Goldthwaite at Main	0.0	0.0	0.0	0.0	0.0
Goldthwaite at Church	0.0	0.0	0.0	0.0	0.0
Proctor at Fire Station	0.0	0.0	0.0	0.0	0.0
North River downstream of Wallis	0.4	0.4	0.5	0.6	0.6
North River at Memorial Park	0.3	0.4	0.5	0.6	0.6
North River at Paleologos	0.1	0.1	0.2	0.3	0.3
North River upstream of Caller	0.1	0.0	0.1	0.1	0.1
North River downstream of Caller	0.1	0.1	0.1	0.1	0.1
North River upstream of RR	0.0	0.0	0.0	0.1	0.0
North River downstream of RR	0.0	0.0	0.0	0.0	0.0
North River upstream of Howley	0.0	0.0	0.0	0.1	0.0
North River downstream of Howley	0.0	0.0	0.1	0.0	0.0
North River upstream of Grove	0.0	0.0	0.0	-0.1	0.0
North River upstream of Flint	0.0	0.0	0.0	-0.1	0.0

**Table 5B: Reduction in Flood Elevations due to Additional Flood Storage under a 2070 Climate Scenario**

Location	100-yr	50-yr	25-yr	10-yr	10-yr with Storm Surge
Goldthwaite at Main	0.0	0.0	0.0	0.0	0.0
Goldthwaite at Church	0.0	0.0	0.0	0.0	0.0
Proctor at Fire Station	0.0	0.0	0.0	0.0	0.0
North River downstream of Wallis	0.1	0.4	0.4	0.5	0.4
North River at Memorial Park	0.1	0.3	0.4	0.5	0.4
North River at Paleologos	0.1	0.1	0.1	0.2	0.1
North River upstream of Caller	0.1	0.1	0.1	0.1	0.1
North River downstream of Caller	0.1	0.1	0.1	0.1	0.1
North River upstream of RR	0.0	0.0	0.0	0.0	0.0
North River downstream of RR	0.0	0.0	0.0	0.0	0.0
North River upstream of Howley	0.0	0.0	0.0	0.1	0.0
North River downstream of Howley	0.0	0.0	0.0	0.1	0.0
North River upstream of Grove	0.0	0.0	0.0	0.0	0.0
North River upstream of Flint	0.0	0.0	0.0	0.0	0.0

As shown in Table 5A, creating additional flood storage at all three parcels, would reduce flood elevations between Wallis Street and the area just downstream of Caller Street by 0.1 to 0.6 feet under a baseline climate. Benefits are greatest in the Wallis Street and Memorial Park area, generally 0.3 to 0.6 feet, tapering off to 0.1 to 0.3 feet downstream in the area near Paleologos Street. No significant changes



are expected to flood elevations upstream in the Peabody Square area or downstream in Salem as a result of the additional flood storage.

Under the 2070 climate scenario, flood reductions are generally smaller and further localized near the upstream end of the project area. In the Wallis Street and Memorial Park area, flood elevations are expected to be 0.1 to 0.5 feet lower with the creation of additional flood storage at all three parcels along with the 25% Design of the preferred wall alternative. Those reductions begin to taper off further upstream than their baseline climate counterparts due to the tidal influence extending further into the project area. Flood level reductions are only expected to be on the order of 0.1 to 0.2 feet in the Paleologos Street area.

Based on the model results discussed in this section, creating additional flood storage at 13 Wallis Street and 24 Caller Street could provide modest reductions in peak flood elevations under a wide range of design storms and under both baseline and 2070 climate scenarios. Benefits will be localized to the reach of the North River Canal from Wallis Street to Caller Street. No significant change is expected upstream near Peabody Square or downstream in Salem. In contrast, benefits of additional flood storage at 166R Main Street are minimal.

## 7.0 75% WALL DESIGN EVALUATION

As the project progressed, Weston & Sampson developed an alternative model geometry to represent the 75% Design of the preferred wall alternative, which included modest additional flood storage on the 24 Caller Street parcel. The model was used to evaluate changes in flooding within the 1,600-foot-long project site as well as upstream near Peabody Square and downstream in Salem. The impacts of the 75% wall design on peak flood elevations at key locations along the project site, upstream near Peabody Square and downstream in Salem under baseline climate and 2070 climate scenarios are presented below in Tables 6A and 6B, respectively.

**Table 6A: Reduction in Peak Flood Elevations due to 75% Wall Design under a Baseline Climate**

Location	100-yr	50-yr	25-yr	10-yr	10-yr with Storm Surge
Goldthwaite at Main	0.0	0.0	0.0	0.0	0.0
Goldthwaite at Church	0.0	0.0	0.0	0.0	0.0
Proctor at Fire Station	0.0	0.0	0.0	0.0	0.0
North River downstream of Wallis	0.1	0.1	0.1	0.2	0.2
North River at Memorial Park	0.1	0.1	0.1	0.2	0.2
North River at Paleologos	0.4	0.5	0.5	0.7	0.7
North River upstream of Caller	0.3	0.2	0.3	0.5	0.5
North River downstream of Caller	0.4	0.4	0.4	0.6	0.5
North River upstream of RR	0.0	0.0	0.0	0.0	0.1
North River downstream of RR	0.0	0.0	0.0	0.1	0.0
North River upstream of Howley	0.0	0.0	0.0	0.1	0.0
North River downstream of Howley	0.0	0.0	0.0	0.1	0.0
North River upstream of Grove	0.0	0.0	0.1	0.0	0.0
North River upstream of Flint	0.0	0.0	0.0	0.0	0.0

**Table 6B: Reduction in Peak Flood Elevations due to 75% Wall Design under a 2070 Climate Scenario**

Location	100-yr	50-yr	25-yr	10-yr	10-yr with Storm Surge
Goldthwaite at Main	0.0	0.0	0.0	0.0	0.0
Goldthwaite at Church	0.0	0.0	0.0	0.0	0.0
Proctor at Fire Station	0.0	0.0	0.0	0.0	0.0
North River downstream of Wallis	0.2	0.1	0.1	0.1	0.1
North River at Memorial Park	0.2	0.1	0.1	0.1	0.1
North River at Paleologos	0.4	0.4	0.4	0.5	0.3
North River upstream of Caller	0.2	0.2	0.2	0.2	0.1
North River downstream of Caller	0.2	0.3	0.3	0.4	0.2
North River upstream of RR	0.0	0.0	0.0	0.0	0.0
North River downstream of RR	0.0	0.0	0.0	0.0	0.0
North River upstream of Howley	0.0	0.0	0.0	0.1	0.0
North River downstream of Howley	0.0	0.0	0.0	0.1	0.0
North River upstream of Grove	0.0	0.0	0.0	0.0	0.0
North River upstream of Flint	0.0	0.0	0.0	0.0	0.0

The 75% wall design would increase the hydraulic capacity of the North River Canal from Wallis Street to Caller Street and from Caller Street to the railroad crossing just upstream of Howley Street. As shown in Tables 6A and 6B, these improvements result in modest reductions of peak flood elevations from Wallis Street down to just downstream of Caller Street. The reduction ranges from 0.1 to 0.7 feet under a baseline climate, depending on the precise location and the design event, with smaller storms, such as the 10- and 25-year events experiencing slightly greater benefits. Flood reductions are limited to 0.1 feet under the 10- and 25-year events for areas downstream of the railroad crossing and upstream of Grove Street. Flood reductions do not reach as far downstream as Flint Street as that area is primarily controlled by tidal influences extending upstream from Salem Harbor.

A similar pattern emerges under the 2070 climate scenario with reductions in peak flood elevations generally ranging from 0.1 to 0.5 feet in the area between Wallis and Caller Streets during each of the events.

In both baseline and 2070 climate scenarios, model results indicate that the benefits of the wall design do not extend up into Peabody Square, nor are conditions worsened downstream on the North River in Salem. The benefits of widening the North River Canal are likely localized due to the hydraulic restrictions of bridges and stormwater conduits upstream and downstream of the site.

To depict the potential benefit of the 75% wall design in terms of flooding extents, Weston & Sampson has developed maps of likely flood areas for both baseline and 2070 climate scenarios. See Figures 5 and 6, respectively.



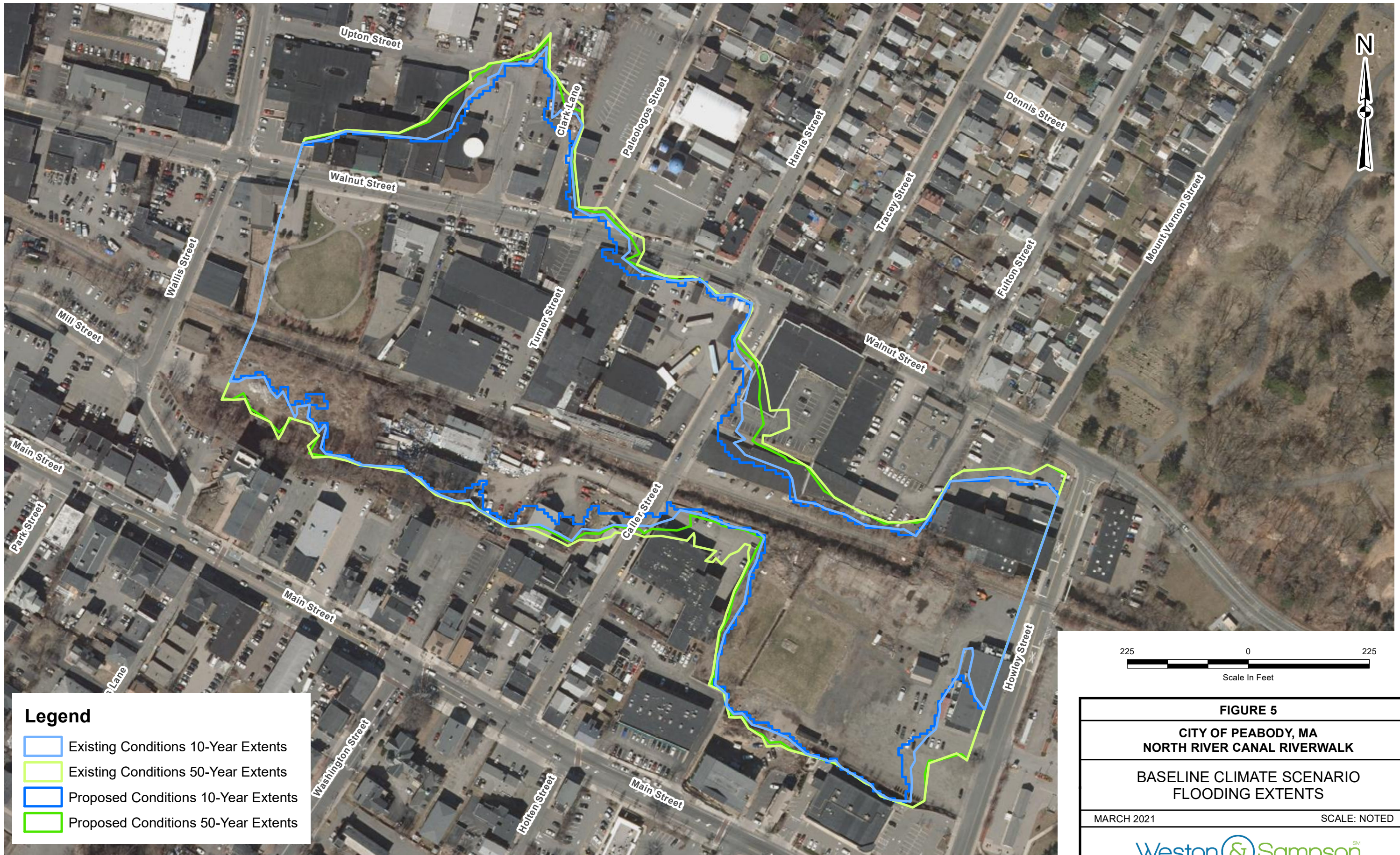



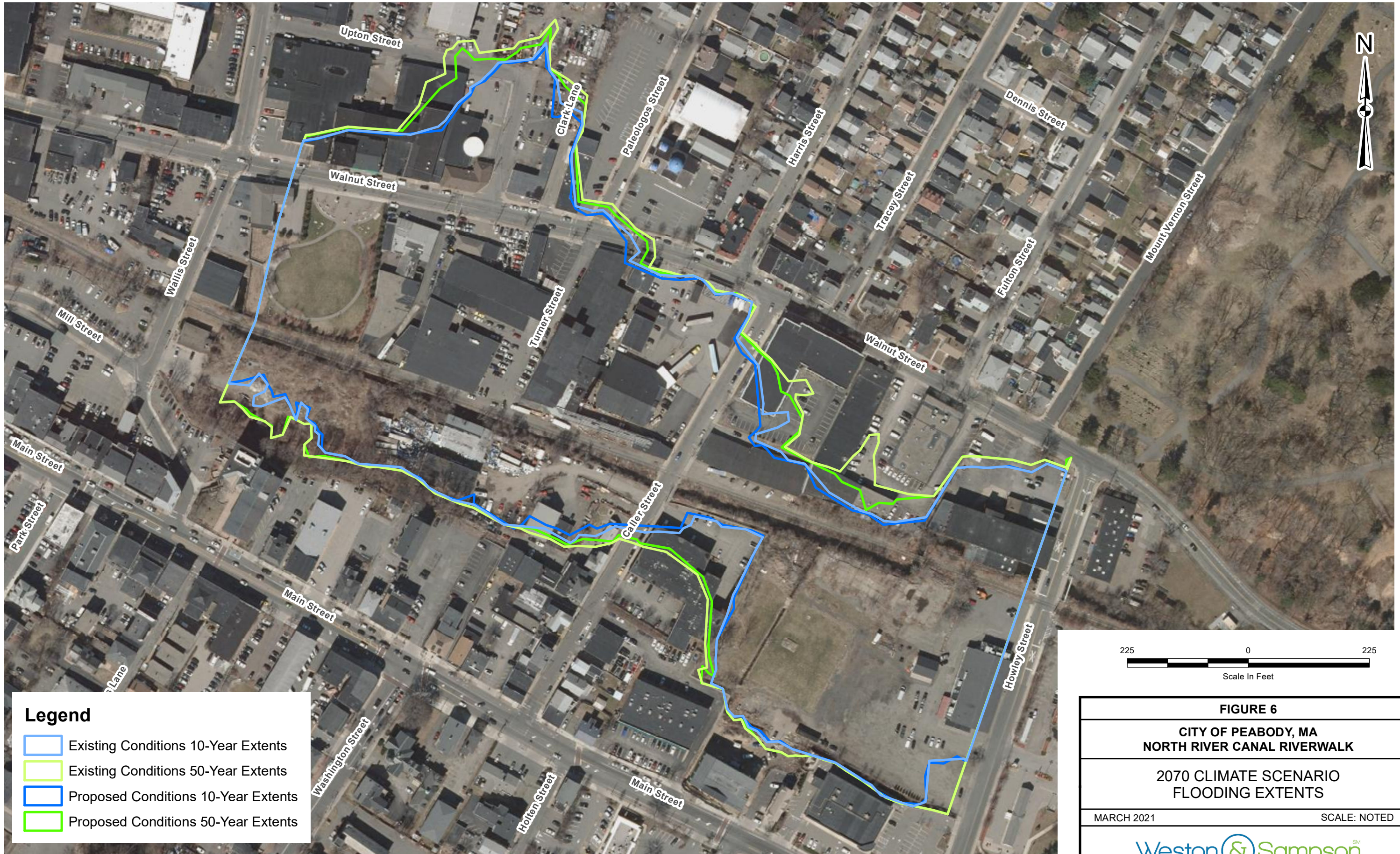

**Legend**

- Existing Conditions 10-Year Extents
- Existing Conditions 50-Year Extents
- Proposed Conditions 10-Year Extents
- Proposed Conditions 50-Year Extents

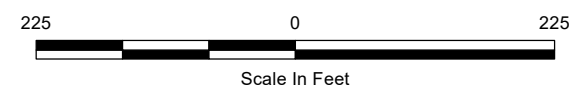

<b>FIGURE 6</b>	
<b>CITY OF PEABODY, MA</b>	
<b>NORTH RIVER CANAL RIVERWALK</b>	
<b>2070 CLIMATE SCENARIO</b>	
<b>FLOODING EXTENTS</b>	
MARCH 2021	SCALE: NOTED



## 8.0 CONCLUSION

Weston & Sampson conducted a Resilience Evaluation during the Preliminary Design Phase of the Peabody North River Canal Resilient Wall, Riverwalk, and Park Project. The preliminary analyses contributed to the selection of a preferred wall alternative. However, those analyses focused solely on general flooding patterns within the study area from Wallis Street to Howley Street in the City and did not include a detailed assessment of either the drainage area (both upstream and downstream) or of the hydraulics of the North River Canal.

More detailed hydrologic and hydraulic (H&H) analyses were conducted during this current phase of the North River Canal project. The City's existing H&H model was updated in several ways, including a review of recent stormwater detention/retention projects in the North River watershed, a windshield survey and spot-check of the size of key culverts and pond outlets, a more detailed representation of the Canal and its floodplain based on a May 2020 survey that included both topographic and bathymetric elements, and finally the inclusion of updated design rainfall events based on the best available design rainfall and tidal data for both baseline and 2070 climate conditions. After these updates, the model was recalibrated against historical observations from the March 2010 flood event to ensure its continued accuracy and usefulness in evaluating changes to the North River Canal.

The updated model was then used to evaluate the potential reductions in peak flood elevations considering the proposed 25% Design of the preferred wall alternative. Model results suggest that the proposed wall design could result in peak flood elevation reductions of 0.4 to 1.2 feet in the area between Wallis Street and just downstream of Caller Street during 10- to 100-year storm events under a baseline climate. Benefits are not expected to extend as far downstream as Howley Street as the hydraulics in that area are controlled by the tidal influence of Salem Harbor. Peak flood elevation reductions between Wallis Street and Caller Street are expected to be somewhat reduced by 2070, generally ranging from 0.3 to 0.7 feet. Model results also indicate that the proposed wall design is not expected to result in significant flood elevation changes either upstream in Peabody Square or downstream in Salem.

The updated model was also used to evaluate the potential benefits of creating additional flood storage in three specific parcels near the study area. Based on the model results discussed in this section, creating additional flood storage at 13 Wallis Street and 24 Caller Street could provide modest reductions in peak flood elevations under a wide range of design storms and under both baseline and 2070 climate scenarios, generally 0.1 to 0.5 feet. Benefits would likely be localized to the reach of the North River Canal from Wallis Street to just downstream of Caller Street. No significant change is expected upstream near Peabody Square or downstream in Salem.



## 9.0 REFERENCES

Metcalf & Eddy and AECOM. April 2008. "Preliminary Design of Flood Mitigation Facilities for Peabody Square Area."

\\wse03.local\WSE\Projects\MA\Peabody MA\MVP Action Grant 2019\Task 6 - Resilience\Report\North River Phase II Resilience Evaluation Report Revised.docx

## APPENDIX K

### Project Management – Monthly Progress Reports

## M E M O R A N D U M

**TO:** Brendan Callahan, Assistant Director of Planning – City of Peabody Massachusetts  
Michelle Rowden - Executive Office of Energy & Environmental Affairs (MassEEA)

**FROM:** Sarah DeStefano, Team Leader – Weston & Sampson

**DATE:** 2/29/20

**SUBJECT:** Monthly Progress Report  
Reporting Period of February 1, 2020 – February 29, 2020  
Report Number No. 1  
FY20-21 MVP Action Grant - Peabody North River Canal Resilient Wall and Riverwalk  
and Park – Phase II

---

Weston & Sampson is pleased to provide this summary of the status of engineering and design services related to the execution of the City of Peabody's FY20-FY21 North River Canal Resilient Wall and Riverwalk Grant Project, which is funded by the Massachusetts Executive Office of Energy & Environmental Affairs (MassEEA) through its Municipal Vulnerability Preparedness (MVP) Action Grant Program.

- Weston & Sampson's Team participated in a Kick-Off Meeting on Friday, February 28, 2020 with the City of Peabody and MassEEA to discuss the project. Agenda items included the following:
  - Welcome & Introductions
    - Project Team & Lines of Communication
  - Project Overview - City of Peabody
  - Scope of Work – Weston & Sampson
    - Types of Activities that will occur on privately owned properties.
    - Access Agreements & Coordination with private property owners
    - Schedule
  - Next Steps
  - Miscellaneous / Questions & Answers
- A copy of the meeting sign-in sheet, revised project schedule, deliverable, and budget breakdown and 25% design documents are attached.
- A summary of the information discussed during the Kick-Off meeting is provided below:
  - Welcome & Introductions
    - Project Team
      - City of Peabody – Brendan Callahan (Project Manager) and Will Paulitz (City Engineer)
      - Weston & Sampson Project Team Leaders



- Project Manager – Sarah DeStefano
  - Resiliency – Andy Walker
  - Structural – Scott Bruso
  - Geotech – Stephanie Bridges
  - Environmental – George Naslas, LSP
  - Permitting – Tony Zerilli
  - Landscape Architects – Jeanne Lukenda
  - Survey – Mike Wilmes
- Lines of Communication
    - In general, communication will be directed through Brendan and Sarah as Project Managers. Monthly progress calls will be scheduled with all team leaders and the City so that they can participate when their respective tasks and deliverables need to be discussed. In addition, monthly progress reports will be generated at the completion of each month, with input from each respective discipline as needed. Similar to the last grant, the City is suggesting that progress reports be submitted to EEA within 15 days of close of the month.
- Project Overview:
    - The City of Peabody is eager to increase its resilience against flooding in Peabody Square and move forward with Phase II of the comprehensive project along the North River Canal that will improve resiliency, address site contamination from historic use as a tannery district, and create a park resource that enhances public access and vitality of the area.
    - In 2018, the City of Peabody received a \$224,215.98 MVP Grant to complete Phase I of the Project, which included a resiliency evaluation to determine how best to accommodate flood waters along the banks of the canal; a preliminary redesign of the wall on the south bank; a preliminary design of a Riverwalk along the south bank; and development of a permitting strategy to support the project.
    - This grant is intended to continue this project through Phase II, which would include progressing the project through the 75% design phase and submitting permitting applications for approvals through various State and Federal Agencies.
    - The City provided a summary of general stormwater / watershed projects that have been completed by the City to date to help alleviate flooding in Peabody center. EEA noted that there is lots of potential for studying this problem as a potential future project with EEA.
    - The City of Peabody explained that they took title to the 24 Caller Street property in the summer of 2019 and are looking to purchase the portion of the 21 Caller Street property required for the purposes of the Riverwalk project. The City anticipates acquiring four (4) permanent easements at the remaining properties (13 Wallis St, 18 & 20 Howley Street and 166R Main Street).
    - The City noted that several of the property owners had not been as cooperative when discussing the feasibility of the City purchasing their properties given the current existing

limited development options as well as zoning, flooding and contamination concerns at the properties. However, the City acknowledged that conversations with the former owner of the 24 Caller Street property took several years before they were successful in negotiating a purchase and sales agreement that was amenable to both parties.

- The City will continue to engage property owners in discussions regarding property acquisition and/or easements. The City understands that permanent easements cannot be finalized until designs plans for Riverwalk are completed.
- Scope of Work
  - Weston & Sampson provided a brief summary of the activities that will be completed as part of the MVP grant including:
    - Resiliency Evaluation
      - H&H Study – this will be conducted at the beginning stages of the FY20 project in order to influence the final design of the wall and Riverwalk.
    - South Wall 75% Design
      - Geotechnical subsurface investigation and summary report
      - Survey and Base Map / Plans
      - Drawings and Specifications / Quantity Takeoffs and Cost Estimate
      - Draft and Final 75% Design Plans
      - Task commences in FY20 but is completed in FY21.
    - Riverwalk Design
      - Draft and Final 75% Design
      - Stormwater Considerations
        - 4-feet of vegetation on each side of the path will provide stormwater management
        - The use of green infrastructure is a crucial component to the project. The Riverwalk will optimize and maximize green infrastructure, resiliency, and flood storage as part of the 75% design.
        - The City has installed and maintained numerous green infrastructure and Low Impact Development (LID) design elements at several projects throughout the City.
        - Vegetated pathway edges and raingarden opportunities within the project area will provide pragmatic stormwater and flood storage management. All Riverwalk areas will be designed and constructed to accommodate flooding.
        - The project involves the creation of an open space area at 24 Caller Street and the opportunity for additional stormwater management.
      - Heat Island Effects
        - Low maintenance groundcover and tree plantings will supplement the existing vegetation, provide shade, and reduce heat island effect.
  - Permitting
    - Draft and Final Permitting Submittals

- EEA noted that MassDEP wants to be kept abreast of the project and requested a pre-application meeting with all entities that will be reviewing the project prior to the submission of any formal permit applications.
- The City and Weston & Sampson explained that they had a pre-application meeting with several divisions of MassDEP during Phase I of project to get their feedback regarding the proposed wall repair alternative and proposed Riverwalk project. Conceptually, MassDEP fully supported preferred alternative and stated that they were looking forward to working with the City on this next phase of the project.
- MCP Strategy
  - MCP Soil Management Strategy & Cost Estimates
  - Haz Mat Assessment of Foundations at 166R Main Street property
- Community Engagement
  - Two (2) Public Meetings – one earlier in the draft design process that takes into consideration the feedback received at the first public meeting conducted during Phase I of the project and the other after the completion of the 75% design.
- Program Management
  - Monthly progress meetings and reports (see lines of communication above)
  - EEA confirmed that all work for FY20 needs to be completed by 6/30/20 and that funds cannot be moved from one fiscal year to the other.
  - All activities and Final Report to be completed by 6/30/21.
  - Project will be set up as a Lump Sum, percent complete with subtasks and deliverables, as appropriate, to accommodate grant reimbursement and payment.
    - EEA noted that Project Management activities (Task 7) cannot be reimbursed until 100% completed at the end of each fiscal year and that note every task has a tangible deliverable.
  - Access Agreements and Coordination with Property Owners
    - Weston & Sampson will work with the City to execute new access agreements for the next round of subsurface investigation (geotechnical / structural) and survey activities that will need to be conducted at the properties.
    - Weston & Sampson will generate a proposed subsurface investigation location plan that the City can utilize when meeting with the private property owners to discuss the proposed activities.
- Next Steps:
  - The City will provide EEA with an updated schedule of deliverables and cost break down for their review / approval. Additional deliverables were provided in the schedule to accommodate grant reimbursement for task/activities that span large time frames as part of the project. Fiscal Year totals did not change. The City will determine if their grant match can be paid on a percent complete basis before final deliverables are produced.



- Access agreements will be negotiated and executed with each of the applicable private property owners for the project, including 21 Caller Street, 18 & 20 Howley Street, 13 Wallis Street and 166R Main Street.
- Certificates of Insurance (COI) will also be provided for each of the private property owners referenced above. Each individual property owner and the City of Peabody will be included as additional insured with respect to Weston & Sampson's General, Auto, and Umbrella Liability policies.
- Weston & Sampson will provide the City with a proposed subsurface investigation location plan so the City can coordinate with the private property owners.

#### **TASK 7. PROGRAM MANAGEMENT**

- Weston & Sampson has been working with the City of Peabody to formalize a contract for FY20-FY21 MVP Action Grant activities. The contract is expected to be executed and signed by both parties in early March 2020.
- Internal Weston & Sampson project coordination / kick-off was held the week of February 24, 2020. Agenda items included: project overview; anticipated task schedule and deliverables; budget and deadlines; action items; and setting a day/time for regular monthly status meetings, etc.
- No other Task Specific Activities (Tasks 1 – 6) were conducted this month.

#### **SCOPE & BUDGET**

- There were no changes to the scope or proposed project budget this month. No additional assistance from EEA is requested at this time.
- A copy of the budget draw down / tracking table will be provided in future monthly progress reports as subtasks / tasks are completed and milestone deliverables are achieved.

## M E M O R A N D U M

**TO:** Brendan Callahan, Assistant Director of Planning – City of Peabody Massachusetts  
Michelle Rowden - Executive Office of Energy & Environmental Affairs (MassEEA)

**FROM:** Sarah DeStefano, Team Leader – Weston & Sampson

**DATE:** 3/31/20

**SUBJECT:** Monthly Progress Report  
Reporting Period of March 1, 2020 – March 31, 2020  
Report Number No. 2  
FY20-21 MVP Action Grant - Peabody North River Canal Resilient Wall and Riverwalk  
and Park – Phase II

---

Weston & Sampson is pleased to provide this summary of the status of engineering and design services related to the execution of the City of Peabody's FY20-FY21 North River Canal Resilient Wall and Riverwalk Grant Project (the Site), which is funded by the Massachusetts Executive Office of Energy & Environmental Affairs (MassEEA) through its Municipal Vulnerability Preparedness (MVP) Action Grant Program.

**TASK 1. SOUTH WALL STRUCTURAL DESIGN****1.1 Geotechnical**

- Weston & Sampson provided the City with a proposed subsurface investigation location plan (see attached figure). The plan shows existing borings and test pits as well as the proposed additional borings (shown in red cloud) so the City could coordinate accordingly with the private property owners of 13 Wallis and 18 Howley Street for the following proposed geotechnical investigation activities:
  - 13 Wallis Street: Weston & Sampson will arrange for a qualified boring subcontractor to advance two (2) test borings at approximate locations shown on the attached figure. Borings will be approximately 5 inches in diameter and will be advanced to a depth of about 25 feet using a track-mounted drilling rig. Borings will be backfilled with soil cuttings upon completion. Weston & Sampson will make recommendations for allowable soil bearing capacity, lateral earth pressures, frictional resistance, and seismic design considerations based on the findings from the exploration program.
  - 18 Howley Street: Weston & Sampson will arrange for a qualified boring subcontractor to conduct one (1) test boring to depths of about 25 feet at approximate locations shown on the attached figure. The boring will be approximately 5 inches in diameter and will

advanced to a depth of about 25 feet using a track-mounted drilling rig. The boring will be backfilled with soil cuttings upon completion. Weston & Sampson will make recommendations for allowable soil bearing capacity, lateral earth pressures, frictional resistance, and seismic design considerations based on the findings from the exploration program.

- After receiving permission from the private property owners, Weston & Sampson and the City met on Site with the driller on Wednesday, March 18, 2020 to go over the logistics and accessibility of the proposed subsurface investigation activities.
- It was determined that the drill rig is not able to access the proposed boring location at the Strongwater Brook upstream crossing location at 18 Howley Street. This proposed boring location has therefore been eliminated from the proposed geotechnical activities. Design criteria will be provided based on nearby borings that we performed on the opposite side of the brook during the previous MVP grant.
- The drilling subcontractor is tentatively scheduled to drill the proposed borings at 13 Wallis Street on Monday April 13, 2020. The City will be utilizing DPW staff to clear a path to the proposed locations prior to that date.

### **1.2 Geotechnical Survey**

- Weston & Sampson coordinated with internal team members to finalize multidiscipline survey needs prior to the initiation of field related activities.

### **1.3 Structural Analysis and Calculations**

- Weston & Sampson's Structural Team commenced boardwalk and sheet pile coordination and schematic framing layout activities for the project. These activities including determining the required sheet pile layout and looking into design parameters that would be needed for analysis, as well as drafting concepts for the structural boardwalk framing (i.e. how the boardwalk would be supported).

## **TASK 7. PROGRAM MANAGEMENT**

- Weston & Sampson worked with the City of Peabody to formalize a contract for FY20-FY21 MVP Action Grant activities. The contract was executed and signed by both parties on approximately March 17, 2020.
- Access agreements are in the process of being negotiated and executed with each of the applicable private property owners for the project, including 21 Caller Street, 18 & 20 Howley Street, 13 Wallis Street and 166R Main Street. Upon successful execution of the access agreements, Certificates of Insurance (COI) will also be provided for each of the private property owners referenced above. Each individual property owner and the City of Peabody will be



included as additional insured with respect to Weston & Sampson's General, Auto, and Umbrella Liability policies.

- Once Access Agreements are formally executed, field related activities including geotechnical subsurface investigations and survey work may commence.
- At this time, it is unclear if and/or how the current COVID-19 Pandemic will impact the proposed project and/or schedule.

No other Task Specific Activities (Tasks 2 – 6) were conducted this month.

#### **SCOPE & BUDGET**

- There were no changes to the scope or proposed project budget this month. No additional assistance from EEA is requested at this time.
- A copy of the budget draw down / tracking table will be provided in future monthly progress reports as subtasks / tasks are completed and milestone deliverables are achieved.

# MEMORANDUM

**TO:** Brendan Callahan, Assistant Director of Planning – City of Peabody Massachusetts  
Michelle Rowden - Executive Office of Energy & Environmental Affairs (MassEEA)

**FROM:** Sarah DeStefano, Team Leader – Weston & Sampson

**DATE:** 4/29/20

**SUBJECT:** Monthly Progress Report  
Reporting Period of April 1, 2020 – April 30, 2020  
Report Number No. 3  
FY20-21 MVP Action Grant - Peabody North River Canal Resilient Wall and Riverwalk  
and Park – Phase II

---

Weston & Sampson is pleased to provide this summary of the status of engineering and design services related to the execution of the City of Peabody's FY20-FY21 North River Canal Resilient Wall and Riverwalk Grant Project (the Site), which is funded by the Massachusetts Executive Office of Energy & Environmental Affairs (MassEEA) through its Municipal Vulnerability Preparedness (MVP) Action Grant Program.

## **TASK 1. SOUTH WALL STRUCTURAL DESIGN**

### **1.1 Geotechnical**

- Weston & Sampson arranged for a qualified boring subcontractor, New England Boring Contractors of Derry, New Hampshire, to advance two (2) test borings (B-101 and B-102) at 13 Wallis Street on April 13, 2020. Borings are approximately 5 inches in diameter and were advanced to a depths ranging from about 30 to 40 feet below ground surface (bgs) using a track-mounted drilling rig. Borings were backfilled with soil cuttings upon completion.
- The soil samples from the borings have been reviewed by Weston & Sampson staff, and selected samples have been submitted to the Geotesting Express laboratory in Acton, Massachusetts for testing. Turnaround times are a bit slower than usual, due to the current COVID-19 pandemic, and testing results are expected in about 2 weeks.
- Weston & Sampson will make recommendations for allowable soil bearing capacity, lateral earth pressures, frictional resistance, and seismic design considerations based on the findings from the exploration program.

## 1.2 Geotechnical Survey

- Weston & Sampson coordinated with the City to initiate field related survey activities. These activities have been delayed due to the current COVID-19 Pandemic.
  - Access agreements have been executed with 3 of the 4 private property owners identified along the proposed Riverwalk project area. The survey activity requires access from all of the private property owners along the proposed Riverwalk project area. Survey notices were also sent to private property owners in the general project area that may need to be accessed to complete survey related activities.
  - Access is still pending for the 21 Caller Street property, which is critical to the success of the project. The preferred wall alternative, Alternative C - Sheet Pile Wall Option 2 with Sloped Bank, may not be feasible along the entire length of the proposed Riverwalk due to existing structures and grade, design constraints and/or pinch points, such as the parking lot at 21 Caller Street, and may require a limited length of one of the other wall alternatives to be considered. As an example, the Sheet Pile Wall Option 1 could be used for a short distance along the bank until a larger portion of land is available behind the wall to return to the Sheet Pile Wall Option 2. The feasibility in areas such as 21 Caller Street is required to be further evaluated during this phase of the design. However, this design work is dependent upon the results of the survey activities.
  - The delay in the execution of the access agreement to 21 Caller Street, which has taken longer than anticipated due to the current COVID-19 situation, is impacting/delaying the schedule and completion of the survey work which will in turn delay the Base Plan deliverable (due 5/15/20) and may also impact the Structural and Resiliency Deliverables (6/15/20) if access is delayed beyond the first weeks of May.
  - In order to keep the project moving, survey activities are scheduled to commence the week of May 4, 2020, although it is much more efficient and effective from a technical and cost perspective for all of the survey work to be completed at one time. Separating the survey work into phases will further delay the schedule and timeline for project deliverables, and increase costs. The City is hopeful access will be gained in time to complete the survey at one time.
  - Specifically, access to the 21 Caller Street project has been complicated by the presence of a homeless encampment in the area which is having a significant impact on the property owner's tenants and business operations, etc. The property owner would like the City to move this vulnerable group from the area, however based upon the current pandemic, the CDC is recommending the City allow homeless encampments to remain in place for now and the City's homeless task force supports this approach. It is the City's priority to support the homeless in their community.



- The City is working with a local coalition to find alternative housing for this vulnerable group. However, City Hall has been very busy responding to the pandemic and with other COVID-19 related matters, such as small business loans, etc. and has not been able to provide resources needed to expedite this issue and support access needs as part of the MVP project. Although the City needs more time, the City is confident that access to the 21 Caller Street property will eventually be granted as they have worked harmoniously with this property owner in the past on this project and he has granted access on several occasions.

### **1.3 Structural Analysis and Calculations**

- Weston & Sampson's Structural Team continued boardwalk and sheet pile coordination and schematic framing layout activities for the project. These activities including:
  - Meeting with the Landscape Architects to understand their conceptual design for the boardwalk near the 24 Caller Street property
  - Commencing preliminary calculations for boardwalk widths
  - Starting preliminary foundation layout of boardwalk supports
  - Coordinating with Geotechnical Team for assistance with sheet pile design

### **TASK 6. UPDATED RESILIENCY EVALUATION**

- Weston & Sampson conducted an in-house coordination meeting to determine the appropriate planning horizon, recurrent interval, and duration of design storms that we will use in our hydrologic and hydraulic (H&H) model.
- Weston & Sampson developed site specific design rainfall depth estimates for future climate scenarios from downscaled global and regional climate model outputs.
- Weston & Sampson requested and received a copy of the City's most recent (c. 2010-2013) PC-SWMM model (H&H) for the North River watershed, channel, and stormwater conduits. Weston & Sampson have opened the model, reprogrammed various file paths, and successfully several design events.
- Weston & Sampson conducted a coordination call with Will Paulitz and Brendan Callahan from the City to identify projects that increased flood storage within the North River watershed since 2010 so that they can be incorporated into the updated PC-SWMM model. Weston & Sampson will coordinate field efforts next month to visit these sites and confirm their layout and outlet dimensions and conduct a general windshield survey of the watershed, visiting and measuring key hydraulic restrictions to ensure they are accurately reflected in the model.
- Weston & Sampson requested historical flooding observations with which to calibrate the updated PC-SWMM model. The City indicated the existing of a memo summarizing observations made and survey data taken during the March 2010 event. The memo will be reviewed by Weston & Sampson to identify useful calibration data.

## TASK 7. PROGRAM MANAGEMENT

- Monthly progress reports have been submitted to EEA.
- A conference call was conducted with EEA on 4/29/20 to make the EEA aware of the current COVID-19 pandemic related delays in the project schedule and the potential impact on deliverables required by the end of the fiscal year. EEA will be provided with another update by the City in the upcoming weeks in the event a formal extension / amendment is necessary.
- At this time, it is unclear how significantly the current COVID-19 Pandemic will impact the proposed project and/or schedule of deliverables, beyond what was highlighted in the sections above. The City expects to have a better handle on this situation in the upcoming weeks.

No other Task Specific Activities (Tasks 2 – 5) were conducted this month.

## SCOPE & BUDGET

- We anticipate a delay in the completion of the Survey Base Plan that was originally scheduled to be completed by 05/15/20. There were no other changes to the scope or proposed project budget at this time. No additional assistance from EEA is currently requested.
- A copy of the budget draw down / tracking table will be provided in future monthly progress reports as subtasks / tasks are completed and milestone deliverables are achieved.

## M E M O R A N D U M

**TO:** Brendan Callahan, Assistant Director of Planning – City of Peabody Massachusetts  
Michelle Rowden - Executive Office of Energy & Environmental Affairs (MassEEA)

**FROM:** Sarah DeStefano, Team Leader – Weston & Sampson

**DATE:** 5/29/20

**SUBJECT:** Monthly Progress Report  
Reporting Period of April 30, 2020 – May 29, 2020  
Report Number No. 2  
FY20-21 MVP Action Grant - Peabody North River Canal Resilient Wall and Riverwalk  
and Park – Phase II

---

Weston & Sampson is pleased to provide this summary of the status of engineering and design services related to the execution of the City of Peabody's FY20-FY21 North River Canal Resilient Wall and Riverwalk Grant Project (the Site), which is funded by the Massachusetts Executive Office of Energy & Environmental Affairs (MassEEA) through its Municipal Vulnerability Preparedness (MVP) Action Grant Program.

**TASK 1. SOUTH WALL STRUCTURAL DESIGN****1.1 Geotechnical**

- Following completion of the subsurface explorations and laboratory testing, Weston & Sampson's Geotechnical team updated the Project's preliminary geotechnical analyses and recommendations prepared as part of Preliminary Design and drafted a design-level geotechnical recommendations report. The geotechnical report was finalized on 5/29/20 and included the following, as applicable to the proposed construction:
  - A description of the subsurface exploration program, a site plan showing exploration location, exploration logs, and a discussion of the subsurface conditions encountered.
  - A summary of existing conditions at the Site.
  - A summary of the proposed construction such as proposed excavation depths, fill heights, structural loads, and other structural information provided by the Project design team.
  - A discussion of geotechnical considerations for design and construction of the proposed site development and new structures, including settlement considerations, slope stability considerations, and an assessment of liquefaction potential.
  - Recommendations for design and construction of proposed canal walls including recommended foundation type, allowable bearing capacities, minimum embedment depths, seismic design requirements, sliding coefficients, lateral earth pressures, and estimated settlement, based on the findings from the exploration program.



## 1.2 Geotechnical Survey

- A Topographic Survey was conducted for the MVP project runs along the canal between Wallis Street and Howley Street in Peabody, Massachusetts and also included the entirety of the 24 Caller Street parcel. Weston & Sampson Survey team performed the following services:
  - Topographic Survey
    - Data was collected regarding the location of existing physical features and representative ground elevations
    - Processed field data and performed computations and drafting as necessary to prepare topographic base map of the subject area. The topographic survey was added to the Property Survey previously prepared showing the parcels and proposed easements. The updated base map depicts the following physical features, as applicable:
      - Contours of the ground surface at one (1) foot intervals extending at least to the project limits.
      - Spot elevations will be taken at approximately fifty (50) foot intervals along sidewalks, curbs, gutter lines, edges and centerlines of paved roadways, and edges of driveways within the project area.
      - Existing buildings lying within the project area will be located and depicted.
      - The location of ditches, channels, existing drainage pipes or culverts passing under or through the site, which are visible and accessible at the time of the field survey.
      - The location of utility poles, gate valves, catch basins, manholes, light standards and other evidence of utilities will be shown.
      - Isolated or specimen trees of 6" caliper or larger will be located and identified as to size and general type. No attempt was made to identify the genus or species of individual trees.
      - For walls, the bottom and top, front and back edges and material will be shown.
      - The Limits of the AUL at 20-22 Howley Street will be shown.
      - Benchmarks, established during the field survey, will be located and described on the mapping.
  - Stream Transects
    - Transects across parts of the stream were identified at up to 15 locations. The team surveyed any change in slope with a minimum of about 15 shots per transect, including at least 5 below the water line. In addition, the team surveyed with inverts and roadway elevations of all four crossings (2 railroads, Caller Street, and Howley Street), as well as the ordinary high water (OHW) elevation.
  - Compiled Utility Mapping

- During the performance of field survey activities, Survey Team members attempted to locate surficial evidence of below grade structures and utility lines. Surficial evidence includes manholes, storm drain grates, gate valves, access covers, shutoff valves, vault covers, vent grates and painted marks by others representing the location of underground lines. Weston & Sampson field staff attempted to gather data for storm drains and manholes, which were visible, accessible and could be opened without danger to our staff or the general public. The Survey team gathered such data if it was readily available from the ground surface. Due to health and safety considerations, Weston & Sampson staff did not enter underground structures of any type.
- As a part of our analysis and mapping, the Survey Team depicted the approximate location of below grade structures and utility lines based on the location of evidence and interpretation of record maps and documents. Since these facilities are not visible and since we must rely, in large part, on data obtained from other sources, Weston & Sampson can make no representation as to the completeness or accuracy of the information contained in our mapping regarding below grade features.
- The survey base-map was finalized 5/28/20.

### **1.3 Structural Analysis and Calculations**

- Weston & Sampson's Structural Team continued boardwalk and sheet pile coordination and schematic framing layout activities for the project. These activities including:
  - Reviewing the base survey plan and updating base structural plans accordingly.
  - Coordinating with Geotechnical Team for assistance with sheet pile design constraints
  - Conducting micropile layout for boardwalk and Strongwater Brook bridge foundations.
  - Continued calculations on timber boardwalk framing layout.

## **TASK 6. UPDATED RESILIENCY EVALUATION**

- Weston & Sampson updated the City's PC-SWMM stormwater model to correct broken links. Model is now up and running.
- Weston & Sampson incorporated site-specific design rainfall depth estimates for baseline (NOAA14) and future climate scenarios (downscaled global and regional climate model outputs) into the PC-SWMM model.
- Weston & Sampson worked with sub-contractor (Woods Hole Group) to develop site-specific estimates of future sea level rise.
- Weston & Sampson conducted a field reconnaissance to visit recent stormwater infrastructure sites to confirm their layout and outlet dimensions and conducted a general windshield survey of

the watershed, visiting and measuring key hydraulic restrictions to ensure they are accurately reflected in the model, and updated the PC-SWMM model geometry as necessary.

#### **TASK 7. PROGRAM MANAGEMENT**

- Monthly progress reports have been submitted to EEA.
- Communicated with regarding COVID-19 pandemic related delays in the project schedule and the potential impact on deliverables required by the end of the fiscal year. It was determined that a formal extension / amendment was not necessary as all deliverables could be completed by 6/30/20.

No other Task Specific Activities (Tasks 2 – 5) were conducted this month.

#### **SCOPE & BUDGET**

- As detailed in last month's status report, a delay was anticipated in the completion of the Survey Base Plan that was originally scheduled to be completed by 05/15/20. There were no other changes to the scope or proposed project budget at this time. No additional assistance from EEA is currently requested.
- A copy of the budget draw down / tracking table will be provided in future monthly progress reports as subtasks / tasks are completed and milestone deliverables are achieved.



# MEMORANDUM

**TO:** Brendan Callahan, Assistant Director of Planning – City of Peabody Massachusetts  
Michelle Rowden - Executive Office of Energy & Environmental Affairs (MassEEA)

**FROM:** Sarah DeStefano, Team Leader – Weston & Sampson

**DATE:** 6/30/20

**SUBJECT:** Monthly Progress Report  
Reporting Period of May 30, 2020 – June 30, 2020  
Report Number No. 5  
FY20-21 MVP Action Grant - Peabody North River Canal Resilient Wall and Riverwalk  
and Park – Phase II

---

Weston & Sampson is pleased to provide this summary of the status of engineering and design services related to the execution of the City of Peabody's FY20-FY21 North River Canal Resilient Wall and Riverwalk Grant Project (the Site), which is funded by the Massachusetts Executive Office of Energy & Environmental Affairs (MassEEA) through its Municipal Vulnerability Preparedness (MVP) Action Grant Program.

## **TASK 1. SOUTH WALL STRUCTURAL DESIGN**

### **1.1 Geotechnical**

- The geotechnical report was finalized last month on 5/29/20.

### **1.2 Geotechnical Survey**

- The survey base-map was finalized last month on 5/28/20.

### **1.3 Structural Analysis and Calculations**

- As part of the proposed project, the existing south wall of the canal will be demolished within the project limits, and replaced with a new full-height wall, or combination partial-height wall and vegetated or armored slope. The new wall will tie-in to the existing canal walls at the Caller Street bridge. Proposed wall heights range from about 3 to 6 feet, and slope heights range from about 2 to 4 feet. The new wall will consist of driven steel sheet piles along most of the project alignment. Weston & Sampson's Structural Team completed the design calculation package for the proposed North River Canal Wall, including sheet pile, helical pier/pile, boardwalk, and pedestrian timber bridge designs, on 6/15/20.
- The draft 50% designs of the canal wall were submitted with the design calculations on 6/15/20.

## TASK 6. UPDATED RESILIENCY EVALUATION

- Detailed hydrologic and hydraulic (H&H) analyses were conducted during this current phase of the North River Canal project. The City's existing H&H model was updated in several ways, including a review of recent stormwater detention/retention projects in the North River watershed, a windshield survey and spot-check of the size of key culverts and pond outlets, a more detailed representation of the Canal and its floodplain based on a May 2020 survey that included both topographic and bathymetric elements, and finally the inclusion of updated design rainfall events based on the best available design rainfall and tidal data for both baseline and 2070 climate conditions. After these updates, the model was recalibrated against historical observations from the March 2010 flood event to ensure its continued accuracy and usefulness in evaluating changes to the North River Canal.
- The updated model was then used to evaluate the potential reductions in peak flood elevations considering the proposed 25% Design of the preferred wall alternative. Model results suggest that the proposed wall design could result in peak flood elevation reductions of 0.4 to 1.2 feet in the area between Wallis Street and just downstream of Caller Street during the 10- to 100-year events under a baseline climate. Benefits are not expected to extend as far downstream as Howley Street as the hydraulics in that area are controlled by the tidal influence of Salem Harbor. Peak flood elevation reductions between Wallis Street and Caller Street are expected to be somewhat reduced by 2070, generally ranging from 0.3 to 0.8 feet. Model results also indicate that the proposed wall design is not expected to result in significant flood elevation changes either upstream in Peabody Square or downstream in Salem.
- The updated model was also used to evaluate the potential benefits of creating additional flood storage in three (3) specific parcels near the study area. Based on the model results discussed in this section, creating additional flood storage at 13 Wallis Street and 24 Caller Street could provide modest reductions in peak flood elevations under a wide range of design storms and under both baseline and 2070 climate scenarios, generally 0.1 to 0.5 feet. Benefits would likely be localized to the reach of the North River Canal from Wallis Street to Caller Street. No significant change is expected upstream near Peabody Square or downstream in Salem.
- Weston & Sampson H&H report summarizing these updates was completed on 6/16/20.

## TASK 7. PROGRAM MANAGEMENT

- Monthly progress reports have been submitted to EEA.
- Communicated with regards to COVID-19 pandemic related delays in the project schedule and the potential impact on deliverables required by the end of the fiscal year. It was determined that a formal extension / amendment was not necessary as all deliverables could be completed by 6/30/20.

No other Task Specific Activities (Tasks 2 – 5) were conducted this month.

## SCOPE & BUDGET

- As detailed in last month's status report, a delay was anticipated in the completion of the Survey Base Plan that was originally scheduled to be completed by 05/15/20. There are no other changes to the scope or proposed project budget currently. No additional assistance from EEA is presently requested.
- A copy of the budget draw down / tracking table will be provided in future monthly progress reports as subtasks / tasks are completed and milestone deliverables are achieved.
- The City is working to execute a contract amendment with Weston & Sampson to complete FY21 tasks.



# MEMORANDUM

**TO:** Brendan Callahan, Assistant Director of Planning – City of Peabody Massachusetts  
Michelle Rowden - Executive Office of Energy & Environmental Affairs (MassEEA)

**FROM:** Sarah DeStefano, Team Leader – Weston & Sampson

**DATE:** 8/3/20

**SUBJECT:** Monthly Progress Report  
Reporting Period of July 1, 2020 – July 30, 2020  
Report Number No. 6  
FY20-21 MVP Action Grant - Peabody North River Canal Resilient Wall and Riverwalk  
and Park – Phase II

---

Weston & Sampson is pleased to provide this summary of the status of engineering and design services related to the execution of the City of Peabody's FY20-FY21 North River Canal Resilient Wall and Riverwalk Grant Project (the Site), which is funded by the Massachusetts Executive Office of Energy & Environmental Affairs (MassEEA) through its Municipal Vulnerability Preparedness (MVP) Action Grant Program.

## **TASK 1. SOUTH WALL STRUCTURAL DESIGN**

### **1.1 Geotechnical**

- The geotechnical report was finalized in FY20.

### **1.2 Geotechnical Survey**

- The survey base-map was finalized in FY20.

### **1.3 Structural Analysis and Calculations**

- Weston & Sampson's Structural Team completed the design calculation package for the proposed North River Canal Wall, including sheet pile, helical pier/pile, boardwalk, and pedestrian timber bridge designs in FY20.

### **1.3 Drawings and Technical Specifications**

- The Structural team continues to advance the draft designs of the canal wall and is coordinating with the Landscape Architectural Team regarding the design of the boardwalk and pedestrian bridge proposed over Strongwater Brook

### **1.5 Quantity Takeoffs and Cost Estimation**

- No activities were conducted this month.

## **TASK 2: RIVERWALK 75% DESIGN**

### **2.1 Draft Final Design**

- Coordinated with Structural Engineering Team regarding the design of the boardwalk and pedestrian bridge proposed over Strongwater Brook.
- Weston & Sampson' Landscape Architectural Team commenced further evaluation and refinement of the best location and design for the Riverwalk and identification of adjacent public open space opportunities.

### **2.2 Final Design**

- No activities were conducted this month.

## **Task 3: Environmental Permitting**

### **3.1 Draft Permit Submittals**

- No activities were conducted this month.

### **3.2 Finalize Permit Submittals**

- No activities were conducted this month.

## **Task 4: MPC Strategy for Soil Management and Cost Estimation**

### **4.1 MPC Strategy for Soil Management and Cost Estimation**

- No activities were conducted this month.

### **4.2 Hazmat Assessment of Foundations**

- Weston & Sampson commenced coordination activities to conduct the hazardous materials assessment of foundations scheduled for demolition located within the Project limit on the 166R Main Street parcel.

## **Task 5: Community Engagement**

- No activities were conducted this month.

## **TASK 6. UPDATED RESILIENCY EVALUATION**

- The H&H report was finalized in FY20.

## **TASK 7. PROGRAM MANAGEMENT**

- Executed a contract amendment for FY21 activities.
- Monthly progress reports have been submitted to EEA.
- Project currently on schedule and budget.

#### **SCOPE & BUDGET**

- No assistance from EEA is presently requested.
- A copy of the budget draw down / tracking table will be provided in future monthly progress reports as subtasks / tasks are completed and milestone deliverables are achieved.



## M E M O R A N D U M

**TO:** Brendan Callahan, Assistant Director of Planning – City of Peabody Massachusetts  
Michelle Rowden - Executive Office of Energy & Environmental Affairs (MassEEA)

**FROM:** Sarah DeStefano, Team Leader – Weston & Sampson

**DATE:** 9/1/20

**SUBJECT:** Monthly Progress Report  
Reporting Period of August 1, 2020 – August 31, 2020  
Report Number No. 7  
FY20-21 MVP Action Grant - Peabody North River Canal Resilient Wall and Riverwalk  
and Park – Phase II

---

Weston & Sampson is pleased to provide this summary of the status of engineering and design services related to the execution of the City of Peabody's FY20-FY21 North River Canal Resilient Wall and Riverwalk Grant Project (the Site), which is funded by the Massachusetts Executive Office of Energy & Environmental Affairs (MassEEA) through its Municipal Vulnerability Preparedness (MVP) Action Grant Program.

**TASK 1. SOUTH WALL STRUCTURAL DESIGN****1.1 Geotechnical**

- The geotechnical report was finalized in FY20.

**1.2 Geotechnical Survey**

- The survey base-map was finalized in FY20.

**1.3 Structural Analysis and Calculations**

- Weston & Sampson's Structural Team completed the design calculation package for the proposed North River Canal Wall, including sheet pile, helical pier/pile, boardwalk, and pedestrian timber bridge designs in FY20.

**1.3 Drawings and Technical Specifications**

- The Structural Team continues to advance the design drawings for chosen alternative and development of permitting specifications.
- **Final draft South Wall 75% Design Plans, including Drawings and Technical Specifications and Quantity Takeoffs and Cost Estimate & Narrative, are anticipated to be provided to the City for review and comment by close of business on September 16, 2020.** This will allow the City sufficient time to review and comment on the plans and for

Weston & Sampson to make any necessary revisions to the plan's prior submission to EEA by close of business on September 30, 2020.

#### **1.5 Quantity Takeoffs and Cost Estimation**

- No activities were conducted this month.

### **TASK 2: RIVERWALK 75% DESIGN**

#### **2.1 Draft Final Design**

- Weston & Sampson' Landscape Architectural Team continued to advance the draft 75% design for the Riverwalk and adjacent public open space opportunities at 24 Caller Street.

#### **2.2 Final Design**

- No activities were conducted this month.

### **Task 3: Environmental Permitting**

#### **3.1 Draft Permit Submittals**

- No activities were conducted this month.

#### **3.2 Finalize Permit Submittals**

- No activities were conducted this month.

### **Task 4: MPC Strategy for Soil Management and Cost Estimation**

#### **4.1 MPC Strategy for Soil Management and Cost Estimation**

- No activities were conducted this month.

#### **4.2 Hazmat Assessment of Foundations**

- Weston & Sampson continued to coordinate activities to conduct the hazardous materials assessment of foundations scheduled for demolition located within the Project limit on the 166R Main Street parcel.
- On August 14, 2020, Weston & Sampson submitted a letter to the City of Peabody's Conservation Agent, describing the proposed hazardous building materials assessment work and associated boring/test pit plan required as part of the Peabody North River MVP Grant, and why these minor activities should be exempted from 310 CMR 10. The subsurface investigatory work is located outside of wetland areas, but within the Riverfront Area, and is required in order to develop designs related to the improvements within the Riverfront Area and along the North River Canal.
- On August 19, 2020, the Conservation Commission agreed that the proposed exploratory temporary work for the project is exempt.
- Field activities are expected to be conducted on Friday, September 4, 2020.

#### **Task 5: COMMUNITY ENGAGEMENT**

- No activities were conducted this month.
- It is anticipated that virtual public engagement opportunities will be discussed at the September Status Meeting as the COVID related pandemic concerns continue.

#### **TASK 6. UPDATED RESILIENCY EVALUATION**

- The H&H report was finalized in FY20.

#### **TASK 7. PROGRAM MANAGEMENT**

- Monthly progress meetings and associated correspondence and/or coordination were conducted this month.
- Monthly progress reports have been submitted to EEA.
- Project currently on schedule and budget.

#### **SCOPE & BUDGET**

- No assistance from EEA is presently requested.
- A copy of the budget draw down / tracking table will be provided in future monthly progress reports as subtasks / tasks are completed and milestone deliverables are achieved.



# MEMORANDUM

**TO:** Brendan Callahan, Assistant Director of Planning – City of Peabody Massachusetts  
Michelle Rowden - Executive Office of Energy & Environmental Affairs (MassEEA)

**FROM:** Sarah DeStefano, Team Leader – Weston & Sampson

**DATE:** 10/5/20

**SUBJECT:** Monthly Progress Report  
Reporting Period of September 1, 2020 – September 30, 2020  
Report Number No. 8  
FY20-21 MVP Action Grant - Peabody North River Canal Resilient Wall and Riverwalk  
and Park – Phase II

---

Weston & Sampson is pleased to provide this summary of the status of engineering and design services related to the execution of the City of Peabody's FY20-FY21 North River Canal Resilient Wall and Riverwalk Grant Project (the Site), which is funded by the Massachusetts Executive Office of Energy & Environmental Affairs (MassEEA) through its Municipal Vulnerability Preparedness (MVP) Action Grant Program.

## **TASK 1. SOUTH WALL STRUCTURAL DESIGN**

### **1.1 Geotechnical**

- The geotechnical report was finalized in FY20.

### **1.2 Geotechnical Survey**

- The survey base-map was finalized in FY20.

### **1.3 Structural Analysis and Calculations**

- Weston & Sampson's Structural Team completed the design calculation package for the proposed North River Canal Wall, including sheet pile, helical pier/pile, boardwalk, and pedestrian timber bridge designs in FY20.

### **1.3 Drawings and Technical Specifications**

- The Structural Team continues to advance the design drawings for chosen alternative and development of permitting specifications, including:
  - Updated sheet piling plans for 75% submission.
  - Prepared technical specifications for 75% submission.
  - Coordination of wall elevations and walkway grading with Landscape Architect's.

- **Final South Wall 75% Design Plans, including Drawings and Technical Specifications and Quantity Takeoffs and Cost Estimate & Narrative**, were provided to the City for submittal to EEA on September 30, 2020.

#### 1.5 Quantity Takeoffs and Cost Estimation

- Completed this month for submission to EEA.

### TASK 2: RIVERWALK 75% DESIGN

#### 2.1 Draft Final Design

- Weston & Sampson' Landscape Architectural Team continued to advance the draft 75% design for the Riverwalk and adjacent public open space opportunities at 24 Caller Street, including the following:
  - External meetings with City staff to determine standard details and/or specifications
  - Design development as it pertains to the following:
    - Pathway layout refinement
    - Street crossing refinement
    - Coordination with structural re: wall location, dimensioning, etc.
    - Site grading: existing grades vs conceptual with new canal wall
    - Stormwater management concepts
    - Internal hydrology coordination
    - Surface materials refinement

#### 2.2 Final Design

- No activities were conducted this month.

### Task 3: Environmental Permitting

#### 3.1 Draft Permit Submittals

- No activities were conducted this month.

#### 3.2 Finalize Permit Submittals

- No activities were conducted this month.

### Task 4: MPC Strategy for Soil Management and Cost Estimation

#### 4.1 MPC Strategy for Soil Management and Cost Estimation

- No activities were conducted this month.

#### 4.2 Hazmat Assessment of Foundations

- Weston & Sampson continued to coordinate activities to conduct the hazardous materials assessment of foundations scheduled for demolition located within the Project limit on the 166R Main Street parcel. Field activities were conducted on Friday, September 4, 2020.

#### **Task 5: COMMUNITY ENGAGEMENT**

- No activities were conducted this month.
- Virtual public engagement opportunities were discussed at the September Status Meeting as the COVID related pandemic concerns continue. The City would like to advance acquisition negotiations with the private property owners prior to hosting a public meeting.

#### **TASK 6. UPDATED RESILIENCY EVALUATION**

- The H&H report was finalized in FY20.

#### **TASK 7. PROGRAM MANAGEMENT**

- Monthly progress meetings and associated correspondence and/or coordination were conducted this month.
- Monthly progress reports have been submitted to EEA.
- Project currently on schedule and budget.

#### **SCOPE & BUDGET**

- No assistance from EEA is presently requested.
- A copy of the budget draw down / tracking table will be provided in future monthly progress reports as subtasks / tasks are completed and milestone deliverables are achieved.



# MEMORANDUM

**TO:** Brendan Callahan, Assistant Director of Planning – City of Peabody Massachusetts  
Michelle Rowden - Executive Office of Energy & Environmental Affairs (MassEEA)

**FROM:** Sarah DeStefano, Team Leader – Weston & Sampson

**DATE:** 11/2/20

**SUBJECT:** Monthly Progress Report  
Reporting Period of October 1, 2020 – October 31, 2020  
Report Number No. 9  
FY20-21 MVP Action Grant - Peabody North River Canal Resilient Wall and Riverwalk  
and Park – Phase II

---

Weston & Sampson is pleased to provide this summary of the status of engineering and design services related to the execution of the City of Peabody's FY20-FY21 North River Canal Resilient Wall and Riverwalk Grant Project (the Site), which is funded by the Massachusetts Executive Office of Energy & Environmental Affairs (MassEEA) through its Municipal Vulnerability Preparedness (MVP) Action Grant Program.

## **TASK 1. SOUTH WALL STRUCTURAL DESIGN**

### **1.1 Geotechnical**

- The geotechnical report was finalized in FY20.

### **1.2 Geotechnical Survey**

- The survey base-map was finalized in FY20.

### **1.3 Structural Analysis and Calculations**

- Weston & Sampson's Structural Team completed the design calculation package for the proposed North River Canal Wall, including sheet pile, helical pier/pile, boardwalk, and pedestrian timber bridge designs in FY20.

### **1.3 Drawings and Technical Specifications**

- The Structural Team continues to advance the design drawings for chosen alternative and development of permitting specifications, including:
  - Updated sheet piling plans for 75% submission.
  - Prepared technical specifications for 75% submission.
- Coordination of wall elevations and walkway grading with Landscape Architects.
- Prepared updated drawings for 75% Landscape Architecture Progress Set which included:

- Boardwalk framing plan, sections, and details
- Bridge over Strongwater Brook plan, elevation, and section.
- Prepared calculations for main framing members of the boardwalk, overlook structures, and bridge over Strongwater Brook.
- **Final South Wall 75% Design Plans, including Drawings and Technical Specifications and Quantity Takeoffs and Cost Estimate & Narrative**, were provided to the City for submittal to EEA on September 30, 2020.

#### 1.5 Quantity Takeoffs and Cost Estimation

- Completed September 2020 for submission to EEA.

### TASK 2: RIVERWALK 75% DESIGN

#### 2.1 Draft Final Design

- Weston & Sampson' Landscape Architectural Team continued to advance the draft 75% design for the Riverwalk and adjacent public open space opportunities at 24 Caller Street, including the following:
  - External meetings with City staff to determine standard details and/or specifications and received general feedback on proposed 75% design plans
  - Design development as it pertains to the following:
    - Pathway layout refinement
    - Street crossing refinement
    - Coordination with structural re: wall location, dimensioning, bridge over Strongwater Brook etc.
    - Site grading: existing grades vs conceptual with new canal wall
    - Stormwater management concepts
    - Internal hydrology coordination
    - Surface materials refinement
- Final Draft 75% designs are anticipated to be submitted to the City for review in November. The 75% Riverwalk Design plans have been delayed a couple of weeks as the City and Weston & Sampson coordinate and incorporate feedback and make applicable changes to the 75% design. We do not anticipate this to impact the overall project schedule.

#### 2.2 Final Design

- No activities were conducted this month.

### Task 3: Environmental Permitting

#### 3.1 Draft Permit Submittals

- No activities were conducted this month.

#### 3.2 Finalize Permit Submittals

- No activities were conducted this month.

#### **Task 4: MPC Strategy for Soil Management and Cost Estimation**

##### **4.1 MPC Strategy for Soil Management and Cost Estimation**

- Coordination activities commenced this month to support the 75% design and permitting associated with the proposed repairs to the canal wall and the construction of the Riverwalk. Weston & Sampson's environmental staff is assisting the permitting and design teams with respect to recommendations to address potential environmental (i.e. contamination) concerns associated with the canal wall and Riverwalk design, including but not limited to, updating preliminary cost estimates associated with Massachusetts Contingency Plan (310 CMR 40.000) compliance strategies and anticipated soil management/disposal requirements associated with the 75% design.

##### **4.2 Hazmat Assessment of Foundations**

- Weston & Sampson continued to conduct the hazardous building materials assessment of foundations scheduled for demolition located within the Project limit on the 166R Main Street parcel. Activities included, but not limited to, preparation of a memo documenting the findings of the above referenced hazardous materials assessment, calculating volume estimates of concrete, and associated cost estimates for disposal.

#### **Task 5: COMMUNITY ENGAGEMENT**

- No activities were conducted this month.
- Virtual public engagement opportunities were discussed at the October Status Meeting as the COVID related pandemic concerns continue. The City would like to advance acquisition negotiations with the private property owners prior to hosting a public meeting. The City is targeting December for a tentative, virtual public meeting date to receive feedback from the public on the draft final 75% designs of the Riverwalk. We do not anticipate this to impact the overall project schedule.

#### **TASK 6. UPDATED RESILIENCY EVALUATION**

- The H&H report was finalized in FY20.

#### **TASK 7. PROGRAM MANAGEMENT**

- Monthly progress meetings and associated correspondence and/or coordination were conducted this month.
- Monthly progress reports have been submitted to EEA.



- Project currently on schedule and budget overall. The Final Draft 75% Riverwalk Design plans are delayed a couple of weeks as the City and Weston & Sampson coordinate and incorporate feedback and make applicable changes to the 75% design. In addition, virtual public engagement opportunities are being discussed as the COVID related pandemic concerns continue. The City would like to advance acquisition negotiations with the private property owners prior to hosting a public meeting. The City is targeting December for a tentative, virtual public meeting date to receive feedback from the public on the draft final 75% designs of the Riverwalk. We do not anticipate these delays to impact the overall project schedule.

## **SCOPE & BUDGET**

- No assistance from EEA is presently requested.
- A copy of the budget draw down / tracking table will be provided in future monthly progress reports as subtasks / tasks are completed and milestone deliverables are achieved.

# MEMORANDUM

**TO:** Brendan Callahan, Assistant Director of Planning – City of Peabody Massachusetts  
Michelle Rowden - Executive Office of Energy & Environmental Affairs (MassEEA)

**FROM:** Sarah DeStefano, Team Leader – Weston & Sampson

**DATE:** 12/3/20

**SUBJECT:** Monthly Progress Report  
Reporting Period of November 1, 2020 – November 30, 2020  
Report Number No. 10  
FY20-21 MVP Action Grant - Peabody North River Canal Resilient Wall and Riverwalk and Park – Phase II

Weston & Sampson is pleased to provide this summary of the status of engineering and design services related to the execution of the City of Peabody’s FY20-FY21 North River Canal Resilient Wall and Riverwalk Grant Project (the Site), which is funded by the Massachusetts Executive Office of Energy & Environmental Affairs (MassEEA) through its Municipal Vulnerability Preparedness (MVP) Action Grant Program.

## TASK 1. SOUTH WALL STRUCTURAL DESIGN

### 1.1 Geotechnical

- The geotechnical report was finalized in FY20.

### 1.2 Geotechnical Survey

- The survey base-map was finalized in FY20.

### 1.3 Structural Analysis and Calculations

- Weston & Sampson’s Structural Team completed the design calculation package for the proposed North River Canal Wall, including sheet pile, helical pier/pile, boardwalk, and pedestrian timber bridge designs in FY20.

### 1.3 Drawings and Technical Specifications

- The Structural Team continues to advance the design drawings for chosen alternative and development of permitting specifications, including:
  - Preparation of updated drawings for 75% Landscape Architecture / Riverwalk Progress Set which included:
    - Boardwalk framing plan, sections, and details
    - Bridge over Strongwater Brook plan, elevation, and section.

- Prepared calculations for main framing members of the boardwalk, overlook structures, and bridge over Strongwater Brook.
- **Final South Wall 75% Design Plans, including Drawings and Technical Specifications and Quantity Takeoffs and Cost Estimate & Narrative**, were provided to the City for submittal to EEA on September 30, 2020.

#### 1.5 Quantity Takeoffs and Cost Estimation

- Completed September 2020 for submission to EEA.

### TASK 2: RIVERWALK 75% DESIGN

#### 2.1 Draft Final Design

- Weston & Sampson' Landscape Architectural Team continued to advance the draft 75% design for the Riverwalk and adjacent public open space opportunities at 24 Caller Street, including the following:
  - Four (4) external meetings with City staff to facilitate full site plan design review and to receive general feedback on proposed 75% design plans
  - Design development as it pertains to the following:
    - Pathway layout refinement
    - Street crossing and shared driveway refinement
    - Coordination with structural team re: bridge over Strongwater Brook etc.
    - Site grading: slope to sheet pile wall coordination
    - Stormwater management coordination
    - Environmental / MCP coordination
    - Internal hydrology coordination / scour and erosion coordination.
    - Surface materials refinement
- Draft Final 75% designs were submitted to the City for review in November. There is a meeting scheduled for Monday, December 14th between Weston & Sampson and multiple personnel from the City to go over the Draft Final 75% Riverwalk Design plans. Although the final 75% plans have been delayed several weeks as the City and Weston & Sampson coordinate and incorporate feedback and make applicable changes to the draft 75% design, we do not anticipate this to impact the overall project schedule.

#### 2.2 Final Design

- Final Design activities commenced at the end of this month.

### Task 3: Environmental Permitting

#### 3.1 Draft Permit Submittals

- No activities were conducted this month. Activities are anticipated to commence in December 2020.



### **3.2 Finalize Permit Submittals**

- No activities were conducted this month.

## **Task 4: MPC Strategy for Soil Management and Cost Estimation**

### **4.1 MPC Strategy for Soil Management and Cost Estimation**

- Coordination activities continued this month to support the 75% design, stormwater management and permitting associated with the proposed repairs to the canal wall and the construction of the Riverwalk. Weston & Sampson's environmental staff is assisting the permitting and design teams with respect to recommendations to address potential environmental (i.e. contamination) concerns associated with the canal wall and Riverwalk design, including but not limited to, updating preliminary cost estimates associated with Massachusetts Contingency Plan (310 CMR 40.000) compliance strategies and anticipated soil management/disposal requirements associated with the 75% design.

### **4.2 Hazmat Assessment of Foundations**

- Weston & Sampson continued to conduct the hazardous building materials assessment of foundations scheduled for demolition located within the Project limit on the 166R Main Street parcel. Activities included, but not limited to, preparation of a memo documenting the findings of the above referenced hazardous materials assessment, calculating volume estimates of concrete, and associated cost estimates for disposal. The report is expected to be finalized and submitted in December 2020.

## **Task 5: COMMUNITY ENGAGEMENT**

- No activities were conducted this month.
- Virtual public engagement opportunities were discussed at the October Status Meeting as the COVID related pandemic concerns continue. The City would like to advance acquisition negotiations with the private property owners prior to hosting a public meeting. The City is targeting January 12, 2021 for a virtual public meeting date to receive feedback from the public on the draft final 75% designs of the Riverwalk. We do not anticipate this delay to impact the overall project schedule.

## **TASK 6. UPDATED RESILIENCY EVALUATION**

- The H&H report was finalized in FY20.

## **TASK 7. PROGRAM MANAGEMENT**

- Monthly progress meetings and associated correspondence and/or coordination were conducted this month.

- Monthly progress reports have been submitted to EEA.
- Project currently on schedule and budget overall. The Final Draft 75% Riverwalk Design plans are delayed several weeks as the City and Weston & Sampson coordinate and incorporate feedback and make applicable changes to the 75% design. In addition, virtual public engagement opportunities are being discussed as the COVID related pandemic concerns continue. The City would like to advance acquisition negotiations with the private property owners prior to hosting a public meeting. The City is targeting January 12, 2021 for a tentative, virtual public meeting date to receive feedback from the public on the draft final 75% designs of the Riverwalk. We do not anticipate these delays to impact the overall project schedule.

## **SCOPE & BUDGET**

- No assistance from EEA is presently requested.
- A copy of the budget draw down / tracking table will be provided in future monthly progress reports as subtasks / tasks are completed and milestone deliverables are achieved.

## M E M O R A N D U M

**TO:** Brendan Callahan, Assistant Director of Planning – City of Peabody Massachusetts  
Michelle Rowden - Executive Office of Energy & Environmental Affairs (MassEEA)

**FROM:** Sarah DeStefano, Team Leader – Weston & Sampson

**DATE:** 1/8/21

**SUBJECT:** Monthly Progress Report  
Reporting Period of December 1, 2020 – December 31, 2020  
Report Number No. 11  
FY20-21 MVP Action Grant - Peabody North River Canal Resilient Wall and Riverwalk  
and Park – Phase II

---

Weston & Sampson is pleased to provide this summary of the status of engineering and design services related to the execution of the City of Peabody's FY20-FY21 North River Canal Resilient Wall and Riverwalk Grant Project (the Site), which is funded by the Massachusetts Executive Office of Energy & Environmental Affairs (MassEEA) through its Municipal Vulnerability Preparedness (MVP) Action Grant Program.

**TASK 1. SOUTH WALL STRUCTURAL DESIGN****1.1 Geotechnical**

- The geotechnical report was finalized in FY20.

**1.2 Geotechnical Survey**

- The survey base-map was finalized in FY20.

**1.3 Structural Analysis and Calculations**

- Weston & Sampson's Structural Team completed the design calculation package for the proposed North River Canal Wall, including sheet pile, helical pier/pile, boardwalk, and pedestrian timber bridge designs in FY20.

**1.3 Drawings and Technical Specifications**

- The Structural Team continues to coordinate with the Landscape Architect team to advance the design drawings for chosen alternative and development of permitting specifications, including:
  - Preparation of updated drawings for 75% Landscape Architecture / Riverwalk Progress Set which included:
    - Boardwalk framing plan, sections, and details
    - Bridge over Strongwater Brook plan, elevation, and section.



- Prepared calculations for main framing members of the boardwalk, overlook structures, and bridge over Strongwater Brook.
- **Final South Wall 75% Design Plans, including Drawings and Technical Specifications and Quantity Takeoffs and Cost Estimate & Narrative**, were provided to the City for submittal to EEA on September 30, 2020.

#### 1.5 Quantity Takeoffs and Cost Estimation

- Completed September 2020 for submission to EEA.

### TASK 2: RIVERWALK 75% DESIGN

#### 2.1 Draft Final Design

- Weston & Sampson' Landscape Architectural Team continued to advance the draft 75% design for the Riverwalk and adjacent public open space opportunities at 24 Caller Street, including the following:
  - External meetings with City staff to facilitate full site plan design review and to receive general feedback on proposed 75% design plans
  - Design development as it pertains to the following:
    - Pathway layout refinement
    - Street crossing and shared driveway refinement
    - Coordination with structural team re: bridge over Strongwater Brook etc.
    - Site grading: slope to sheet pile wall coordination
    - Stormwater management coordination
    - Environmental / MCP coordination
    - Internal hydrology coordination / scour and erosion coordination. Weston & Sampson is in the process of performing scour analyses in order to maximize the earthen portions of the wall. We understand that EEA and MassDEP, etc. will require such justification, as we have been required to do such evaluations for other projects. This will be incorporated into the final 75% design.
    - Surface materials refinement
    - 24 Caller St park design concepts and graphics
  - Construction documentation development and internal coordination with environmental, structural, electrical and civil teams.
- Draft Final 75% designs are were submitted to the City for review in November. There was a meeting on Monday, December 14th between Weston & Sampson and multiple personnel from the City to go over the Draft Final 75% Riverwalk Design plans. Although the final 75% plans have been delayed several weeks as the City, Weston & Sampson continues to coordinate and incorporate feedback and make applicable changes to the draft 75% design, and we do not anticipate this to impact the overall project schedule.

## 2.2 Final Design

- Final Design activities commenced at the end of November.

### Task 3: Environmental Permitting

#### 3.1 Draft Permit Submittals

- Permitting activities commenced in December 2020. Permits are being drafted based on 75% draft design. As plans move closer to finalization, updates will be made as needed.
- Given the stormwater constraints and contamination at the Site, the permitting team will schedule a meeting with DEP prior to submitting any permits.

#### 3.2 Finalize Permit Submittals

- No activities were conducted this month.

### Task 4: MPC Strategy for Soil Management and Cost Estimation

#### 4.1 MPC Strategy for Soil Management and Cost Estimation

- Coordination activities continued this month to support the 75% design, stormwater management and permitting associated with the proposed repairs to the canal wall and the construction of the Riverwalk. Weston & Sampson's environmental staff is assisting the permitting and design teams with respect to recommendations to address potential environmental (i.e. contamination) concerns associated with the canal wall and Riverwalk design, including but not limited to, updating preliminary cost estimates associated with Massachusetts Contingency Plan (310 CMR 40.000) compliance strategies and anticipated soil management/disposal requirements associated with the finalization of the 75% design.
- Review, tabulation, and figures of existing data subsurface data to assess data gaps and support of off-site disposal.

#### 4.2 Hazmat Assessment of Foundations

- Weston & Sampson finalized the hazardous building materials assessment of foundations scheduled for demolition located within the Project limit on the 166R Main Street parcel. Activities included, but not limited to, preparation of a memo documenting the findings of the above referenced hazardous materials assessment, calculating volume estimates of concrete, and associated cost estimates for disposal. The report was finalized and submitted to the City on December 22, 2020.

### Task 5: COMMUNITY ENGAGEMENT

- The City and Weston & Sampson commenced community engagement planning activities this month.

- Virtual public engagement opportunities, notification and presentation preparation were discussed and advanced. The City is hosting the virtual public meeting on January 12, 2021 to receive feedback from the public on the draft final 75% designs of the Riverwalk.
- Notification to the public commenced on Monday, December 28, 2020.
  - <https://www.eventbrite.com/e/north-river-resiliency-canal-wall-and-riverwalk-project-webinar-tickets-132463077631>
  - <https://www.peabody-ma.gov/meetings/NRiverCanalWallRiverwalkPublicMeetingInvite.pdf>
  - <https://peabody-ma.gov/event%20calendar.html>

#### **TASK 6. UPDATED RESILIENCY EVALUATION**

- The H&H report was finalized in FY20.

#### **TASK 7. PROGRAM MANAGEMENT**

- Monthly progress meetings and associated correspondence and/or coordination were conducted this month.
- Monthly progress reports have been submitted to EEA.
- Project currently on schedule and budget overall. The Final Draft 75% Riverwalk Design plans are delayed several weeks as the City and Weston & Sampson coordinate and incorporate feedback and make applicable changes to the 75% design. In addition, virtual public engagement will be conducted in mid-January to receive feedback from the public on the draft final 75% designs of the Riverwalk. We do not anticipate these delays to impact the overall project schedule.

#### **SCOPE & BUDGET**

- No assistance from EEA is presently requested.
- A copy of the budget draw down / tracking table will be provided in future monthly progress reports as subtasks / tasks are completed and milestone deliverables are achieved.



# MEMORANDUM

**TO:** Brendan Callahan, Assistant Director of Planning – City of Peabody Massachusetts  
Michelle Rowden - Executive Office of Energy & Environmental Affairs (MassEEA)

**FROM:** Sarah DeStefano, Team Leader – Weston & Sampson

**DATE:** 2/3/21

**SUBJECT:** Monthly Progress Report  
Reporting Period of January 1, 2021 – January 31, 2021  
Report Number No. 12  
FY20-21 MVP Action Grant - Peabody North River Canal Resilient Wall and Riverwalk and Park – Phase II

Weston & Sampson is pleased to provide this summary of the status of engineering and design services related to the execution of the City of Peabody’s FY20-FY21 North River Canal Resilient Wall and Riverwalk Grant Project (the Site), which is funded by the Massachusetts Executive Office of Energy & Environmental Affairs (MassEEA) through its Municipal Vulnerability Preparedness (MVP) Action Grant Program.

## TASK 1. SOUTH WALL STRUCTURAL DESIGN

### 1.1 Geotechnical

- The geotechnical report was finalized in FY20.

### 1.2 Geotechnical Survey

- The survey base-map was finalized in FY20.

### 1.3 Structural Analysis and Calculations

- Weston & Sampson’s Structural Team completed the design calculation package for the proposed North River Canal Wall, including sheet pile, helical pier/pile, boardwalk, and pedestrian timber bridge designs in FY20.

### 1.3 Drawings and Technical Specifications

- The Structural Team continues to coordinate with the Landscape Architect team to advance the design drawings for chosen alternative and development of permitting specifications, including:
  - Preparation of updated drawings for 75% Landscape Architecture / Riverwalk Progress Set which included:
    - Boardwalk framing plan, sections, and details
    - Bridge over Strongwater Brook plan, elevation, and section.

- Prepared calculations for main framing members of the boardwalk, overlook structures, and bridge over Strongwater Brook.
- **Final South Wall 75% Design Plans, including Drawings and Technical Specifications and Quantity Takeoffs and Cost Estimate & Narrative**, were provided to the City for submittal to EEA on September 30, 2020.

#### 1.5 Quantity Takeoffs and Cost Estimation

- Completed September 2020 for submission to EEA.

### TASK 2: RIVERWALK 75% DESIGN

#### 2.1 Draft Final Design

- Draft Final 75% designs were submitted to the City for review in November. There was a meeting on Monday, December 14th between Weston & Sampson and multiple personnel from the City to go over the Draft Final 75% Riverwalk Design plans. Although the final 75% plans have been delayed several weeks as the City, Weston & Sampson continues to coordinate and incorporate feedback and make applicable changes to the draft 75% design, and we do not anticipate this to impact the overall project schedule.

#### 2.2 Final Design

- Final Design activities commenced at the end of November.
- The City and Weston & Sampson prepared for and hosted a virtual public meeting on January 12, 2021 and received feedback from the public on the draft designs of the Riverwalk. A summary of results from the on-line polling conducted throughout the virtual meeting and a copy of the presentation are included as separate documents.
- Weston & Sampson' Landscape Architectural Team continues to advance the final 75% design for the Riverwalk and adjacent public open space opportunities at 24 Caller Street, including but not limited to the following:
  - External meetings with City staff to facilitate incorporating the applicable feedback received from the public and making appropriate changes to the 75% design to finalize by the end of February 2021.
  - Concept design refinement for 24 Caller St parcel.
  - Coordination with structural team re: bridge, boardwalk, etc.
  - Site grading coordination
  - Stormwater management coordination
  - Environmental / MCP coordination
  - Internal hydrology / scour analysis and erosion coordination. Weston & Sampson is in the process of completing scour analyses and a preliminary threshold channel design to determine the suitable materials needed to compose the earthen bank. We understand that EEA and MassDEP, etc. will require such justification, as we have been required to do such evaluations for other projects. This will be incorporated into the final 75% design.

- Scour analysis findings were also used to verify sheet pile design for the scour.
- Construction documentation development and internal coordination with environmental, structural, electrical and civil teams.

### **Task 3: Environmental Permitting**

#### **3.1 Draft Permit Submittals**

- Permitting activities commenced in December 2020.
- Permits are being drafted based on 75% draft design.
- Permitting team has been coordinating with MassDEP regarding permit submittal requirements.
- Assembly of the required permitting materials commenced, including but not limited to, generation of maps/figures / reviewing local conservation commission submission requirements, etc.
- As 75% design plans move closer to finalization, updates will be made as needed.
- Given the stormwater constraints, shallow groundwater and contamination at the Site, the permitting team will schedule a meeting with DEP prior to submitting any permits.

#### **3.2 Finalize Permit Submittals**

- No activities were conducted this month.

### **Task 4: MPC Strategy for Soil Management and Cost Estimation**

#### **4.1 MPC Strategy for Soil Management and Cost Estimation**

- Coordination activities continued this month to support the 75% design, stormwater management and permitting associated with the proposed repairs to the canal wall and the construction of the Riverwalk. Weston & Sampson's environmental staff is assisting the permitting and design teams with respect to recommendations to address potential environmental (i.e. contamination) concerns associated with the canal wall and Riverwalk design, including but not limited to, updating preliminary cost estimates associated with Massachusetts Contingency Plan (310 CMR 40.000) compliance strategies and anticipated soil management/disposal requirements associated with the finalization of the 75% design.

#### **4.2 Hazmat Assessment of Foundations**

- Weston & Sampson finalized the hazardous building materials assessment report and submitted to the City on December 22, 2020.

### **Task 5: COMMUNITY ENGAGEMENT**

- The City and Weston & Sampson commenced community engagement planning and preparation activities in December 2020 and scheduled a public meeting for January 12, 2021.



- Notification to the public commenced on Monday, December 28, 2020.
  - <https://www.eventbrite.com/e/north-river-resiliency-canal-wall-and-riverwalk-project-webinar-tickets-132463077631>
  - <https://www.peabody-ma.gov/meetings/NRiverCanalWallRiverwalkPublicMeetingInvite.pdf>
  - <https://peabody-ma.gov/event%20calendar.html>
- The City hosted the virtual public meeting on January 12, 2021.
- 72 people registered to attend the meeting and approximately 38 actively participated.
- At the meeting, topics discussed included project background, design progress updates, and programming options for 24 Caller Street. Attendees shared great feedback through polls and the Q&A sessions, which will inform final 75% designs of the Riverwalk.
- A summary of results from the on-line polling conducted throughout the virtual meeting and a copy of the presentation are included as separate documents.
- A video recording of the webinar will also be uploaded to the City's website.

#### **TASK 6. UPDATED RESILIENCY EVALUATION**

- The H&H report was finalized in FY20.

#### **TASK 7. PROGRAM MANAGEMENT**

- Monthly progress meetings and associated correspondence and/or coordination were conducted this month.
- Monthly progress reports have been submitted to EEA.
- Project currently on schedule and budget overall. The Final Draft 75% Riverwalk Design plans are delayed several weeks as the City and Weston & Sampson coordinate and incorporate feedback and make applicable changes to the 75% design. In addition, the first virtual public engagement was conducted in mid-January to receive feedback from the public on the draft final 75% designs of the Riverwalk. We do not anticipate these delays to impact the overall project schedule.

#### **SCOPE & BUDGET**

- No assistance from EEA is presently requested.
- A copy of the budget draw down / tracking table will be provided in future monthly progress reports as subtasks / tasks are completed and milestone deliverables are achieved.

## M E M O R A N D U M

**TO:** Brendan Callahan, Assistant Director of Planning – City of Peabody Massachusetts  
Michelle Rowden - Executive Office of Energy & Environmental Affairs (MassEEA)

**FROM:** Sarah DeStefano, Team Leader – Weston & Sampson

**DATE:** 3/9/21

**SUBJECT:** Monthly Progress Report  
Reporting Period of February 1, 2021 – February 28, 2021  
Report Number No. 13  
FY20-21 MVP Action Grant - Peabody North River Canal Resilient Wall and Riverwalk  
and Park – Phase II

---

Weston & Sampson is pleased to provide this summary of the status of engineering and design services related to the execution of the City of Peabody's FY20-FY21 North River Canal Resilient Wall and Riverwalk Grant Project (the Site), which is funded by the Massachusetts Executive Office of Energy & Environmental Affairs (MassEEA) through its Municipal Vulnerability Preparedness (MVP) Action Grant Program.

**TASK 1. SOUTH WALL STRUCTURAL DESIGN****1.1 Geotechnical**

- The geotechnical report was finalized in FY20.

**1.2 Geotechnical Survey**

- The survey base-map was finalized in FY20.

**1.3 Structural Analysis and Calculations**

- Weston & Sampson's Structural Team completed the design calculation package for the proposed North River Canal Wall, including sheet pile, helical pier/pile, boardwalk, and pedestrian timber bridge designs in FY20.

**1.3 Drawings and Technical Specifications**

- The Structural Team continues to coordinate with the Landscape Architect team to advance the design drawings for chosen alternative and development of permitting specifications, including:
  - Preparation of updated drawings for 75% Landscape Architecture / Riverwalk Progress Set which included:
    - Boardwalk framing plan, sections, and details
    - Bridge over Strongwater Brook plan, elevation, and section.

- Prepared calculations for main framing members of the boardwalk, overlook structures, and bridge over Strongwater Brook.
- **Final South Wall 75% Design Plans, including Drawings and Technical Specifications and Quantity Takeoffs and Cost Estimate & Narrative**, were provided to the City for submittal to EEA on September 30, 2020.

#### 1.5 Quantity Takeoffs and Cost Estimation

- Completed September 2020 for submission to EEA.

### TASK 2: RIVERWALK 75% DESIGN

#### 2.1 Draft Final Design

- Draft Final 75% designs were submitted to the City for review in November. There was a meeting on Monday, December 14th between Weston & Sampson and multiple personnel from the City to go over the Draft Final 75% Riverwalk Design plans. Although the final 75% plans have been delayed several weeks as the City, Weston & Sampson continues to coordinate and incorporate feedback and make applicable changes to the draft 75% design, and we do not anticipate this to impact the overall project schedule.

#### 2.2 Final Design

- Final Design activities commenced at the end of November.
- The City and Weston & Sampson prepared for and hosted a virtual public meeting on January 12, 2021 and received feedback from the public on the draft designs of the Riverwalk. A summary of results from the on-line polling conducted throughout the virtual meeting and a copy of the presentation are included as separate documents.
- Weston & Sampson' Landscape Architectural Team continues to advance the final 75% design for the Riverwalk and adjacent public open space opportunities at 24 Caller Street, including but not limited to the following:
  - External meetings with City staff to facilitate incorporating the applicable feedback received from the public and making appropriate changes to the 75% design to finalize in early March 2021.
  - Concept design refinement for 24 Caller St parcel.
  - Coordination with structural team re: bridge and boardwalk, as well as updating plans for sheet pile / vegetated slope design for scour.
  - Site grading coordination
  - Stormwater management coordination
  - Environmental / MCP coordination
  - Construction documentation development and internal coordination with environmental, structural, electrical and civil teams.
  - Site visit to inspect southern slope conditions at 24 Caller



### Task 3: Environmental Permitting

#### 3.1 Draft Permit Submittals

- Permitting activities commenced in December 2020.
- Permits are being drafted based on 75% draft design.
- Completed a preliminary analysis to quantify the amount of fill being placed in the floodplain vs. the amount of material being removed from the floodplain as part of this project.
- Permitting team has been coordinating with MassDEP regarding permit submittal requirements and virtually with regulators and the City's Conservation Agent and City Engineer on February 25, 2021 to review the proposed stormwater management strategy for the project. The regulating community agreed that traditional infiltration through recharge would not work well at the Site given the contamination and shallow groundwater constraints in the area. Rachel Freed, Deputy Regional Director – Bureau of Water Resources (NERO), requested Weston & Sampson include a detailed discussion regarding the “maximum extent practical approach” when filing permits with MassDEP. Weston & Sampson also needs to address upland sheet flow and flood flow erosive concerns and how the vegetative slope stability will be managed.
- Continue to assemble of the required permitting materials commenced, including but not limited to, generation of maps/figures / reviewing local conservation commission submission requirements, etc.
- As 75% design plans move closer to finalization, updates will be made as needed.

#### 3.2 Finalize Permit Submittals

- No activities were conducted this month.

### Task 4: MPC Strategy for Soil Management and Cost Estimation

#### 4.1 MPC Strategy for Soil Management and Cost Estimation

- Coordination activities continued this month to support the 75% design, stormwater management and permitting associated with the proposed repairs to the canal wall and the construction of the Riverwalk. Weston & Sampson's environmental staff is assisting the permitting and design teams with respect to recommendations to address potential environmental (i.e. contamination) concerns associated with the canal wall and Riverwalk design, including but not limited to, updating preliminary cost estimates associated with Massachusetts Contingency Plan (310 CMR 40.000) compliance strategies and anticipated soil management/disposal requirements associated with the finalization of the 75% design.

#### 4.2 Hazmat Assessment of Foundations

- Weston & Sampson finalized the hazardous building materials assessment report and submitted to the City on December 22, 2020.

**Task 5: COMMUNITY ENGAGEMENT**

- The City and Weston & Sampson commenced community engagement planning and preparation activities in December 2020 and scheduled a public meeting for January 12, 2021.
- Notification to the public commenced on Monday, December 28, 2020.
- The City hosted the virtual public meeting on January 12, 2021.
- 72 people registered to attend the meeting and approximately 38 actively participated.
- At the meeting, topics discussed included project background, design progress updates, and programming options for 24 Caller Street. Attendees shared great feedback through polls and the Q&A sessions, which will inform final 75% designs of the Riverwalk.
- A summary of results from the on-line polling conducted throughout the virtual meeting and a copy of the presentation are included as separate documents.
- A video recording of the webinar will also be uploaded to the City's website.

**TASK 6. UPDATED RESILIENCY EVALUATION**

- The H&H report was finalized in FY20.

**TASK 7. PROGRAM MANAGEMENT**

- Monthly progress meetings and associated correspondence and/or coordination were conducted this month.
- Monthly progress reports have been submitted to EEA.
- Project currently on schedule and budget overall. The Final Draft 75% Riverwalk Design plans are delayed several weeks as the City and Weston & Sampson coordinate and incorporate feedback and make applicable changes to the 75% design. In addition, the first virtual public engagement was conducted in mid-January to receive feedback from the public on the draft final 75% designs of the Riverwalk. We do not anticipate these delays to impact the overall project schedule.

**SCOPE & BUDGET**

- No assistance from EEA is presently requested.
- A copy of the budget draw down / tracking table will be provided in future monthly progress reports as subtasks / tasks are completed and milestone deliverables are achieved.

## M E M O R A N D U M

**TO:** Brendan Callahan, Assistant Director of Planning – City of Peabody Massachusetts  
Michelle Rowden - Executive Office of Energy & Environmental Affairs (MassEEA)

**FROM:** Sarah DeStefano, Team Leader – Weston & Sampson

**DATE:** 4/1/21

**SUBJECT:** Monthly Progress Report  
Reporting Period of March 1, 2021 – March 31, 2021  
Report Number No. 14  
FY20-21 MVP Action Grant - Peabody North River Canal Resilient Wall and Riverwalk  
and Park – Phase II

---

Weston & Sampson is pleased to provide this summary of the status of engineering and design services related to the execution of the City of Peabody's FY20-FY21 North River Canal Resilient Wall and Riverwalk Grant Project (the Site), which is funded by the Massachusetts Executive Office of Energy & Environmental Affairs (MassEEA) through its Municipal Vulnerability Preparedness (MVP) Action Grant Program.

**TASK 1. SOUTH WALL STRUCTURAL DESIGN****1.1 Geotechnical**

- The geotechnical report was finalized in FY20.

**1.2 Geotechnical Survey**

- The survey base-map was finalized in FY20.

**1.3 Structural Analysis and Calculations**

- Weston & Sampson's Structural Team completed the design calculation package for the proposed North River Canal Wall, including sheet pile, helical pier/pile, boardwalk, and pedestrian timber bridge designs in FY20.

**1.3 Drawings and Technical Specifications**

- The Structural Team continues to coordinate with the Landscape Architect team to advance the design drawings for chosen alternative and development of permitting specifications, including:
  - Preparation of updated drawings for Final 75% Landscape Architecture / Riverwalk Progress Set which included:
    - Boardwalk framing plan, sections, and details
  - Updating cost estimates for construction



- **Final South Wall 75% Design Plans, including Drawings and Technical Specifications and Quantity Takeoffs and Cost Estimate & Narrative**, were provided to the City for submittal to EEA on September 30, 2020.

#### 1.5 Quantity Takeoffs and Cost Estimation

- Completed September 2020 for submission to EEA.

### TASK 2: RIVERWALK 75% DESIGN

#### 2.1 Draft Final Design

- Draft Final 75% designs were submitted to the City for review in November. There was a meeting on Monday, December 14th between Weston & Sampson and multiple personnel from the City to go over the Draft Final 75% Riverwalk Design plans. Although the final 75% plans have been delayed several weeks as the City, Weston & Sampson continues to coordinate and incorporate feedback and make applicable changes to the draft 75% design, and we do not anticipate this to impact the overall project schedule.

#### 2.2 Final Design

- Final Design activities commenced at the end of November.
- The City and Weston & Sampson prepared for and hosted a virtual public meeting on January 12, 2021 and received feedback from the public on the draft designs of the Riverwalk. A summary of results from the on-line polling conducted throughout the virtual meeting and a copy of the presentation are included as separate documents.
- During the month, Weston & Sampson' Landscape Architectural Team continued to advance the final 75% design for the Riverwalk and adjacent public open space opportunities at 24 Caller Street, including but not limited to the following:
  - External meetings with City staff to facilitate incorporating the applicable feedback received from the public and making appropriate changes to the 75% design to finalize in early March 2021.
  - Concept design refinement for 24 Caller St parcel.
  - Coordination with structural team re: bridge and boardwalk, as well as updating plans for sheet pile / vegetated slope design for scour.
  - Site grading coordination
  - Stormwater management coordination
  - Environmental / MCP coordination
  - Construction documentation development and internal coordination with environmental, structural, electrical and civil teams.
  - Site visit to inspect southern slope conditions at 24 Caller
- The Final 75% design for the Riverwalk and adjacent public open space opportunities at 24 Caller Street was presented to the City on April 1, 2021.

### Task 3: Environmental Permitting

#### 3.1 Draft Permit Submittals

- Permitting activities commenced in December 2020.
- Permits are being drafted based on 75% draft design.
- Permitting team has been coordinating with MassDEP regarding permit submittal requirements and virtually with regulators and the City's Conservation Agent and City Engineer on February 25, 2021 to review the proposed stormwater management strategy for the project. The regulating community agreed that traditional infiltration through recharge would not work well at the Site given the contamination and shallow groundwater constraints in the area. Rachel Freed, Deputy Regional Director – Bureau of Water Resources (NERO), requested Weston & Sampson include a detailed discussion regarding the “maximum extent practical approach” when filing permits with MassDEP. Weston & Sampson also needs to address upland sheet flow and flood flow erosive concerns and how the vegetative slope stability will be managed.
- Continue to assemble of the required permitting materials, including but not limited to: Plan review and editing; Wetland delineation coordination; drafting of Notice of Intent, MEPA Environmental Notification Form, and U.S. ACOE Pre-Construction Notification; etc.
- As 75% design plans moves closer to finalization, updates will be made as needed.

#### 3.2 Finalize Permit Submittals

- No activities were conducted this month.

### Task 4: MPC Strategy for Soil Management and Cost Estimation

#### 4.1 MPC Strategy for Soil Management and Cost Estimation

- Coordination activities continued this month to support the 75% design, stormwater management and permitting associated with the proposed repairs to the canal wall and the construction of the Riverwalk. Weston & Sampson's environmental staff is assisting the permitting and design teams with respect to recommendations to address potential environmental (i.e. contamination) concerns associated with the canal wall and Riverwalk design, including but not limited to, updating preliminary cost estimates associated with Massachusetts Contingency Plan (310 CMR 40.000) compliance strategies and anticipated soil management/disposal requirements associated following the finalization of the 75% design.

#### 4.2 Hazmat Assessment of Foundations

- Weston & Sampson finalized the hazardous building materials assessment report and submitted to the City on December 22, 2020.

**Task 5: COMMUNITY ENGAGEMENT**

- The City and Weston & Sampson commenced community engagement planning and preparation activities in December 2020 and scheduled a public meeting for January 12, 2021.
- Notification to the public commenced on Monday, December 28, 2020.
- The City hosted the virtual public meeting on January 12, 2021.
- 72 people registered to attend the meeting and approximately 38 actively participated.
- At the meeting, topics discussed included project background, design progress updates, and programming options for 24 Caller Street. Attendees shared great feedback through polls and the Q&A sessions, which will inform final 75% designs of the Riverwalk.
- A summary of results from the on-line polling conducted throughout the virtual meeting and a copy of the presentation are included as separate documents.
- A video recording of the webinar will also be uploaded to the City's website.
- The City and Weston & Sampson are coordinating to schedule the next public meeting for later this spring.

**TASK 6. UPDATED RESILIENCY EVALUATION**

- The H&H report was finalized in FY20.

**TASK 7. PROGRAM MANAGEMENT**

- Monthly progress meetings and associated correspondence and/or coordination were conducted this month.
- Monthly progress reports have been submitted to EEA.
- Project currently on schedule and budget overall. The Final Draft 75% Riverwalk Design plans were delayed several weeks as the City and Weston & Sampson coordinate and incorporate feedback and make applicable changes to the 75% design. In addition, the first virtual public engagement was conducted in mid-January to receive feedback from the public on the draft final 75% designs of the Riverwalk. We do not anticipate these delays to impact the overall project schedule.

**SCOPE & BUDGET**

- No assistance from EEA is presently requested.
- A copy of the budget draw down / tracking table will be provided in future monthly progress reports as subtasks / tasks are completed and milestone deliverables are achieved.



## M E M O R A N D U M

**TO:** Brendan Callahan, Assistant Director of Planning – City of Peabody Massachusetts  
Michelle Rowden - Executive Office of Energy & Environmental Affairs (MassEEA)

**FROM:** Sarah DeStefano, Team Leader – Weston & Sampson

**DATE:** 5/3/21

**SUBJECT:** Monthly Progress Report  
Reporting Period of April 1, 2021 – April 30, 2021  
Report Number No. 15  
FY20-21 MVP Action Grant - Peabody North River Canal Resilient Wall and Riverwalk  
and Park – Phase II

---

Weston & Sampson is pleased to provide this summary of the status of engineering and design services related to the execution of the City of Peabody's FY20-FY21 North River Canal Resilient Wall and Riverwalk Grant Project (the Site), which is funded by the Massachusetts Executive Office of Energy & Environmental Affairs (MassEEA) through its Municipal Vulnerability Preparedness (MVP) Action Grant Program.

**TASK 1. SOUTH WALL STRUCTURAL DESIGN****1.1 Geotechnical**

- The geotechnical report was finalized in FY20.

**1.2 Geotechnical Survey**

- The survey base-map was finalized in FY20.

**1.3 Structural Analysis and Calculations**

- Weston & Sampson's Structural Team completed the design calculation package for the proposed North River Canal Wall, including sheet pile, helical pier/pile, boardwalk, and pedestrian timber bridge designs in FY20.

**1.3 Drawings and Technical Specifications**

- **Final South Wall 75% Design Plans**, including Drawings and Technical Specifications and **Quantity Takeoffs and Cost Estimate & Narrative** were provided to the City for submittal to EEA on September 30, 2020.

**1.5 Quantity Takeoffs and Cost Estimation**

- Completed September 2020 for submission to EEA.

## TASK 2: RIVERWALK 75% DESIGN

### 2.1 Draft Final Design

- Draft Final 75% designs were submitted to the City for review in November 2020.

### 2.2 Final Design

- Final Design activities commenced at the end of November.
- The City and Weston & Sampson prepared for and hosted a virtual public meeting on January 12, 2021 and received feedback from the public on the draft 75 %design of the Riverwalk.
- The Final 75% design for the Riverwalk and adjacent public open space opportunities at 24 Caller Street was presented to the City on April 1, 2021.
- During the month, Weston & Sampson’ Landscape Architectural Team met with City staff to review the Final 75% design and incorporated applicable feedback and made appropriate final changes to the 75% design.
- The design team coordinated with the Environmental Permitting Team for the required permitting application materials.
- Final 75% Design will be presented to the public at a virtual public meeting scheduled for Thursday May 20, 2021 at 6:30pm.

## Task 3: Environmental Permitting

### 3.1 Draft Permit Submittals

- Permitting activities commenced in December 2020.
- Permitting team has been coordinating with MassDEP regarding permit submittal requirements and virtually with regulators and the City’s Conservation Agent and City Engineer on February 25, 2021 to review the proposed stormwater management strategy for the project. The regulating community agreed that traditional infiltration through recharge would not work well at the Site given the contamination and shallow groundwater constraints in the area. Rachel Freed, Deputy Regional Director – Bureau of Water Resources (NERO), requested Weston & Sampson include a detailed discussion regarding the “maximum extent practical approach” when filing permits with MassDEP. Weston & Sampson also needs to address upland sheet flow and flood flow erosive concerns and how the vegetative slope stability will be managed.

### 3.2 Finalize Permit Submittals

- As the 75% Final design plans were finalized, the permitting team made any necessary updates and continued to assemble of the required permitting materials, including but not limited to: Plan review and editing; drafting of Notice of Intent, MEPA Environmental Notification Form, and U.S. ACOE Pre-Construction Notification; etc.
- On April 12, 2021, Weston & Sampson submitted the Final Permits (NOI, ENF, ACOE PCN) for the City’s review.

- Upon receipt of any applicable comments, Weston & Sampson will finalize the permits for submittal to the appropriate regulatory agencies.

#### **Task 4: MPC Strategy for Soil Management and Cost Estimation**

##### **4.1 MPC Strategy for Soil Management and Cost Estimation**

- Coordination activities continued this month to support the 75% design, stormwater management and permitting associated with the proposed repairs to the canal wall and the construction of the Riverwalk. Weston & Sampson's environmental staff is assisting the permitting and design teams with respect to recommendations to address potential environmental (i.e. contamination) concerns associated with the canal wall and Riverwalk design, including but not limited to, updating preliminary cost estimates associated with Massachusetts Contingency Plan (310 CMR 40.000) compliance strategies and anticipated soil management/disposal requirements associated following the finalization of the 75% design.

##### **4.2 Hazmat Assessment of Foundations**

- Weston & Sampson finalized the hazardous building materials assessment report and submitted to the City on December 22, 2020.

#### **Task 5: COMMUNITY ENGAGEMENT**

- The City and Weston & Sampson commenced it's first community engagement activities in December 2020, associated with a public meeting on January 12, 2021.
  - Notification to the public commenced on Monday, December 28, 2020.
  - The City hosted the virtual public meeting on January 12, 2021.
  - 72 people registered to attend the meeting and approximately 38 actively participated.
  - At the meeting, topics discussed included project background, design progress updates, and programming options for 24 Caller Street. Attendees shared great feedback through polls and the Q&A sessions, which will inform final 75% designs of the Riverwalk.
  - A summary of results from the on-line polling conducted throughout the virtual meeting and a copy of the presentation were previously provided.
  - A video recording of the webinar was uploaded to the City's website.
- The City and Weston & Sampson are planning and coordinating for the second public meeting for Thursday, May 20, 2021 at 6:30pm. Public notification activities commenced this month, including drafting materials associated with:
  - Eventbrite Registration
  - Meeting Flyer
  - E-Blast
  - Social Media post



#### **TASK 6. UPDATED RESILIENCY EVALUATION**

- The H&H report was finalized in FY20.

#### **TASK 7. PROGRAM MANAGEMENT**

- Monthly progress meetings and associated correspondence and/or coordination were conducted this month.
- Monthly progress reports have been submitted to EEA.
- Project currently on schedule and budget overall. Although the Final 75% Riverwalk Design plans were delayed several weeks as the City and Weston & Sampson coordinated and incorporated feedback and make applicable changes to the 75% design, we do not anticipate these delays to impact the overall project schedule.

#### **SCOPE & BUDGET**

- No assistance from EEA is presently requested.
- A copy of the budget draw down / tracking table will be provided in future monthly progress reports as subtasks / tasks are completed and milestone deliverables are achieved.

## M E M O R A N D U M

**TO:** Brendan Callahan, Assistant Director of Planning – City of Peabody Massachusetts  
Michelle Rowden - Executive Office of Energy & Environmental Affairs (MassEEA)

**FROM:** Sarah DeStefano, Team Leader – Weston & Sampson

**DATE:** 5/27/21

**SUBJECT:** Monthly Progress Report  
Reporting Period of May 1, 2021 – May 31, 2021  
Report Number No. 16  
FY20-21 MVP Action Grant - Peabody North River Canal Resilient Wall and Riverwalk  
and Park – Phase II

---

Weston & Sampson is pleased to provide this summary of the status of engineering and design services related to the execution of the City of Peabody's FY20-FY21 North River Canal Resilient Wall and Riverwalk Grant Project (the Site), which is funded by the Massachusetts Executive Office of Energy & Environmental Affairs (MassEEA) through its Municipal Vulnerability Preparedness (MVP) Action Grant Program.

**TASK 1. SOUTH WALL STRUCTURAL DESIGN****1.1 Geotechnical**

- The geotechnical report was finalized in FY20.

**1.2 Geotechnical Survey**

- The survey base-map was finalized in FY20.

**1.3 Structural Analysis and Calculations**

- Weston & Sampson's Structural Team completed the design calculation package for the proposed North River Canal Wall, including sheet pile, helical pier/pile, boardwalk, and pedestrian timber bridge designs in FY20.

**1.3 Drawings and Technical Specifications**

- **Final South Wall 75% Design Plans**, including Drawings and Technical Specifications and **Quantity Takeoffs and Cost Estimate & Narrative** were provided to the City for submittal to EEA on September 30, 2020.

**1.5 Quantity Takeoffs and Cost Estimation**

- Completed September 2020 for submission to EEA.

## **TASK 2: RIVERWALK 75% DESIGN**

### **2.1 Draft Final Design**

- Draft Final 75% designs were submitted to the City in November 2020.

### **2.2 Final Design**

- Final Design activities commenced at the end of November.
- The City and Weston & Sampson prepared for and hosted a virtual public meeting on January 12, 2021 and received feedback from the public on the draft 75 %design of the Riverwalk. Feedback received from the community was incorporated into the Final 75% design plans.
- The Final 75% design for the Riverwalk and adjacent public open space opportunities at 24 Caller Street was presented to the City on April 1, 2021.
- During the month, Weston & Sampson' Landscape Architectural Team incorporated applicable feedback and made appropriate final changes to the 75% design.
- The design team coordinated with the Environmental Permitting Team for the required permitting application materials.
- Final 75% Design was presented to the public at a virtual public meeting on Thursday May 20, 2021 at 6:30pm.

## **Task 3: Environmental Permitting**

### **3.1 Draft Permit Submittals**

- Permitting activities commenced in December 2020.
- Permitting team has been coordinating with MassDEP regarding permit submittal requirements and virtually with regulators and the City's Conservation Agent and City Engineer on February 25, 2021 to review the proposed stormwater management strategy for the project. The regulating community agreed that traditional infiltration through recharge would not work well at the Site given the contamination and shallow groundwater constraints in the area. Rachel Freed, Deputy Regional Director – Bureau of Water Resources (NERO), requested Weston & Sampson include a detailed discussion regarding the “maximum extent practical approach” when filing permits with MassDEP. Weston & Sampson also needs to address upland sheet flow and flood flow erosive concerns and how the vegetative slope stability will be managed.
- Draft permits were submitted to the City for review on April 12, 2021.

### **3.2 Final Permit Submittals**

- As the 75% Final design plans were finalized, the permitting team made any necessary updates and continued to assemble of the required permitting materials, including but not limited to: Plan review and editing; drafting of Notice of Intent, MEPA Environmental Notification Form, and U.S. ACOE Pre-Construction Notification; etc.



- On May 3 and May 10, 2021, the City provided comments on the Draft Permits. Weston & Sampson addressed the City's concerns on May 9 and May 11, 2021 respectively and submitted the Final Permits to the City for signature on May 11, 2021 (NOI, ENF, ACOE PCN). The City signed the permits on May 17, 2021.
- Weston & Sampson will submit the Final Permits to the appropriate regulatory agencies upon authorization from the City of Peabody and before the completion of the project in June 2021.

#### **Task 4: MPC Strategy for Soil Management and Cost Estimation**

##### **4.1 MPC Strategy for Soil Management and Cost Estimation**

- Weston & Sampson's environmental team is in the process of finalizing updated cost estimates associated with Massachusetts Contingency Plan (310 CMR 40.000) compliance strategies and anticipated soil management/disposal requirements associated with the finalization of the 75% design.
- A memo to the City documenting the MCP strategy for soil management and associated cost estimates will be submitted to the City at the beginning of June.

##### **4.2 Hazmat Assessment of Foundations**

- Weston & Sampson finalized the hazardous building materials assessment report and submitted to the City on December 22, 2020.

#### **Task 5: COMMUNITY ENGAGEMENT**

- The City and Weston & Sampson commenced its first community engagement activities in December 2020, associated with a public meeting on January 12, 2021.
  - Notification to the public commenced on Monday, December 28, 2020.
  - The City hosted the virtual public meeting on January 12, 2021.
  - 72 people registered to attend the meeting and approximately 38 actively participated.
  - At the meeting, topics discussed included project background, design progress updates, and programming options for 24 Caller Street. Attendees shared great feedback through polls and the Q&A sessions, which will inform final 75% designs of the Riverwalk.
  - A summary of results from the on-line polling conducted throughout the virtual meeting and a copy of the presentation were previously provided.
  - A video recording of the webinar was uploaded to the City's website.
- The City and Weston & Sampson conducted the second public meeting for this grant project on Thursday, May 20, 2021 at 6:30pm.
  - Notification to the public commenced the week of May 10, 2021, including social media postings on May 18, 2021.
  - 19 people registered to attend the meeting and approximately 11 people actively participated in the meeting, in addition to City and Weston & Sampson staff.

- At the meeting, topics discussed included a brief project re-cap, an update on the overall site plans, the design of 24 Caller Street, and next steps. Attendees shared feedback through polls and the Q&A sessions, which will be used to inform final 100% designs of the Riverwalk so that the park's features consider the viewpoints and interests of the community.
- A summary of results from the on-line polling conducted throughout the virtual meeting and a copy of the presentation are provided as a separate attachment.
- A video recording of the webinar will be uploaded to the City's website.

#### **TASK 6. UPDATED RESILIENCY EVALUATION**

- The H&H report was finalized in FY20.

#### **TASK 7. PROGRAM MANAGEMENT**

- Monthly progress meetings and associated correspondence and/or coordination were conducted this month.
- Monthly progress reports have been submitted to EEA.
- Project currently on schedule and budget overall. Although the Final 75% Riverwalk Design plans, and associated deliverables were delayed several weeks as the City and Weston & Sampson coordinated and incorporated feedback and make applicable changes to the 75% design, we do not anticipate these delays to impact the overall project schedule.

#### **SCOPE & BUDGET**

- No assistance from EEA is presently requested.
- A copy of the budget draw down / tracking table will be provided in future monthly progress reports as subtasks / tasks are completed and milestone deliverables are achieved.