



Salem State University Alumni House

262A Loring Avenue
Salem, MA 01970

For Official Use Only

Contact Information

Main Phone: (978) 542-6000

Fax: (978) 542-7064

President: Patricia Maguire Meservey

Phone: (978) 542-6134

Alternate Phone: (978) 998-9363

Email: pmeservey@salemstate.edu

Executive Vice

President: Stanley P. Cahill

Phone: (978) 542-6402

Alternate Phone: (508) 541-1805

Email: scahill@salemstate.edu

Campus Police: William G Anglin

Title: Chief of Police

Phone: (978) 542-6002

Alternate Phone: (978) 758-2857

Email: wanglin@salemstate.edu

Police Chief: Paul F Tucker

Dispatch: 911

Alternate Phone: (978) 744-0171

Email: admin@salempd.net

Local Hospital: North Shore Medical Center

Phone: (978) 741-1200

Building Coordinator

1: Diane Shahin

Phone: (978) 542-7591

Alternate Phone:

Email: dshahin@salemstate.edu

Building Coordinator

2: James Glynn

Phone: (978) 542-7519

Alternate Phone: (508) 259-0117

Email: jglynn@salemstate.edu

Dean of Students: James G Stoll

Phone: (978) 542-6401

Alternate Phone: (617) 448-4460

Email: jstoll@salemstate.edu

Director of Facilities: Daniel J Burke

Phone: (978) 542-6096

Alternate Phone: (978) 423-6742

Email: dburke@salemstate.edu

Fire Chief: David W Cody

Dispatch: 911

Alternate Phone: (978) 744-6990

Email: dcody@salem.com

Building Information

Year Built: 1916

Number of Students:

Longitude: 70Deg 53' 37.55"W

Floor Area: 8,677 Sq.Ft.

Number of Staff:

Latitude: 42Deg 29' 33.48"N



Salem State University Alumni House

262A Loring Avenue
Salem, MA 01970

For Official Use Only

Utility Information

	<u>Provider</u>	<u>Phone</u>	<u>Alternate Phone</u>
Electrical	National Grid	(800) 465-1212	
Gas	National Grid	(800) 465-1212	
Telephone	Verizon		
Water	City of Salem	(978) 744-3302	
Sewer	City of Salem	(978) 744-3302	



Salem State University Alumni House

262A Loring Avenue
Salem, MA 01970

For Official Use Only

Building Features

Alarm and Monitoring Systems		
Closed Circuit Cameras	No	
Security Alarm System	Yes	
Fire Alarm System	Yes	Simplex
Call Box	Yes	#5514
Knox Box	No	
Motion Detection Devices	No	
Communication Systems		
Cable TV Access	Yes	
Intercom System	No	
Portable Radios	No	
Phones in Rooms	Yes	
Hazards		
Hazardous Materials	No	
Building Systems		
Electrical Shutoff	Yes	
Gas Shutoff	Yes	Right of Door 1 on Side D
Water Shutoff	Yes	
Other		
Roof Access	No	
Roof Type	Asphalt Shingle	
Wall Construction	Wood and Brick Exterior; Concrete and Drywall Interior	

School Name:	Salem State University
Building Name:	Alumni House
Address:	262A Loring Avenue Salem, MA 01970

For Official Use Only

1st Floor

1st Floor Plan

Side B

Side D

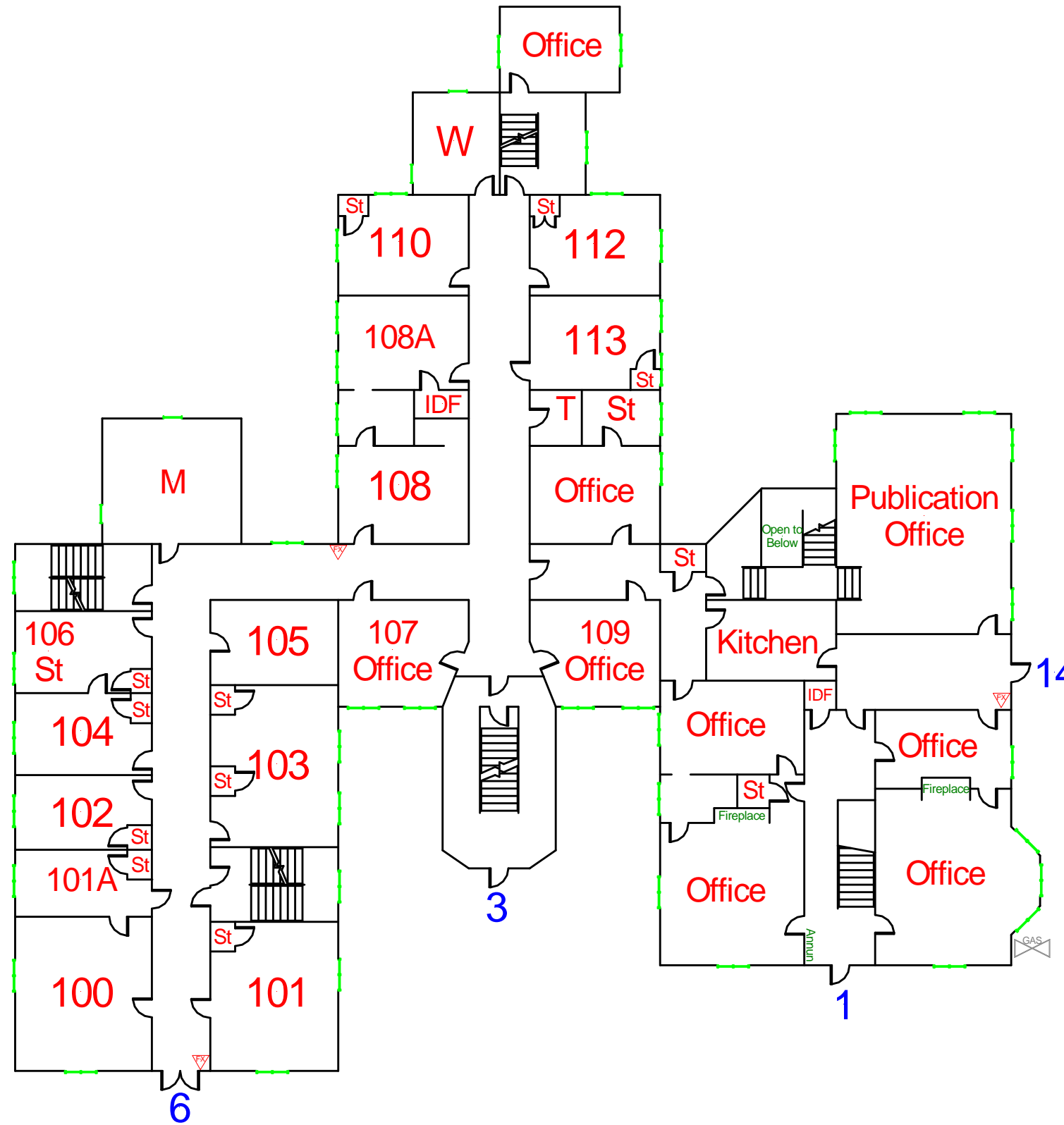

Legend

- Camera
- Chair Lift
- Bathrooms: Mens, Womens, Unisex
- Storage
- Window
- Elevator
- Emergency Phone
- Knox Box
- Water Shutoff
- Sprinkler Shutoff
- Electrical Shutoff
- Gas Shutoff
- Ramp
- Emergency Generator
- Fire Alarm Control Panel
- Halon System
- Fire Dept. Connection
- Fire Extinguisher

Side A

School Name:	Salem State University
Building Name:	Alumni House
Address:	262A Loring Avenue Salem, MA 01970

For Official Use Only





2nd Floor

Side B

Side C

Side D

Legend

-  Camera
-  Chair Lift
-  Bathrooms: Mens, Womens, Unisex
-  Storage
-  Window
-  Elevator
-  Emergency Phone
-  Knox Box
-  Water Shutoff
-  Sprinkler Shutoff
-  Electrical Shutoff
-  Gas Shutoff
-  Ramp
-  Emergency Generator
-  Fire Alarm Control Panel
-  Halon System
-  Fire Dept. Connection
-  Fire Extinguisher

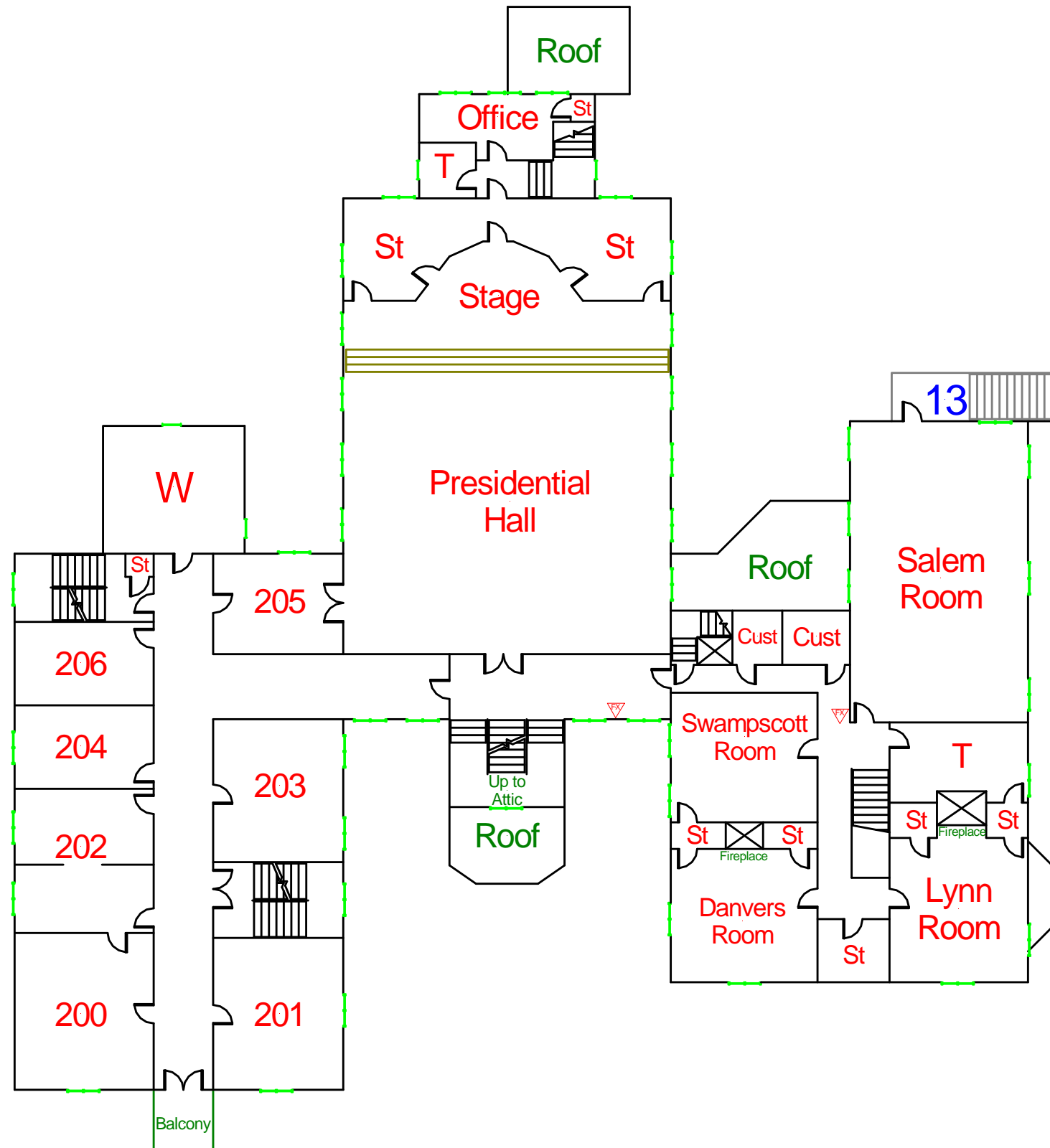

2nd Floor Plan

Side A

School Name:	Salem State University
Building Name:	Alumni House
Address:	262A Loring Avenue Salem, MA 01970

For Official Use Only

















3rd Floor

Side B

Side C

Side D

Legend

-  Camera
-  Chair Lift
-  Bathrooms: Mens, Womens, Unisex
-  Storage
-  Window
-  Elevator
-  Emergency Phone
-  Knox Box
-  Water Shutoff
-  Sprinkler Shutoff
-  Electrical Shutoff
-  Gas Shutoff
-  Ramp
-  Emergency Generator
-  Fire Alarm Control Panel
-  Halon System
-  Fire Dept. Connection
-  Fire Extinguisher

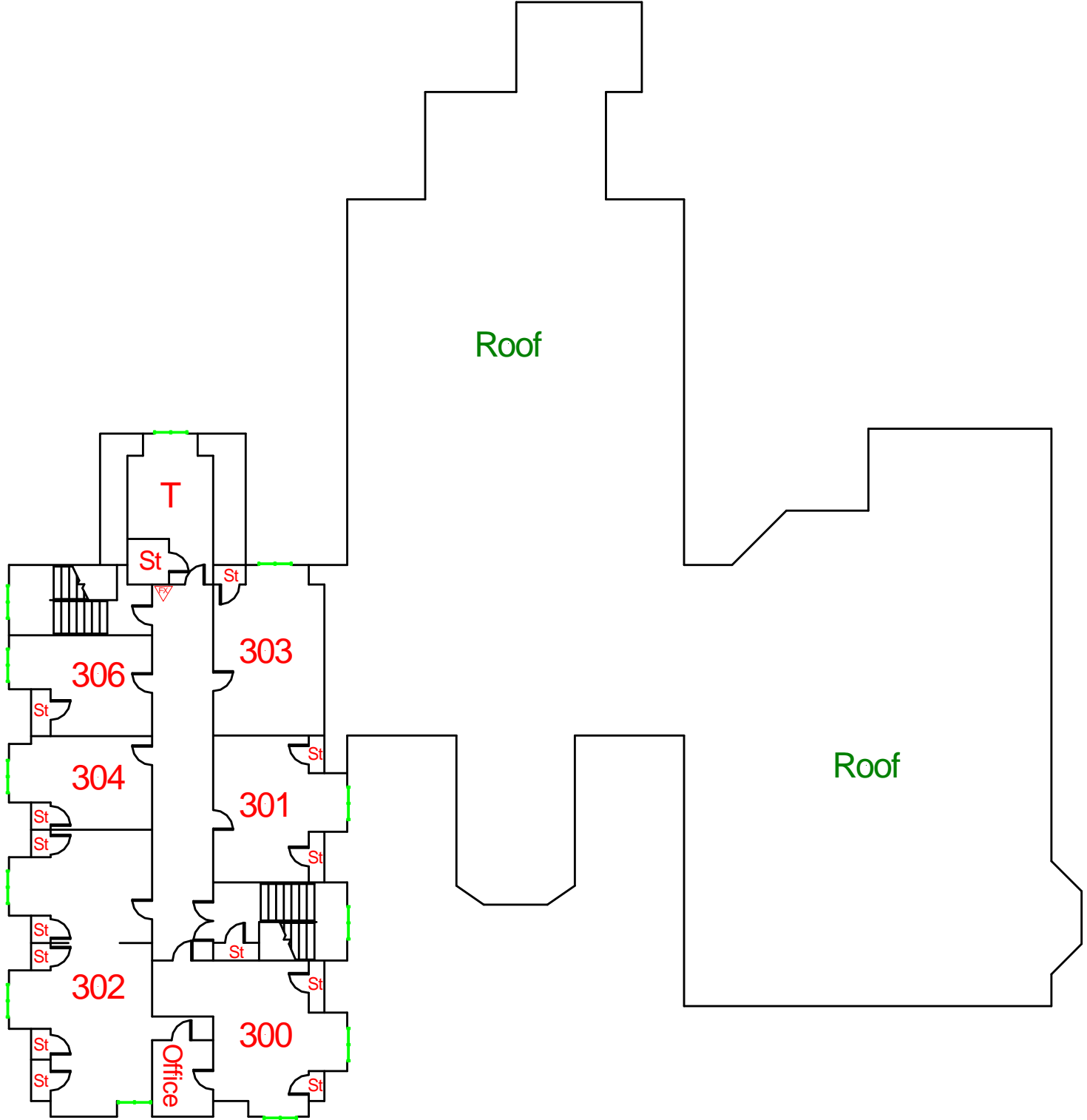

3rd Floor Plan



School Name:	Salem State University
Building Name:	Alumni House
Address:	262A Loring Avenue Salem, MA 01970

For Official Use Only

Basement

Side B

Side C

Side D

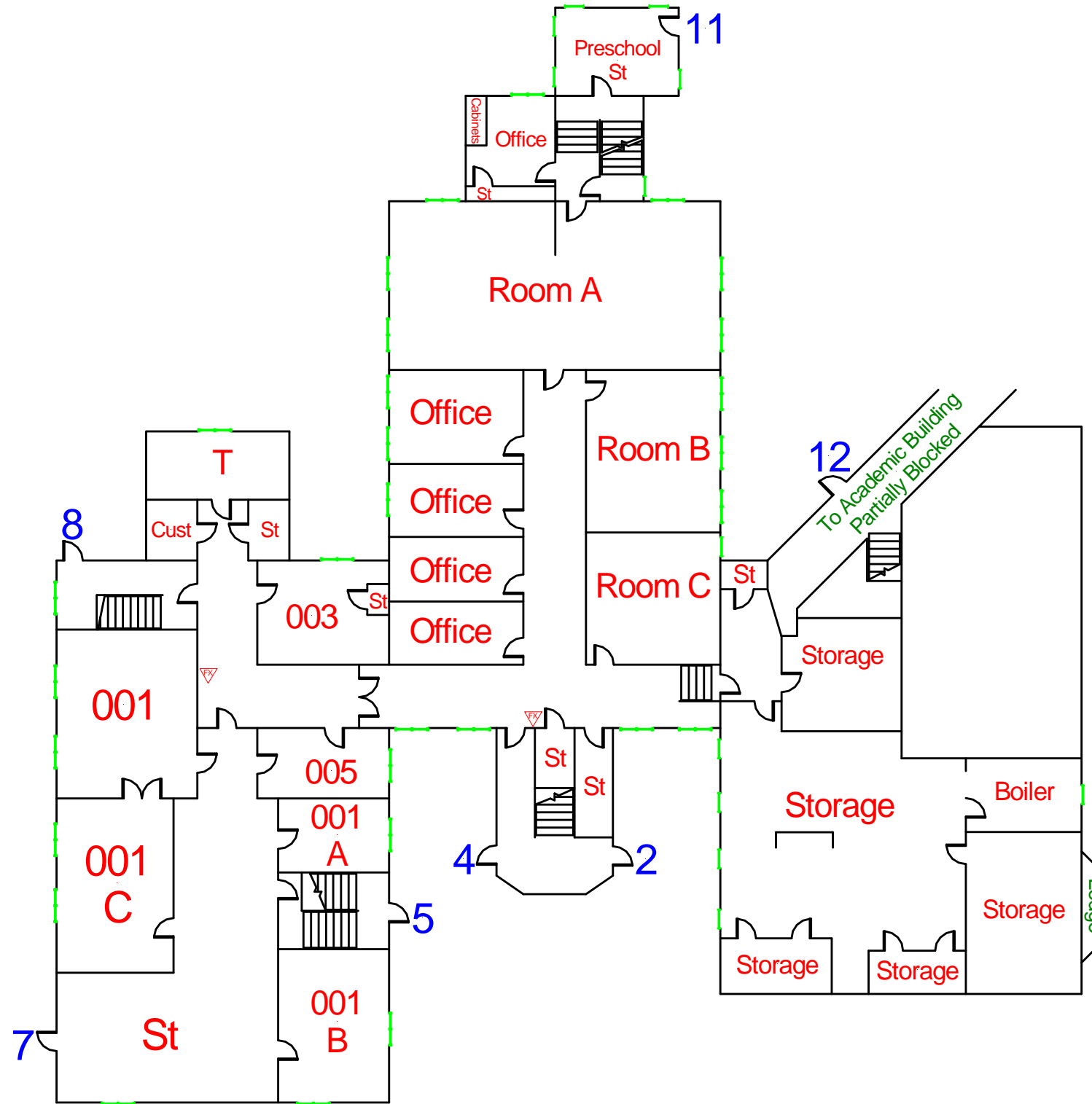

Legend

- Camera
- Chair Lift
- Bathrooms: Mens, Womens, Unisex
- Storage
- Window
- Elevator
- Emergency Phone
- Knox Box
- Water Shutoff
- Sprinkler Shutoff
- Electrical Shutoff
- Gas Shutoff
- Ramp
- Emergency Generator
- Fire Alarm Control Panel
- Halon System
- Fire Dept. Connection
- Fire Extinguisher

Side A

Basement Floor Plan

School Name:	Salem State University
Building Name:	Alumni House
Address:	262A Loring Avenue Salem, MA 01970

For Official Use Only

Sub-Basement

Side B

Side C

Side D

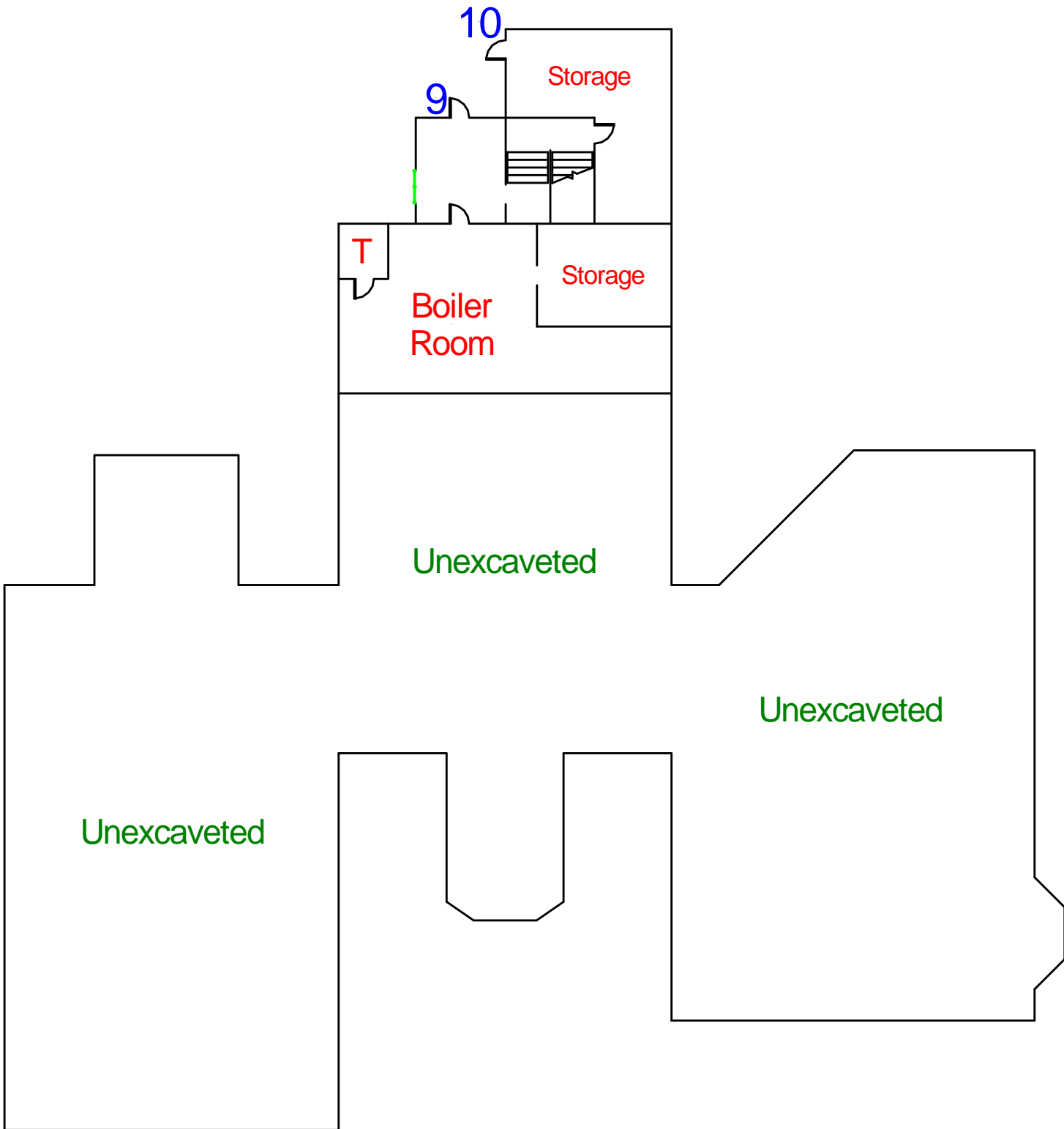

Legend

- Camera
- Chair Lift
- Bathrooms: Mens, Womens, Unisex
- Storage
- Window
- Elevator
- Emergency Phone
- Knox Box
- Water Shutoff
- Sprinkler Shutoff
- Electrical Shutoff
- Gas Shutoff
- Ramp
- Emergency Generator
- Fire Alarm Control Panel
- Halon System
- Fire Dept. Connection
- Fire Extinguisher



Side A

Sub-Basement Floor Plan



Salem State University Alumni House

262A Loring Avenue
Salem, MA 01970

For Official Use Only

Aerial Photography; Side A





Salem State University Alumni House

262A Loring Avenue
Salem, MA 01970

For Official Use Only

Side A Photographs



Side A, From B



Side A, From D



Side A, Door 1



Side A, Door 2





Salem State University Alumni House

262A Loring Avenue
Salem, MA 01970

For Official Use Only

Side A Photographs



Side A, Door 3



Side A, Door 4



Side A, Door 5



Side A, Door 6





Salem State University Alumni House

262A Loring Avenue
Salem, MA 01970

For Official Use Only

Aerial Photography; Side B





Salem State University Alumni House

262A Loring Avenue
Salem, MA 01970

For Official Use Only

Side B Photographs



Side B, From A



Side B, From C



Side B, Door 7





Salem State University Alumni House

262A Loring Avenue
Salem, MA 01970

For Official Use Only

Aerial Photography; Side C





Salem State University Alumni House

262A Loring Avenue
Salem, MA 01970

For Official Use Only

Side C Photographs



Side C, Door 8



Side C, Door 9



Side C, Door 10



Side C, Door 11





Salem State University Alumni House

262A Loring Avenue
Salem, MA 01970

For Official Use Only

Side C Photographs



Side C, Door 12



Side C, Door 13





Salem State University Alumni House

262A Loring Avenue
Salem, MA 01970

For Official Use Only

Aerial Photography; Side D





Salem State University Alumni House

262A Loring Avenue
Salem, MA 01970

For Official Use Only

Side D Photographs



Side D, From A



Side D, Door 14

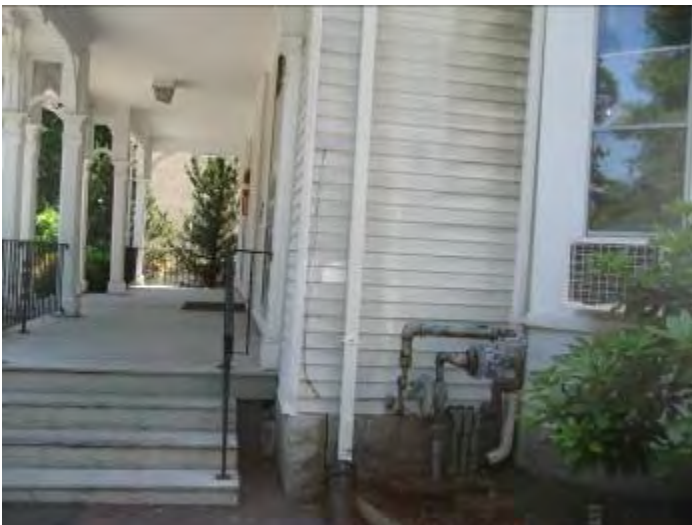

Side D, Gas Main

